



TDSUSB2

Universal Serial Bus Measurement Package

077-0015-03

This document supports software version 3.0.3 and above.

www.tektronix.com

Copyright © Tektronix. All rights reserved. Licensed software products are owned by Tektronix or its suppliers and are protected by United States copyright laws and international treaty provisions.

Tektronix products are covered by U.S. and foreign patents, issued and pending. Information in this publication supercedes that in all previously published material. Specifications and price change privileges reserved.

TEKTRONIX and TEK are registered trademarks of Tektronix, Inc.

TDSUSB2 Compliance Test Software Online Help, 077-0015-03, Version 3.0.6.

Contacting Tektronix:

Tektronix, Inc.

14200 SW Karl Braun Drive or P.O. Box 500

Beaverton, OR 97077 USA

For product information, sales, service, and technical support:

- In North America, call 1-800-833-9200.
- Worldwide, visit www.tektronix.com to find contacts in your area.

Table of Contents

General Safety Summary	xi
Introduction	1
Welcome to the TDSUSB2 Universal Serial Bus Measurements Package	1
Online Help and Related Documentation	2
Using Online Help	2
Printing from the Online Help	4
Conventions	4
Related Documentation.....	5
Feedback	6
General information	6
Application specific information.....	6
Getting Started	7
Introduction and Product Description.....	7
Compatibility	8
Requirements and Restrictions	8
Accessories	8
Optional Accessories.....	8
Installation	11
Setting up the Instrument to Take Measurements.....	11
Recommended Instruments and Probes.....	11
Installing the Application.....	11
Deskewing	12
Deskewing the Probes and Channels.....	12
Deskewing Probes and Channels on the supported Instruments	12
Operating Basics.....	19
About Basic Operations	19
Application Interface	19
Application Interface Menu Controls	19
Basic Instrument Functions	20
Using Basic Oscilloscope Functions	20
Minimizing and Maximizing the Application	20

Application Directories and File Names	21
File Name Extensions.....	21
Returning to the Application	21
Exiting the Application	22
Setting up the Software to take Measurements.....	22
Description of the Test Fixture.....	22
Setting Up the Device Details	23
Setting up the Software	24
Setting Preferences.....	24
Table of Measurements and Options	27
Low Speed and Full Speed Measurements.....	27
High Speed Measurements.....	27
Selecting a Measurement	28
Signal Quality Check	29
Inrush Current Check.....	30
Droop Measurement	30
Receiver Sensitivity Measurement	31
Chirp Measurement.....	33
Monotonic Property	34
Configuring a Measurement	34
Configure Limits.....	35
Configuring Signal Quality Measurements	35
Configuring Inrush Current Measurements	36
Configuring Droop Measurements	36
Configuring Receiver Sensitivity Measurements	37
Configuring Chirp Measurement	37
Configuring Reset from High Speed Measurement.....	39
Configuring Resume Measurement	40
Configuring Suspend Measurement.....	41
Configuring Reset from Suspend Measurement	42
Configuring Packet Parameter Measurement	43
Packet Parameter Measurement.....	44
Suspend Measurement	45

Resume Measurement.....	45
Reset from Suspend Measurement.....	46
Reset from High Speed Measurement	48
Taking Measurements.....	49
Acquiring Data.....	49
Control Menu Options	51
Viewing Results.....	51
Eye Diagram.....	52
Waveform Plot	54
Report Generation.....	57
Generating Reports.....	57
Viewing Reports.....	58
TSV File Generator	58
TSV file format description.....	59
CSV file format description	59
Saving and Recalling Setups.....	60
How to Save and Recall a Setup	60
Saving a Setup.....	60
Recalling a Saved Setup.....	60
Recalling the Default Setup.....	61
Recently Saved Setup.....	61
Recently Recalled Setup.....	61
Tutorial	63
Introduction to the Tutorial.....	63
Starting the Application.....	63
Recalling a .tsv File	63
Taking a Full Speed Signal Quality Measurement	64
Taking a Low Speed Inrush Current Measurement	67
Taking a High Speed Signal Quality Measurement.....	69
Taking a Low Speed Signal Quality Measurement	72
Application Examples.....	77
Full Speed Signal Quality Tests for Downstream Testing.....	77

Specifying the Equipment-Full Speed Signal Quality
Downstream Tests77

Typical Equipment Setup-Full Speed Signal Quality
Downstream Tests77

Selecting and Configuring Measurements-Full Speed Signal
Quality Tests78

Configuring the Measurement.....79

Viewing Results-Full Speed Signal Quality Tests80

Generating Reports-Full Speed Signal Quality Tests.....81

Droop Test for Ports of Hub82

Specifying the Equipment-Low Speed Droop Tests82

Typical Equipment Setup-Low Speed Droop Tests82

Selecting and Configuring Measurements-Droop Tests.....84

Configuring the Measurement.....84

Viewing Results-Droop Tests84

Generating Reports-Droop Tests.....85

Full Speed Signal Quality Tests for Upstream Testing.....86

Specifying the Equipment-Full Speed Signal Quality Tests for
Upstream Testing86

Typical Equipment Setup-Full Speed Signal Quality Tests for
Upstream Testing86

Selecting and Configuring Measurements-Full Speed Signal
Quality Tests for Upstream Testing87

Configuring the Measurement.....88

Viewing Results-Full Speed Signal Quality Tests for
Upstream Testing90

Generating Reports-Full Speed Signal Quality Tests for
Upstream Testing91

Inrush Current Test for a Device91

Specifying the Equipment-Full Speed Inrush Current Test91

Typical Equipment Setup-Inrush Current Test.....91

Selecting and Configuring Measurements-Inrush Current Test.....93

Configuring the Measurement.....93

Viewing Results-Inrush Current Test.....	93
Generating Reports-Inrush Current Test	94
Signal Quality Tests for High Speed Devices.....	95
Specifying the Equipment-Signal Quality Tests for High Speed Devices for Upstream Testing	95
Typical Equipment Setup-Signal Quality Tests for High Speed Devices for Upstream Testing	95
Selecting and Configuring Measurements-Signal Quality Tests for High Speed Devices for Upstream Testing	96
Configuring the Measurement.....	97
Viewing Results-Signal Quality Tests for High Speed Devices for Upstream Testing	97
Generating Reports-Signal Quality Tests for High Speed Devices for Upstream Testing	100
Packet Parameter Measurement.....	101
Specifying the Equipment-Packet Parameter Measurement	101
Typical Equipment Setup-Packet Parameter Measurement	101
Set up the Oscilloscope for High Speed Host	101
Selecting and Configuring Measurement-Packet Parameter Measurement	111
Configuring the Measurement.....	112
Viewing Results-Packet Parameter Measurement.....	112
Generating Reports-Packet Parameter Measurement.....	113
Resume Measurement.....	115
Specifying the Equipment-Resume Measurement	115
Typical Equipment Setup-Resume Measurement	116
Selecting and Configuring Measurement-Resume.....	117
Configuring the Measurement.....	117
Viewing Results-Resume Measurement	118
Generating Reports-Resume Measurement.....	118
Reset from Suspend Measurement.....	121
Specifying the Equipment-Reset from Suspend Measurement	121
Typical Equipment Setup-Reset from Suspend Measurement	121

Selecting and Configuring Measurement-Reset from Suspend	
Measurement	122
Configuring the Measurement.....	123
Viewing Results-Reset from Suspend Measurement	123
Generating Reports-Reset from Suspend Measurement.....	124
Suspend Measurement	126
Specifying the Equipment-Suspend Measurement.....	126
Typical Equipment Setup-Suspend Measurement.....	127
Selecting and Configuring Measurement-Suspend Measurement	128
Configuring the Measurement.....	128
Viewing Results-Suspend Measurement.....	129
Generating Reports-Suspend Measurement	130
Reset from High Speed Measurement	132
Specifying the Equipment-Reset from High Speed Measurement.....	132
Typical Equipment Setup-Reset from High Speed Measurement.....	132
Selecting and Configuring Measurement-Reset from High Speed	
Measurement	133
Configuring the Measurement.....	134
Viewing Results-Reset from High Speed Measurement	134
Generating Reports-Reset from High Speed Measurement	136
Chirp Measurement.....	138
Specifying the Equipment-Chirp.....	138
Typical Equipment Setup-Chirp.....	138
Selecting and Configuring Measurement-Chirp.....	140
Configuring the Measurement.....	141
Viewing Results-Chirp	141
Generating Reports-Chirp	143
R-GPIB Commands	147
About the R-GPIB Program.....	147
R-GPIB Reference Materials	147
Introduction to the R-GPIB Commands	148
Guidelines to R-GPIB Programming	148
Launching the Application Using R-GPIB	149

Variable: Value Command	150
Variable: Value TDSUSB2 Command Arguments and Queries- Application.....	150
Variable: Value TDSUSB2 Command Arguments and Queries- Sequencer	150
Variable: Value TDSUSB2 Command Arguments and Queries- Save/Recall.....	151
Variable: Value TDSUSB2 Command Arguments and Queries- Report Generation	151
Variable: Value TDSUSB2 Command Arguments and Queries- Results ...	152
Sample Program.....	156
Reference	165
Shortcut Keys.....	165
USB2.0 Specifications	166
Low Speed.....	166
Full Speed.....	167
High Speed	168
Inrush Current Check	168
Droop Test.....	169
Error Codes and Warnings.....	169
Settings for the supported Instruments	176
Upstream Setups for Low Speed signals	176
Upstream Setups for Full Speed signals.....	176
Downstream Setups for Low Speed signals	177
Downstream Setups for Full Speed signals.....	177
Upstream Setup for High Speed signals.....	177
Inrush Setup.....	177
Droop Setup.....	178
Chirp Device EL_28, EL_29 EL_31 setup	178
Chirp Host EL_33, EL_34 setup	178
Chirp Host EL_35 setup	178
Suspend Setup	179
Resume Setup.....	179
Reset from High Speed	179

Reset from Suspend.....	179
Packet Parameter	180
Parameters	181
About Application Parameters.....	181
File Menu Parameters	181
Save and Recall Menu Parameters.....	181
Preferences Parameters	181
Measurement Menus.....	182
Measurement Parameters	182
Configure Menu.....	183
Configure Signal Quality Measurements Parameters	183
Configure.....	183
Source.....	184
Configure Inrush Current Measurement Parameters	184
Configure.....	184
Source.....	184
Configure Droop Test Parameters	185
Configure.....	185
Source.....	185
Configure Receiver Sensitivity.....	185
Configure Suspend, Reset from High Speed, Resume, Reset from Suspend	185
Configure Packet Parameter	186
Configure Chirp	186
Results Menus.....	186
Utilities Menus.....	187
Deskew	187
Report Generator Menu Parameters.....	187
TSV File Generator Menu Parameters.....	188
Help Menu	188
Control Menu.....	188
Control Menu Parameters.....	188

Measurement Algorithms	189
About Measurement Algorithms	189
Cross-Over Voltage for Low Speed and Full Speed Signals	189
Cross-Over Voltage for High-Speed Signals	191
Signal Rate	192
EOP Width Calculation	193
Consecutive and Paired Jitter.....	194
Eye Diagram	195
Eye Violation	195
Inrush Current.....	196
Droop Test	196
Receiver Sensitivity Test	197
Chirp Test for a Device.....	197
Host Chirp Test.....	198
Monotonic Property Test	198
Rise Time.....	199
Fall Time.....	199
Packet Parameter.....	200
Resume	201
Suspend.....	201
Reset from Suspend	202
Reset from High Speed	203
Equipment Setup for Tests.....	204
Low Speed Downstream Signal Quality Host Equipment Setup	204
Low Speed Signal Quality for HUB Downstream	205
Full Speed Signal Quality HUB Downstream Setup.....	206
Full Speed Downstream Host Equipment Setup	208
Full Speed Upstream Signal Quality Setup.....	209
High Speed Device Signal Quality Setup.....	211
Chirp Test Equipment Setup	212
Receiver Sensitivity Setup	214
Procedural steps.....	215
Resume Test Equipment Setup.....	218
Reset from Suspend Test Equipment Setup	219

Suspend Test Equipment Setup220

Reset from High Speed Test Equipment Setup221

Packet Parameter Test Equipment Setup222

Test Fixture Setup222

Set up the Oscilloscope for High Speed Host223

Glossary 233

General Safety Summary

Review the following safety precautions to avoid injury and prevent damage to this product or any products connected to it. To avoid potential hazards, use this product only as specified.

Only qualified personnel should perform service procedures.

While using this product, you may need to access other parts of the system. Read the *General Safety Summary* in other system manuals for warnings and cautions related to operating the system.

To Avoid Fire or Personal Injury:

Connect and Disconnect Properly: Do not connect or disconnect probes or test leads while they are connected to a voltage source.

Observe All Terminal Ratings: To avoid fire or shock hazard, observe all ratings and markings on the product. Consult the product manual for further ratings information before making connections to the product.

Do Not Operate With Suspected Failures: If you suspect there is damage to this product, have it inspected by qualified service personnel.

Symbols and Terms: The following terms and symbols may appear in the online help.



WARNING: Warning statements identify conditions or practices that could result in injury or loss of life.



CAUTION: Caution statements identify conditions or practices that could result in damage to this product or other property.

Terms on the Product: The following terms may appear on the product:

- DANGER indicates an injury hazard immediately accessible as you read the marking.
- WARNING indicates an injury hazard not immediately accessible as you read the marking.
- CAUTION indicates a hazard to property including the product.

Symbols on the Product: The following symbol (s) may appear in the product:



CAUTION Refer to Help

Introduction

Welcome to the TDSUSB2 Universal Serial Bus Measurements Package

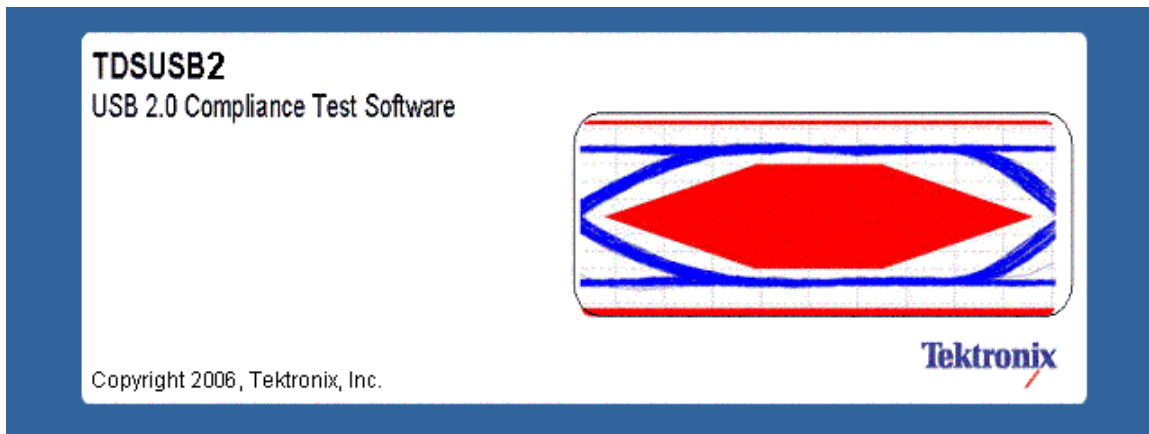

TDSUSB2 Universal Serial Bus Measurements Package is a Sun Java-based application that runs on the supported instruments connected to a PC. You can use the application software with the compliance test fixture to take the following measurements:

- Signal Quality
- Inrush
- Droop
- Drop (supported by the test fixture only)
- Receiver Sensitivity
- Impedance Measurement using Time Domain Reflectometry (TDR), supported by the application only with the test fixture
- Chirp measurements
- Packet Parameter
- Resume
- Reset from Suspend
- Reset from High Speed
- Suspend

The application runs on the oscilloscope and displays on the lower part of the screen. The oscilloscope application runs on the upper part of the screen.

Online Help and Related Documentation

You can access the information on how to operate the application and the oscilloscope through the following related documents and online help.

Click **Start > Programs > TekApplications > TDSUSB2 > Help** to access the Online Help.

Click **Start > Programs > TekApplications > TDSUSB2 > Help (PDF Version)** to access the PDF version of the Online Help.

Using Online Help

Online help has many advantages over a printed manual because of advanced search capabilities. Select Help on the right side of the application menu bar to bring up the help file.

The main (opening) Help screen shows a series of book icons and three tabs along the top menu, each of which offers a unique mode of assistance:

- **Tables of Contents (TOC) tab** -organizes the Help into book-like sections. Select a book icon to open a section; select any of the topics listed under the book.
- **Index tab** - enables you to scroll a list of alphabetical keywords. Select the topic of interest to bring up the appropriate help page.
- **Search tab** - allows a text-based search. Follow these steps:
 1. Type the word or phrase you want to find in the search box
 2. Select some matching words in the next box to narrow your search
 3. Choose a topic in the lower box, and then select the Display button
 - To print a topic, select the Print button from the Help Topics menu bar.
 - Select Options from the menu bar for other commands, such as Refresh.
 - Select the Back button to return to the previous help window. Use the Hyperlink to jump from one topic to another. If the Back button is grayed out or a jump is not available, choose the Help Topics button to return to the originating help folder.

- Browse buttons (Next >> and Previous <<) allow you to move forward and backward through topics in the order of the Table of Contents (TOC).
- Sometimes you will see the word, **Note**, in the topic text. This indicates important information.
- Certain aspects of the online help are unique to applications that run on the oscilloscope.

***Note:** Green-underlined text indicates a jump (hyperlink) to another topic. Select the green text to jump to the related topic. For example, select the green text to jump to the topic on [Online Help and Related Documentation](#) and the Back button to return to this topic page.*



Tip You can tell when the cursor is over an active hyperlink (button, jump, or popup), because the cursor arrow changes to a small hand.

***Note:** The light bulb and the word **Tip** in the graphic  **Tip**. This graphic indicates additional information to help you function faster or more efficiently.*

Printing from the Online Help

Some online help topics have color in the examples of the displayed application. If you want to print this type of topic on a monochrome printer, some information may not print because of certain colors. Instead, you should print the topic from the PDF (portable document format) file that corresponds to the Online Help. You can find the file in the Documents directory on the *Optional Applications Software on Windows-Based Oscilloscopes CD-ROM*. The figures of application menus in the PDF file are gray scale and all of the information prints.

Conventions

Online help uses the following conventions:

- Refers to the software part of the TDSUSB2 Universal Serial Bus Measurements Package as the TDSUSB2 application or as the application
- When steps require a sequence of selections using the application interface, the ">" delimiter marks each transition between a menu and an option. For example, one of the steps to recall a setup file would appear as File> Recall
- Unit under test (UUT) refers to the USB2.0 device under test, hub under test, host under test, and port under test
- SOF refers to the Start of Frames exchanged between the host controller and the device when the device is connected to the host and enumerated by the test mode software

Related Documentation

In addition to the Online Help, you can access other information on how to operate the oscilloscope through the following related documents:

- **Instrument Information:** The user manual for your oscilloscope provides general information on how to operate the oscilloscope
- **Programmer Information:** The online help for your oscilloscope provides details on how to use GPIB commands to control the oscilloscope



Tip You can also download the following files, which contain programmer information and examples, from the Tektronix Web site.

- *Optional Applications Software on Windows-Based Oscilloscopes Installation Manual*
- *TDSUSB2 Universal Serial Bus Measurements Package Reference*
- *TDSUSBF USB2.0 Compliance Test Fixture Instructions*

For more information on USB2.0 specifications, visit www.usb.org.

Refer to the *Optional Applications Software on Windows-Based Oscilloscopes Installation Manual* for the following information:

- Software warranty
- List of all available applications, compatible instruments, and relevant software and firmware version numbers
- Applying a new label
- Installing an application
- Enabling an application
- Downloading updates from the Tektronix Web site

You can find a PDF (portable document format) file of this document in the Documents directory on the *Optional Applications Software on Windows-Based Oscilloscopes CD-ROM*. The CD booklet only contains information on installing the application from the CD and on how to apply a new label.

Feedback

Tektronix values your feedback on our products. To help us serve you better, please send us your suggestions, ideas, or comments about your oscilloscope.

Direct your feedback via email to techsupport@tektronix.com or FAX at (503) 627-5695 and include the following information. Please be as specific as possible.

General information

- Instrument model number and hardware options, if any
- Probes used
- Your name, company, mailing address, phone number, FAX number
- Please indicate if you would like to be contacted by Tektronix about your suggestion or comments

Application specific information

- Software version number
- Description of the problem such that technical support can duplicate the problem
- If possible, save the oscilloscope and application setup files as .set files
- If possible, save the waveform on which you are performing the measurement as a .wfm file

Once you have gathered this information, you can contact technical support by phone or through e-mail. If using e-mail, be sure to enter in the subject line "TDSUSB2 Problem," and attach the .set and .wfm files.



Tip To include screen shots from the oscilloscope menu bar, select File> Export Setup> Image tab or File > Save > Screen Capture. Save the screen shot in the default directory or you can choose a directory of your choice. If you want the screen shots in color, select Edit> Copy setup> Images tab or select File > Save > Screen Capture and select Options to get the Screen Capture Save Option dialog box. Select the Color, Full Screen and the Normal option buttons. Select Copy. Copy the picture to any Paint editor software.

You can then attach the file to your email (depending on the capabilities of your email editor).

Getting Started

Introduction and Product Description

The TDSUSB2 Universal Serial Bus Measurements is a package that runs on the supported instruments. The solution consists of a Java-based application and a comprehensive test fixture. You can use the application software with the compliance test fixture to take the following measurements:

- Signal Quality
- Inrush
- Droop
- Drop (supported by the test fixture only)
- Receiver Sensitivity
- Impedance Measurement using Time Domain Reflectometry (TDR), supported by the application only with the test fixture
- Chirp measurements
- Packet Parameter
- Resume
- Reset from Suspend
- Reset from High Speed
- Suspend

The application performs tests that measure the test signals for USB2.0 compliance, displays eye diagrams and plots, displays the results as a summary or as details, and generates reports in different formats.

Compatibility

For information on oscilloscope compatibility, refer to the **Optional Applications Software on Windows-Based Oscilloscopes Installation Manual*, Tektronix part number 071-1888-XX. The manual is also available as a PDF file. The dynamic range of the probes used for Low Speed and Full Speed testing should be at least ± 8 volts. For High Speed testing, the dynamic range should be ± 2 volts.

***For a current list of compatible instruments, see the Software and Drivers category in the Tektronix Web site**

Requirements and Restrictions

You must install Java Run-Time Environment V1.4.2_02 on the supported oscilloscope.

The application uses the Math1 channel for Low Speed and Full Speed mode of operation. You will lose any information that you have stored in the Math1 channel.

You cannot restore the oscilloscope settings if you select File> Exit from the application.

Accessories

The application includes the following standard accessories:

- Optional Application Software on Windows-Based Instruments CD-ROM
- Optional Application Software on Windows-Based Instruments Installation Manual
- TDSUSB2 Universal Serial Bus Measurements Package Reference
- TDSUSBF USB2.0 Compliance Test Fixture Instructions
- TDSUSBF USB2.0 Compliance Test Fixture

Optional Accessories

- DG2040 Data Generator (for receiver sensitivity)
- AWG610 Arbitrary Waveform Generator
- P6248 Differential probes

- P6245, P6243, TAP1500 Single-ended active probes
- TCP202/TCP0030 Current probes
- TDS8000 Instrument with 80E04 Time Domain Reflectometry sampling module
- Deskew Fixture: for supported instrument-Probe Calibration and Deskew Fixture, Tektronix part number (067-0405-xx)

Installation

Setting up the Instrument to Take Measurements

To set up the oscilloscope, follow these steps:

1. You must power on the oscilloscope for twenty minutes before you can start to take measurements.
2. You must run the compensation signal path on the oscilloscope.
3. You must make sure that the default factory setup is recalled before you start using the application in the oscilloscope. To do so, push the recall default setup button on the front-panel of the oscilloscope to recall the default factory settings.
4. You should always use calibrated probes and degauss the current probes.

Recommended Instruments and Probes

For information on recommended instruments and probes, refer to the *Optional Application Software on Windows-Based Oscilloscopes Installation Manual*.

Installing the Application

Refer to the *Optional Applications Software on Windows-Based Instruments Installation Manual* for the following information:

- Installing an application
- Applying a new label
- Enabling an application
- Downloading updates from the Tektronix Web site

You can find a PDF (portable document format) file of this document in the Documents directory on the *Optional Applications Software on Windows-Based Instruments CD-ROM*. The CD booklet only contains information on installing the application from the CD and on how to apply a new label.

Deskewing

Deskewing the Probes and Channels

To ensure accurate measurements, you must deskew the probes before you take measurements from your unit under test. The deskew process is where the oscilloscope adjusts the relative delay between the signals to accurately time correlate the displayed waveforms.

The application includes an automated deskew utility that you can use to deskew any pair of oscilloscope channels.

***Note 1:** It is recommended that you use the deskew fixture specified in the accessories section to perform deskew. The deskew source can be the built-in probe compensation signal in the oscilloscope or an external signal source.*

***Note 2:** The oscilloscope has a deskew range of 50 ns.*

Deskewing Probes and Channels on the supported Instruments

To deskew probes and channels on the supported instruments, follow these steps:

1. Connect the probes to Ch1 and Ch2 on the oscilloscope.
2. Connect the probe compensation signal to the deskew fixture. You can use the probe compensation signal from the oscilloscope as the source for the deskew fixture.
3. Follow the on-screen prompts for the deskew operation with an external source.

The following figure shows signals before performing the deskew procedure with a single edge:



Figure 1: Signals before deskew

4. To start the application from a supported oscilloscope, select File> Run Application> USB2.0 Test Package or Analyze>USB2.0 Test Package from the menu bar of the oscilloscope.
5. Select Utilities> Deskew.
6. Set the channel Source in the From area to Ch1. The Source waveform is the reference point to which the remaining channels are deskewed.
7. Set the channel Source in the To area to Ch2, to deskew the channel.
8. Select the Reference Level for Ch1 and set the reference value. The reference level is the percentage level of the waveform from which to take the edges to deskew.
9. Select the Reference Level in the To area for Ch2 and set the reference value.
10. Select the Hysteresis in the From area for Ch1. Hysteresis helps to ignore the noise level in the waveform.

11. Select the Hysteresis in the To area for Ch2 and set the hysteresis value.
12. Select the Slope, Rise or Fall, on which to perform the deskew operation.
13. Select the number of edges used for deskew.
14. To start the deskew utility, select Utilities> Perform Deskew and confirm the operation.
15. Without changing the From: Ch1 channel, deskew the remaining channels.

The following figure shows the results after performing the deskew operation with a single edge. The reference level is set to 50% for Ch1 and Ch2, the hysteresis is set to 5%, the number of edges is set to 1, and the slope is set to the rising edge.

Note: The probe compensation signals vary from 0.8 to 1 volt (for all supported TDS instruments) and from 0.35 to 1 volt (for all supported DPO instruments) rather than swinging from 0 to 1 volt in a traditional oscilloscope. Set the Reference level and the Hysteresis level appropriately so that the Ref level is at the middle of the swing on the signal.



Figure 2: Signals after deskew

To perform the deskew operation with an external source, follow these steps:

1. Connect the probes to Ch1 and Ch2 on the oscilloscope.
2. Connect an external source to the deskew fixture.
3. Follow the instructions of the Probe Calibration and Deskew fixture (Tektronix part number: 067-0405-xx) to make the connections.
4. Set up the oscilloscope as follows:
 - Use the Horizontal Scale knob to set the oscilloscope to an acquisition rate so that there are two or more samples on the deskew edge.
 - Use the Vertical Scale and Position knobs to adjust the signals to fill the display without missing any part of the signals.
 - Set the Record Length so that there are more samples for the edges in the acquisition. It is recommended that you set the record length to 25000 points.
5. To start the application from a supported oscilloscope, select File> Run Application> USB2.0 Test Package or Analyze> USB2.0 Test Package from the menu bar of the oscilloscope.
6. Select Utilities> Deskew.
7. Set the channel Source in the From area to Ch1. The remaining channels are deskewed to the Source waveform, which is the reference point.
8. Set the channel Source in the To area to Ch2, the channel to be deskewed.
9. Select the Reference Level for Ch1. The reference level is the percentage level of the waveform from which to take the edges to deskew.
10. Select the Reference Level in the To area for Ch2 and set the reference value.
11. Select the Hysteresis in the From area for Ch1. Hysteresis helps to ignore the noise level in the waveform.
12. Select the Hysteresis in the To area for Ch2 and set the hysteresis value.
13. Select the Slope, Rise or Fall, on which to perform the deskew operation.
14. Select the number of edges used for deskew.
15. To start the deskew utility, select Utilities> Perform Deskew and confirm the operation.
16. Without changing the From: Ch1 channel, deskew the remaining channels.
17. The setup is an acquisition of a square signal at 100 KHz, with the Record length set to 25000 points to achieve the sample resolution of 1.6 ns.

The following figure shows an example of a deskew setup:

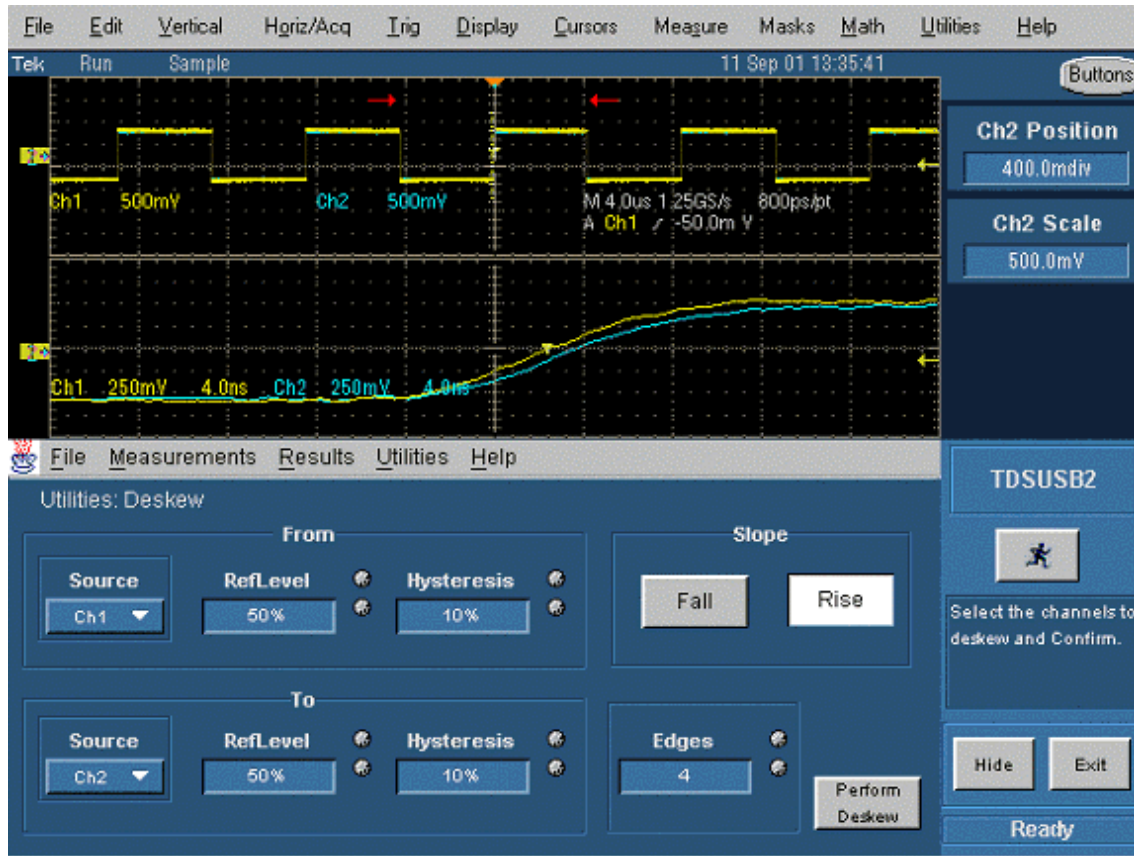

Figure 3: Example of deskew setup

18. Set the Reference levels for Ch1 and Ch2 in the application to 50%, the hysteresis to 10%, the number of edges to 4, and the type to rising edge. The following figure shows the display after performing the deskew for the multiple edge:

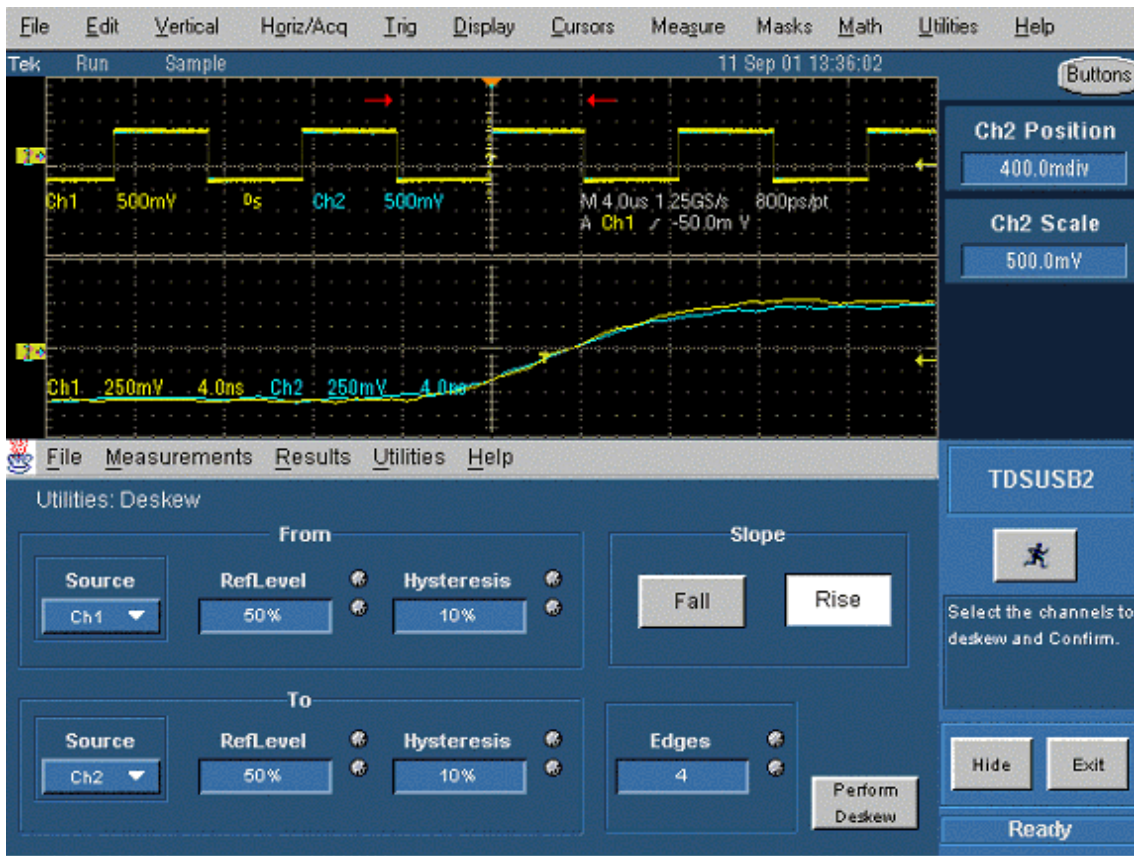

Figure 4: Signals after deskew for multiple edges

19. The zoomed section of the waveform available on the lower part of the screen shows the results of the deskew operation clearly. You will see that after performing the deskew operation the skew is automatically removed.

Operating Basics

About Basic Operations

This section contains information on the following topics and tasks:

- [Application interface](#)
- [Using basic oscilloscope functions](#)
- [Setting up the software](#)
- [Selecting a measurement](#)
- [How to Save and Recall setups](#)
- [Exiting the application](#)

Application Interface

The application uses a Windows interface. You should refer to your oscilloscope user manual for the operating details of other controls, such as the front-panel buttons.

Application Interface Menu Controls

Table 1. Application menu description

Item	Description
Menu bar	Located at the top of the application display and contains application menus
Tab	Labeled group of options containing similar items
Area	Visual frame that encloses a set of related options
Option button	Button that defines a particular command or task
List box	Box that contains a list of items from which you can select one item
Box	Box that you can use to type in text, or to enter a value with the Keypad or a Multipurpose knob
Check Boxes	Square box that you can use to select or clear preferences
Scroll bar	Vertical or horizontal bar at the side or bottom of a display area that can be used for moving around in that area
Browse	Displays a window where you can look through a list of directories and files
Command button	Button that initiates an immediate action
Keypad	Keypad appears when you select the box; select and use it to enter a value
MP/GPKnob	A line that appears between the knob and the box when the MP or GP knob is selected; turn the knob and select a value

Basic Instrument Functions

Using Basic Oscilloscope Functions

You can use the Help menu to access information about the oscilloscope. You can also use other oscilloscope functions and easily return to the application.

The TDSUSB2 application includes Online Help about the application menus and controls.

To display the Online Help, follow these steps:

1. Choose Help from the TDSUSB2 menu bar.
2. Use the Contents, Table of contents, or Index tabs to navigate through the help.
3. The touch screen mode of operation is enabled by default. You can disable this by using the Touch Screen OFF button on the oscilloscope front panel.

Minimizing and Maximizing the Application

To minimize the application, select File> Minimize. When you minimize the oscilloscope, the application is continually displayed.

To maximize the application, select the TDSUSB2 icon in the Windows taskbar.

Application Directories and File Names

The application uses the directories for several functions, such as save and recall setup files, and uses the extensions appended to the file names to identify the file type.

The following table lists default directory names for the supported instruments:

Table 2. Application Directories and File names

Directory	Used for
C:\TekApplications\tdsusb2	Home location
C:\TekApplications\tdsusb2\report	Report files
C:\TekApplications\tdsusb2\setup	Setup files
C:\TekApplications\tdsusb2\tsvfilegenerator	Default directory for the tsv file generated by the file generator and for other csv files.
C:\TekApplications\tdsusb2\datagen	Digital signal generator pattern files for use in Receiver Sensitivity Test
C:\TekApplications\tdsusb2\images	Images of the eye diagram and waveform plots
C:\TekApplications\tdsusb2\temp	Temporary files used in the application

File Name Extensions

Table 3. Description of File names

Extensions	Description
.csv	Input file is in the .csv (comma separated variable) format and is used to generate a .tsv (tab separated variable) file. An exported waveform that may be used as a source to generate a tsv format file
.ini	Application setup file
.set	Instrument setup file with the same name, saved and recalled with .ini and .set file name extension
.tsv	Input file in a Tab Separated Variable format

Returning to the Application

When you access oscilloscope functions, the oscilloscope fills the display. You can access oscilloscope functions in the following ways:

1. Select the Hide button in the application display.
2. Select the Menu bar or the Toolbar mode on the oscilloscope and access the menus.
3. To return to the application, click the App button on the menu bar of the oscilloscope or click on Analyze > Restore Application to restore the application.

Exiting the Application

To exit the application, select the Exit button or File> Exit or select the Exit button from the control panel.

When you exit the application, you can keep the oscilloscope setup currently in use or restore the oscilloscope setup that was present before you started the application.

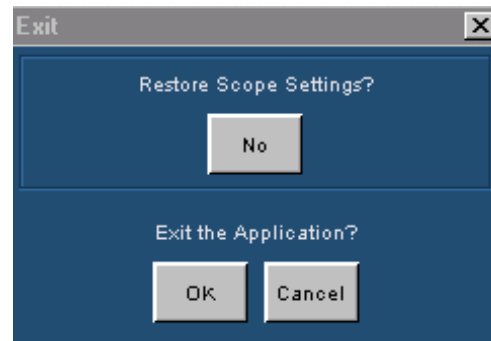

Figure 5: Exiting the application

Setting up the Software to take Measurements

Description of the Test Fixture

The TDSUSBF USB2.0 Compliance Test Fixture is a break-out board that enables you to test live USB2.0 signals, exchanged between the device and the host. For more information on the compliance test fixture, refer to the *TDSUSBF USB2.0 Compliance Test Fixture Instructions* shipped with the test fixture.

The compliance test fixture consists of the following sections:

- SQ Test Section
- Receiver Sensitivity Test
- Impedance Measurement Test (TDR)
- Disconnect Detect Test
- Adjacent Trigger and Droop Test
- Host SQ
- Inrush Test
- Downstream Signal Quality

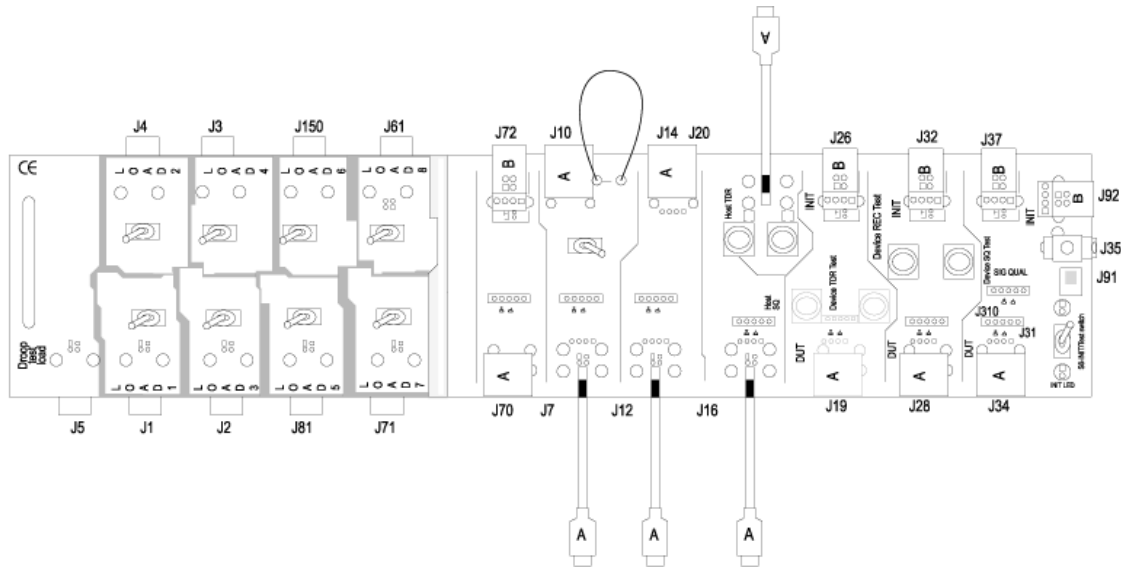

Figure 6: Test fixture

Setting Up the Device Details

You can enter a unique identifier (ID) and description for the unit under test (device). The identifier and the description appear in the generated reports for the tests performed on the unit under test. You can either type in the text directly in the boxes for these fields, or use the keypad or a keyboard. You can also choose to generate automatic IDs for the unit or enter a prefix using the keypad.

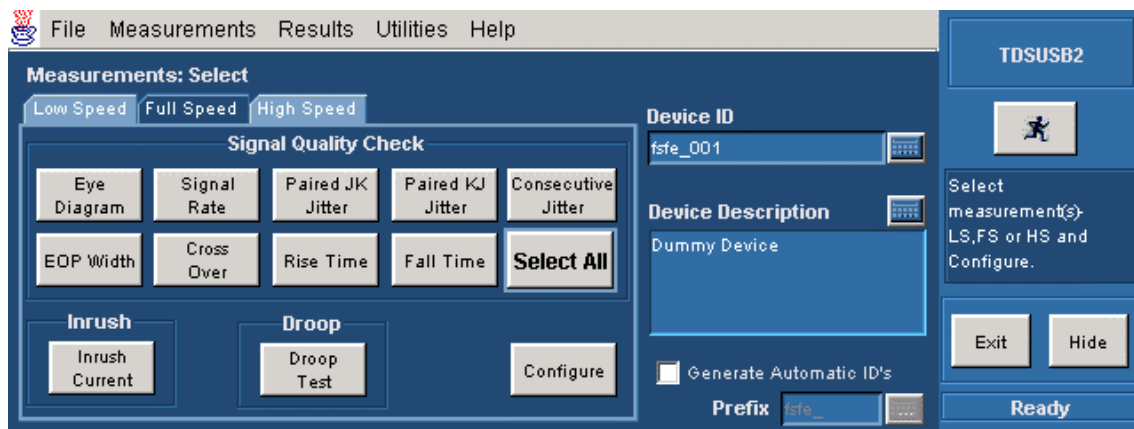

Figure 7: Setting up the device details

Note: If you check the Generate Automatic ID, the Device ID field is disabled and the Prefix field is enabled. The report for Inrush Measurement displays details of the Signal Setup with the device description.

Setting up the Software

You can set up the application to take one or more measurements at the same time. In addition, you can view the results as a summary, details, an eye diagram, and a waveform plot for Signal Quality checks. You can also generate the reports in one of the three formats: Tektronix Specific, Plug-Fest and CSV formats.

The application runs on the oscilloscope. It is recommended that you connect the keyboard and the mouse to use the application effectively.

Setting Preferences

The Preferences menu consists of two tabs: General and Advanced. To access the Preferences menu, select File> Preferences.

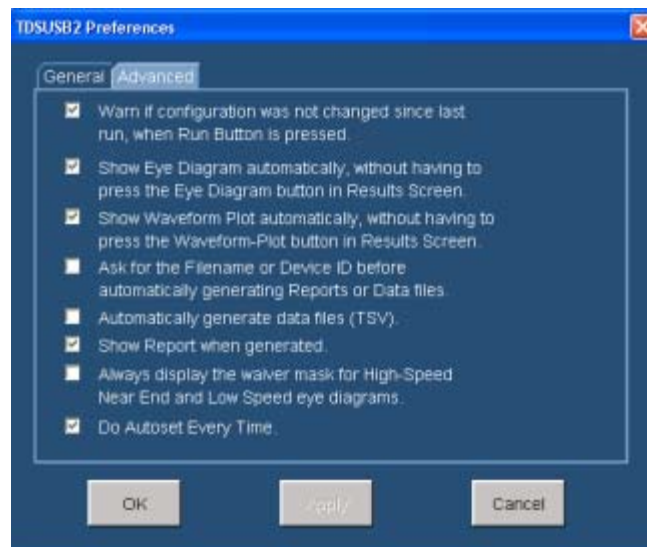

Figure 8: Setting general preferences

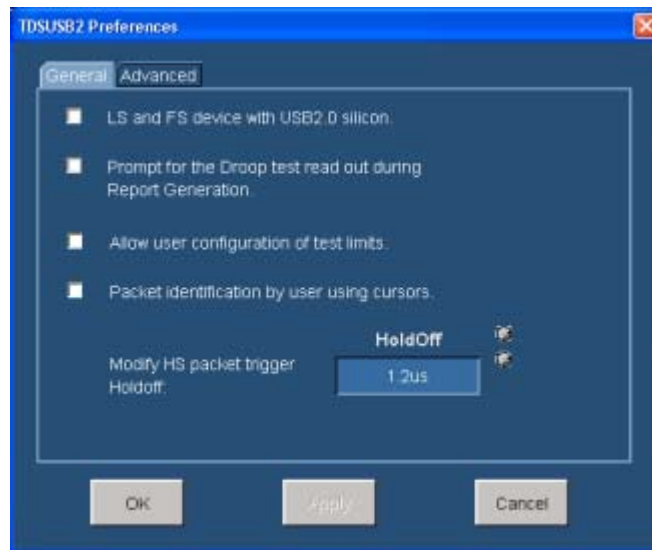

Figure 9: Setting advanced preferences

In the General tab, you can select the following options:

- Set a warning to indicate that the configuration options were not changed since the last time you ran the application. If you set this option, the application prompts you to configure the measurements before acquiring data
- Automatically display the Eye Diagram without having to select the Eye Diagram button in the Results screen
- Automatically display the Waveform Plot without having to select the Waveform Plot in the Results screen
- Prompt for a File name or Device ID before automatically generating reports or data files
- Automatically generate .tsv files
- Display the generated report
- Always display the waiver mask for High-Speed Near End and Low Speed eye diagrams
- Do Autoset Every Time.

Note: Autoset will happen only for Full-Speed/High Speed SQC measurements.

In the Advanced tab, you can select the following options:

- Test a Low or Full Speed device with USB2.0 silicon
- Prompt during report generation for the Droop test readout. When you enable this option, the application disables report generation in the Automatic mode
- Configure the test limits. The result: PASS or FAIL is determined by the limits you have defined
- Place the vertical cursors between the start and end of the single USB2.0 packet. This is used when more than one USB2.0 packet is displayed on the oscilloscope for Signal Quality measurements
- Set the trigger holdoff value to capture the USB2.0 high-speed test packet

Note: If you enable the Configure Test Limits options, the Results Summary and Report Generation in Plug-Fest format is disabled.

Table of Measurements and Options

Low Speed and Full Speed Measurements

Table 4. Low and Full Speed measurements

Area	Option	Description
Signal Quality Check	Eye Diagram	Checks whether the USB signal is aligned with its corresponding eye diagram
Signal Quality Check	Signal Rate	Measures the inverse of the average bit-time that gives the transmission rate of the USB signal
Signal Quality Check	Paired JK Jitter	Measures the jitter time for paired (JK next to KJ) differential data transition
Signal Quality Check	Paired KJ Jitter	Measures the jitter time for paired (KJ next to JK) differential data transition
Signal Quality Check	Consecutive Jitter	Measures the jitter at every consecutive data bit calculated using the signal rate
Signal Quality Check	EOP Width	Measures the width of the end-of-packet of a USB signal
Signal Quality Check	Cross-Over voltage	Measures the voltage at which the D+ voltage crosses the D- voltage
Signal Quality Check	Rise Time	Measures the elapsed time from when a rising edge crosses the low reference voltage level and then the high reference voltage level
Signal Quality Check	Fall Time	Measures the elapsed time from when a falling edge crosses the high reference voltage level and then the low reference voltage level
Inrush Current Check	Inrush Current	Measures the amount of electrical charge drawn by a device as soon as it is connected to a USB network
Droop Test	Droop Test	Measures the difference in the VBUS voltage when the load switch is open to the lowest value of the voltage and the load switch

High Speed Measurements

Table 5. Low and Full Speed measurements

Area	Option	Description
Signal Quality Check	Eye Diagram	Checks whether the USB signal is aligned with its corresponding eye diagram
Signal Quality Check	Signal Rate	Measures the inverse of the average bit-time that gives the transmission rate of the Test_Packet
Signal Quality Check	Monotonic Property	Detects when the Signal is Monotonic if and only if data $[i+1] \geq$ data $[i]$ in case of consistently increasing (rising slope), never decreasing data $[i+1] \leq$ data $[i]$ when consistently decreasing (falling slope) and never increasing in value where i ranges from 0 to n
Signal Quality Check	EOP Width	Measures the width of the end-of-packet pattern of a Test_Packet
Signal Quality Check	Rise Time	Measures the elapsed time from when a rising edge crosses the low reference voltage level and then the high reference voltage level
Signal Quality Check	Fall Time	Measures the elapsed time from when a falling edge crosses the high reference voltage level and then the low reference voltage level
Inrush Current Check	Inrush Current	Measures the amount of electrical charge drawn by a device as soon as it is connected to a USB network
Droop Test	Droop Test	Measures the difference in the VBUS voltage when the load switch is open to the lowest value of the voltage and the load switch

Table 5. Low and Full Speed measurements (cont.)

Area	Option	Description
Receiver Sensitivity Test	Receiver Sensitivity	Is an indicator of Receiver Sensitivity. A High Speed capable device must indicate 'packet (Data) not received' (squelch) when the input of the receiver falls below 100 mV differential amplitude. Similarly the device must not indicate squelch if the differential amplitude is greater than 150 mV
Chirp Test	Chirp	Checks a part of handshake that occurs during Reset Protocol for high-speed capable hubs and devices. In this handshake, the hub/host and the device are required to detect chirp J and K of a specified minimum duration and amplitude
Suspend Test	Suspend	Measures the time between the end of the last Start of Frame (SOF) and the rising edge transition to the Full Speed J state. The acceptable range should be between 3 ms to 3.125 ms. This is applicable if you have selected a Host, Device, or a Hub-Upstream device
Resume Test	Resume	Resumes the High-speed operation in a device or a hub, which is indicated by the presence of High-speed SOF packets (with 400 mV nominal amplitude) following the K state driven by the host controller. For the Host this is the time between the falling edge of D+ to the First SOF. This should not exceed 3.0 ms
Rest from High-Speed Test	Reset	Measures the time between the beginning of the last SOF and before the reset and the beginning of Chirp-K. This is between 3.1 ms and 6 ms. This test will be applicable for Device and HUB upstream
Reset from Suspend	Reset from Suspend	Measures the time between the falling edge of D+ signal and the start of Device chirp-K. This is between 2.5 us and 3 ms. This test is applicable for Device and HUB upstream
Packet Parameter	Packet Parameter	Measures the parameter of the packet such as Sync Bits, EOP, and Inter-Packet Gap depending on the selected measurement

Selecting a Measurement

To take a measurement, select Measurement from the Measurements menu, which is also the default opening screen in the application. To access the Select option in the Measurement menu, select Measurements> Select.

There are three categories of measurements: Low Speed, Full Speed, and High Speed measurements. The measurements for Low, Full and High Speed signals are Signal Quality Checks, Inrush Current Check, and Droop Test. The additional measurements for High Speed tests are Receiver Sensitivity, Monotonic Property, and Chirp Test, Packet Parameter, Suspend, Resume, Reset from Suspend, and Reset from High Speed.

You need to select the measurements for a particular signal speed of the unit under test. After selecting the tests, you must configure the application based on Signal Source, Tier, Test Point, and Signal Direction.

You can test the units for the following:

- Devices for Upstream Signal Quality Check

- Hubs and Hosts for Downstream Signal Quality Check
- Ports of a Hub for Droop Test
- Devices for Inrush Current

Signal Quality Check

The application performs Signal Quality tests that include the following tests:

Table 6. Signal Quality checks

Area	Option	Description
Signal Quality Check	Eye Diagram	Checks whether the USB signal is aligned with its corresponding eye diagram
Signal Quality Check	Signal Rate	Measures the inverse of the average bit-time that gives the transmission rate of the USB signal
Signal Quality Check	Paired JK Jitter	Measures the jitter time for paired (JK next to KJ) differential data transition
Signal Quality Check	Paired KJ Jitter	Measures the jitter time for paired (KJ next to JK) differential data transition
Signal Quality Check	Consecutive Jitter	Measures the jitter at every consecutive data bit calculated using the signal rate
Signal Quality Check	EOP Width	Measures the width of the end-of-packet of a USB signal
Signal Quality Check	Cross-Over voltage	Measures the voltage at which the D+ voltage crosses the D- voltage
Signal Quality Check	Rise Time	Measures the elapsed time from when a rising edge crosses the low reference voltage level and then the high reference voltage level
Signal Quality Check	Fall Time	Measures the elapsed time from when a falling edge crosses the high reference voltage level and then the low reference voltage level
Signal Quality Check	Monotonic Property (For High Speed only)	Measures the Monotonic Signal if the data [i] < data [i-1] where data[i] is the record point in the acquired waveform. This is in the case of consistently increasing (rising Slope) only. If the data [i] > data [i-1] in case of consistently decreasing) falling Slope) and never increasing in value where i ranges from 0 to n, the signal I is said to be monotonic

Note: The USB2.0 specifications recommend that you should test the signal quality for upstream and downstream traffic. In upstream testing, the application captures the signals transmitted from the device to the host. In downstream testing, the application captures the signals transmitted from the host to the device.

Downstream testing is performed on ports of a hub. When testing a hub, you need to connect the USB2.0 unit to Tier 6 to ensure the worst case. Each hub level is referred to as a Tier. The hub under test is connected to the Tier 5, so that you can test the hub on the Tier 6.

Inrush Current Check

The application can perform an Inrush current check to verify that the unit under test does not draw current higher than that specified in the USB2.0 specifications when connected to a USB2.0 system. If the measured current drawn is higher than a specified value, the other USB2.0 devices connected to the bus may not be able to function properly.

When a unit is connected, there is a sharp intake of current followed by a comparatively less steep decay. Small humps or perturbations are noticed in the current trace, depending on when the unit resets.

The TDSUSB2 application automatically sets up the oscilloscope. The application gives a direct readout of Charge (μC) and Capacitance (μF) values. The application displays the details of the results after comparing the test results with the USB2.0 specifications.

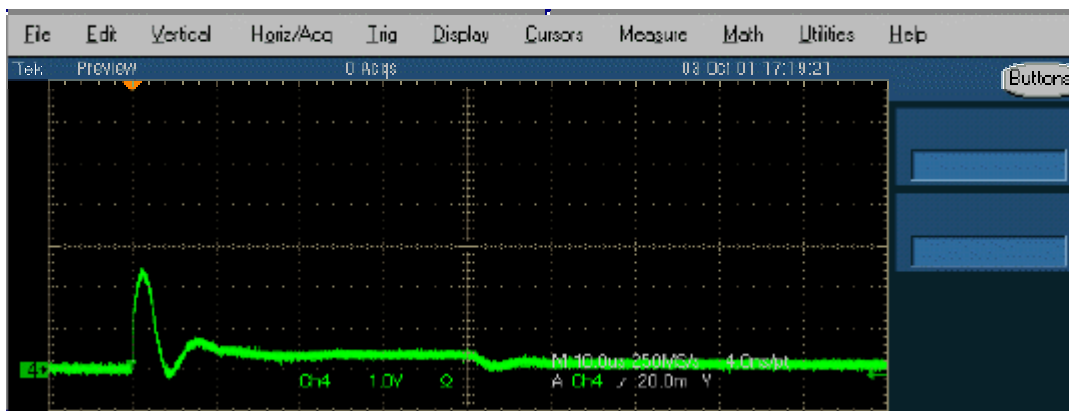

Figure 10: Results of the Inrush current check

Droop Measurement

The Droop voltage is the difference in the V_{BUS} voltage when you apply a no load condition and a 100 mA load to the port under test (all other ports are fully loaded).

The Droop test evaluates the worst case droop by alternately applying a droop load and no load to the port under test while all other ports are supplying the maximum load possible. All the V_{BUS} measurements are relative to local ground.

The TDSUSB2 application automatically sets up the oscilloscope for the specified test configuration. When you start the application, it acquires the signal, and provides the V_{DROOP} measurement, and displays PASS or FAIL.

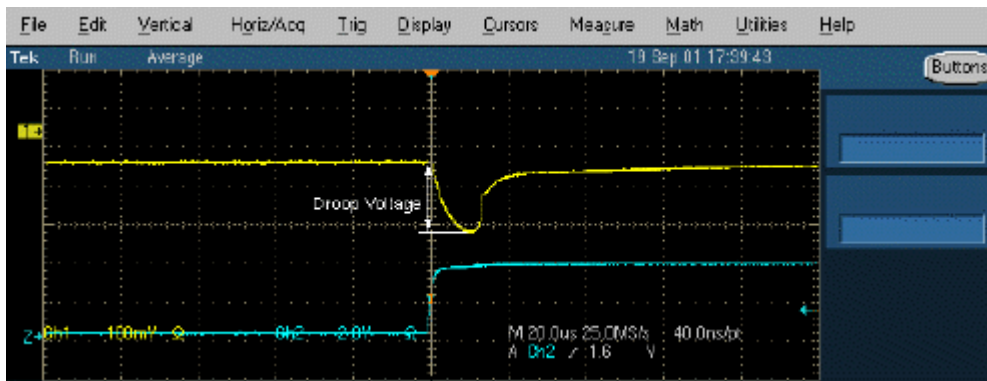

Figure 11: Results of the Droop measurement

Note: The TDSUSB2 application helps to report the Drop test. You can do this by enabling an option in the File > Preferences > Advanced menu. You can enter the multimeter reading for the Drop test in the TDSUSB2 application during report generation for a consolidated report.

Receiver Sensitivity Measurement

To improve the performance of the application in a noisy environment, the USB2.0 high-speed device should respond to IN tokens with NAKs when the signaling level is at or above the specified level.

The Receiver Sensitivity test requires a high-speed data simulator, such as the Tektronix DG2040 USB Data Generator or a DTG5000 series instrument, to transmit IN tokens of varying amplitude. The test requires the unit under test to be placed in the Test_SE0_NAK mode. The host is then replaced by the data simulator to continue to transmit IN tokens. The signaling amplitude is presented to the device under test at a level at or above 150 mV. At these levels, the unit under test must not be in the squelched mode, responding to IN packets with NAKs. The amplitude of the signals from data simulator varies less than 100 mV. The unit under test must be squelched and not respond to IN tokens with NAKs.

This tests the receiver capability of high-speed units (device) to respond to the particular data pattern generated by the USB2.0 data simulator. The unit under test responds to the data pattern level above the squelch level (>150 mV) and should not respond when the data pattern level is below the squelch level (<100 mV).

The TDSUSB2 application provides the procedural steps to perform this measurement. It also provides Digital signal generator pattern files. Pattern files for other Tektronix data simulators are available from www.tektronix.com.

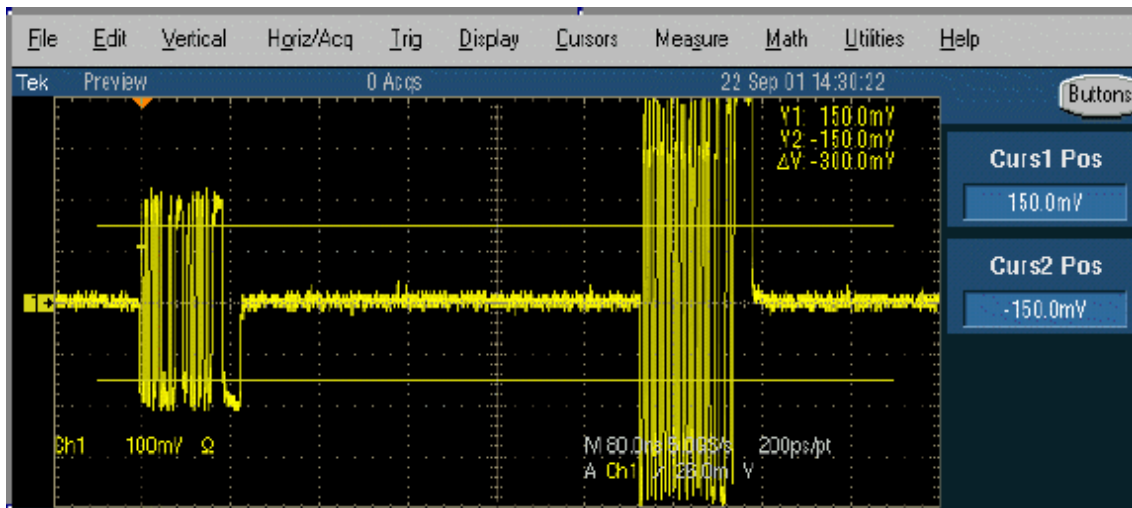

Figure 12: Results of the Receiver Sensitivity measurement

Chirp Measurement

To perform a Chirp test, connect the unit under test and the single-ended probes to acquire data. You can measure the Data for Chirp K amplitude, Chirp K duration, and Reset duration. You need to manually verify that there are three K-J pairs in less than 500 μ s.

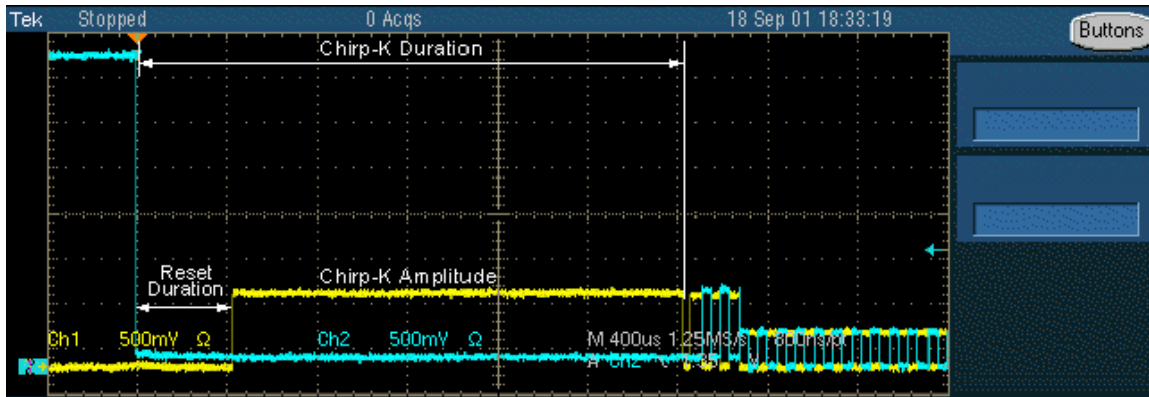

Figure 13: Results of the Chirp measurement

The TDSUSB2 application automates this process and automatically generates the results and reports for the results of Chirp-K duration, Chirp-K amplitude, and Reset duration.

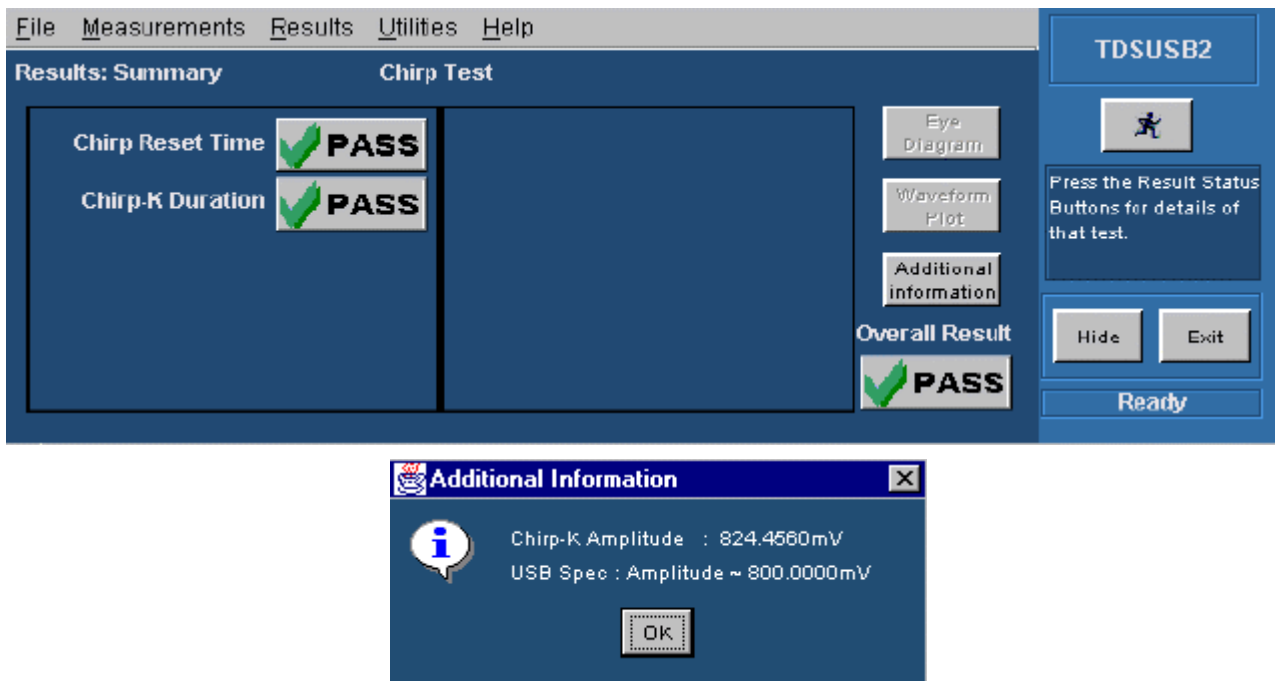
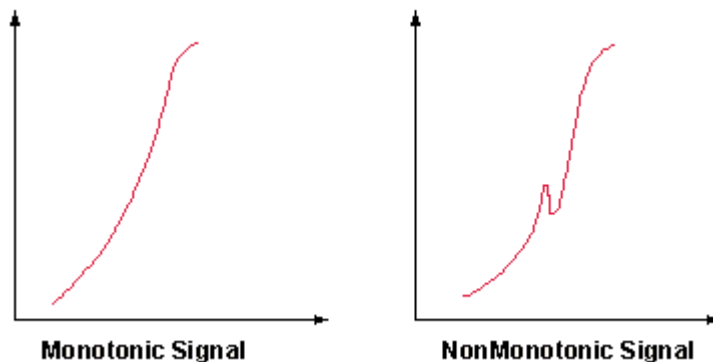

Figure 14: Summary results of the Chirp measurement

Monotonic Property

While performing a USB2.0 High Speed compliance test, you need to verify that the signal to be tested is monotonic.

The following graph shows the monotonic behavior of a USB2.0 high-speed signal with a rise time of 500 ps.



To verify the monotonic behavior of a signal, the oscilloscope must have a sample rate high enough to capture as many sample points as possible on a rising or falling edge. In addition, the oscilloscope should have enough bandwidth to ensure that the high frequency non-monotonic transition is not attenuated.

The application coupled with a high performance Tektronix oscilloscope automates the process and ensures repeatability of test results.

Configuring a Measurement

To access the Configure: Measurement, go to Measurements> Configure. The application also provides a Configure option with each measurement area to allow you to configure the selected measurements.

***Note:** If you select the Run button before configuring a measurement, the application displays the message ‘The selected measurements have not been configured. Do you want to continue?’ In this case, the application runs with the default settings. If you select the Run button before configuring the measurement and have enabled the File> Preferences> General option, the application displays the warning message ‘Warn if configuration was not changed since last run, when the run button is pressed.’*

Configure Limits

The application displays the maximum and minimum values for the selected tests. You can use the '>' sign on the keypad to configure limits for these options.

Table 7. Configure limits description

Option	Description
Set	Sets the values you enter
Default	Restore the default values
Cancel	Cancel all the changes you enter

Note: The application enables the Configure Limits values when you select the option File> Preferences> Advanced menu.

Configuring Signal Quality Measurements

To access the Measurement: Configure, go to Measurements> Configure. Be sure to select the relevant measurements before you configure them. There are two tabs for the Signal Quality Measurements: Configure and Source.

The Configure tab allows you to select and set the Tier, Signal Direction and the Test Point options. You must select the Tier (Tier 1 through 6), the direction of signal (Upstream or Downstream) and the Test Point (Near End or Far End) at which the unit will be tested.

For Low Speed and High Speed signals, you can set Test Point to Near End or Far End. For Full Speed signals, you can set the Test Point to Far End only.

For Rise Time, Fall Time, and Monotonic Property, you can configure the measurement levels.

The Source tab allows you to select the Source of the signal: a live signal or the signal from a file. For a live signal there are two options: Differential and Single-Ended. For Low Speed and Full Speed devices, you can test only single-ended signals (D+ and D-). For High Speed devices, it is recommended that you use a differential probe.

Configuring Inrush Current Measurements

To access the Measurements: Configure menu, go to the Measurements> Configure.

The Configure tab allows you to set the voltage value on V_{BUS} and the unit under test. The V_{BUS} can be entered manually or probed from a channel that is captured from the test fixture. Select this option from the Source tab of Inrush Configuration menu.

The Tier 1 is always used for testing. The unit under test can be any one of the following types:

- Hot Plug Attach
- Low Powered Configure
- Low Powered Resume
- High Powered Configure
- High Powered Unconfigure
- High Powered Resume

The Hot Plug Attach is the most common unit under test. The Source tab allows you to select the source of the signal: a live signal or the signal taken from a tsv file. If you choose to manually enter the V_{BUS} voltage, you cannot select the V_{BUS} voltage source.

Configuring Droop Measurements

Select the Droop measurement and configure it. To access the Configure: Measurements menu, go to Measurements> Configure.

The Configure tab allows you to select the Port (Port 1 through 7), Hub and Source of the signal. The source of the signal can be live or from a .tsv file. The hubs can either be Self-powered or Bus-powered.

Configuring Receiver Sensitivity Measurements

To configure receiver sensitivity measurements, follow these steps:

1. Select the High Speed measurement tab> More button> Receiver Sensitivity measurement.
2. To access the Configure Measurements menu, select Measurements> Configure.

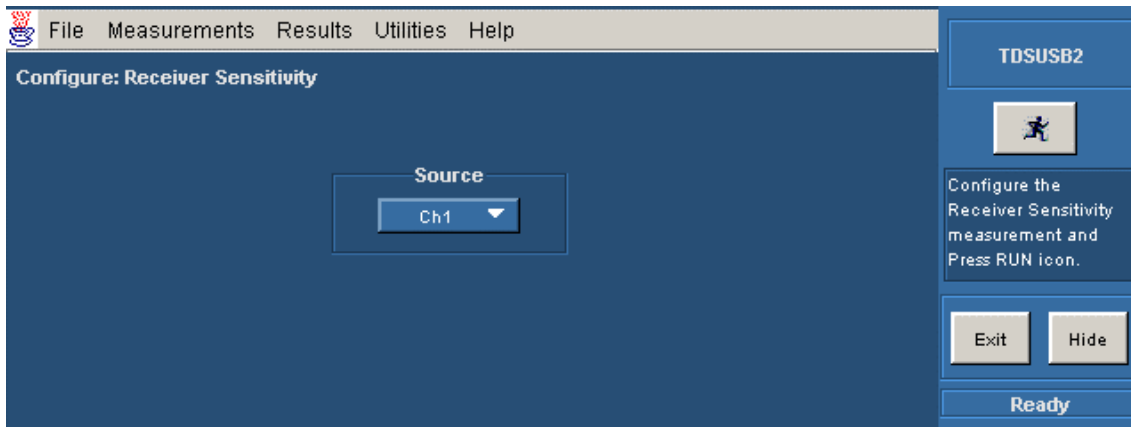

Figure 15: Configuring Receiver Sensitivity measurement

3. Select the Source from Ch1 to Ch4.
4. Select the Run button.
5. Select OK and follow the on-screen prompts to perform the tests.
6. To generate reports, select Utilities> Report Generator.

Configuring Chirp Measurement

To configure chirp measurements, follow these steps:

1. Select the High Speed measurement tab> More button> Chirp measurement.
2. To access the Configure Measurements menu, go to Measurements> Configure.
3. In the Configure tab, you can select the DUT (Host or Device) and perform selected tests associated with it.

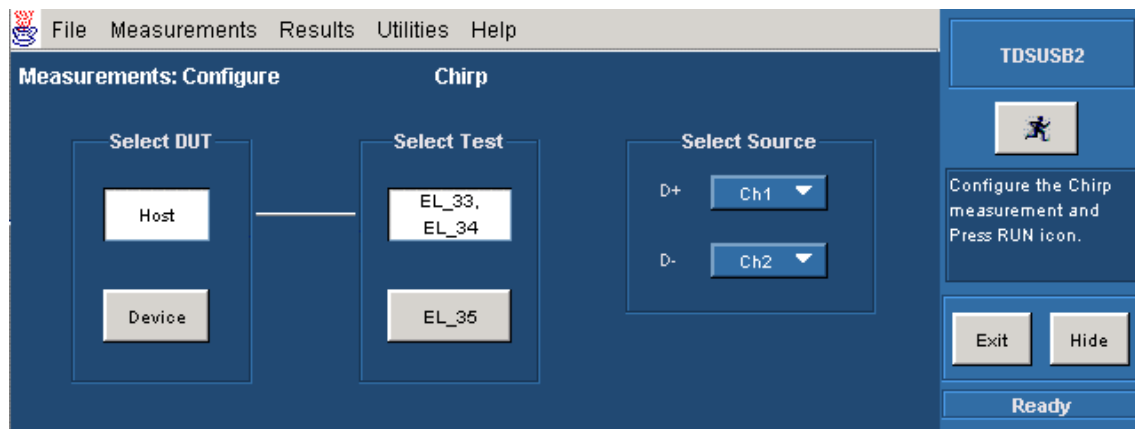

Figure 16: Configuring Chirp measurement for host

4. Select the Host option to display the different tests for the DUT. The available tests are:
 - EL_33, EL_34: You can perform two separate measurements on an acquired waveform
 - EL_35: You can perform a single measurement on an acquired waveform

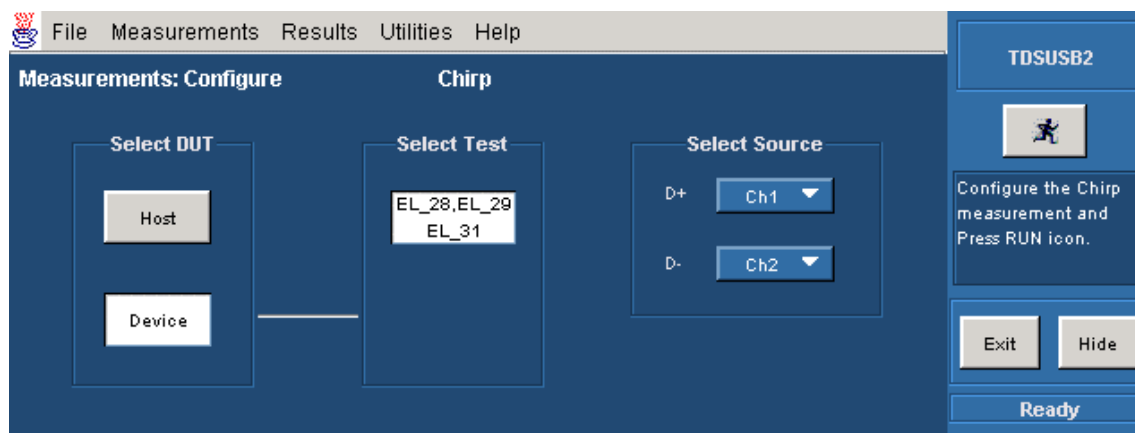

Figure 17: Configuring Chirp measurement for device

5. Select the Device option to display the different tests for the DUT. The available tests are:
 - EL_28, EL_29: You can perform two separate measurements on an acquired waveform
 - EL_31: You can perform a single measurement on an acquired waveform

6. Select the channel source in the D+ and D– fields. Use the drop down arrow in the D+, D– field to set the source. The available options are: Ch1- Ch4 and Ref1-Ref4.
7. Select the Run button.
8. To generate reports, select Utilities> Report Generator.

Configuring Reset from High Speed Measurement

To configure Reset from High Speed measurement, follow these steps:

1. Select the High Speed measurement tab> More button> Reset from High Speed measurement. This is the time between the beginning of the last SOF and before the reset and the beginning of Chirp-K. This test will be applicable for Device and HUB upstream.
2. To access the Configure Measurements menu, go to Measurements> Configure.

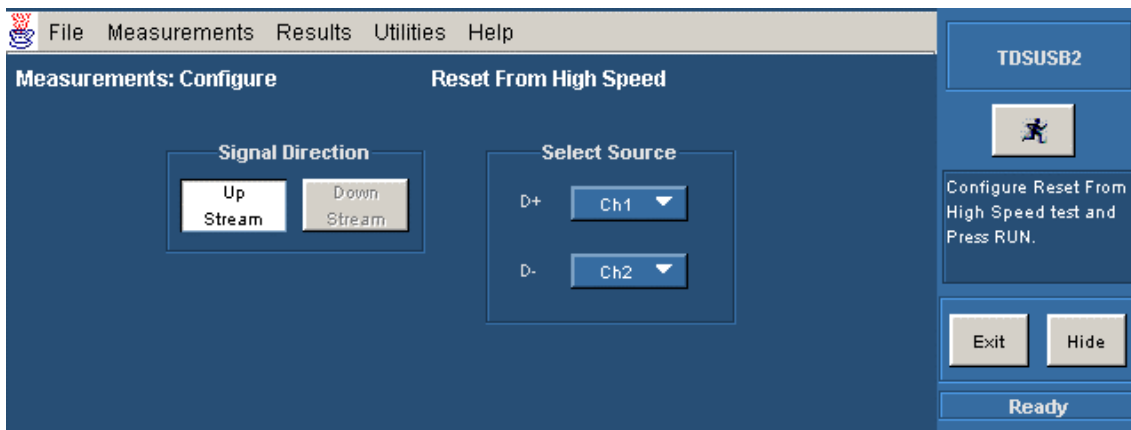

Figure 18: Configuring Reset from High Speed measurement

3. The Upstream signal direction is enabled by default. This is because you can measure Reset from High Speed only on an upstream signal. The Downstream option is disabled here.
4. Select the channel source in the D+ and D– fields. Use the drop down arrow in the D+, D– field to set the source. The available options are: Ch1- Ch4 and Ref1-Ref4.
5. Select the Run button.
6. To generate reports, select Utilities> Report Generator.

Configuring Resume Measurement

To configure Resume measurement, follow these steps:

1. Select the High Speed measurement tab> More button> Resume measurement. The device/HUB resumes the High-Speed operation, which is indicated by the presence of High-speed SOF packets (with 400 mV nominal amplitude) following the K state driven by the host controller. For the Host, this is the time between the falling edge of D+ to the First SOF. This should not exceed 3.0 ms.
2. To access the Configure Measurements menu, go to Measurements> Configure.

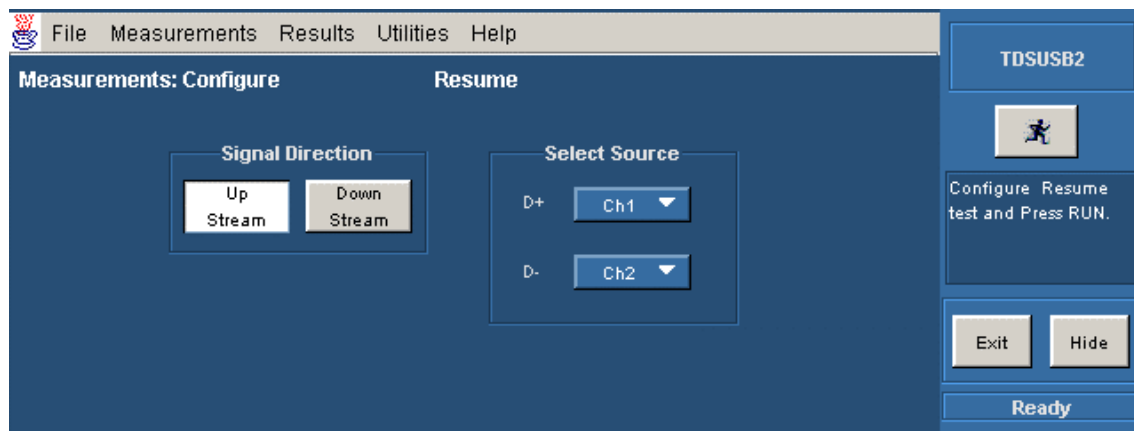

Figure 19: Configuring Resume measurement

3. Set the input Signal Direction to either Upstream or Downstream.
4. Select the channel source in the D+ and D- fields. Use the drop down arrow in the D+, D- field to set the source. The available options are: Ch1- Ch4 and Ref1-Ref4.
5. Select the Run button.
6. To generate reports, select Utilities> Report Generator.

Configuring Suspend Measurement

To configure Suspend measurement, follow these steps:

1. Select the High Speed measurement tab> More button> Suspend measurement. This measures the time between the end of the last SOF and the rising edge transition to the Full Speed J state. The acceptable range is between 3 ms to 3.125 ms.
2. To access the Configure Measurements menu, go to Measurements> Configure.

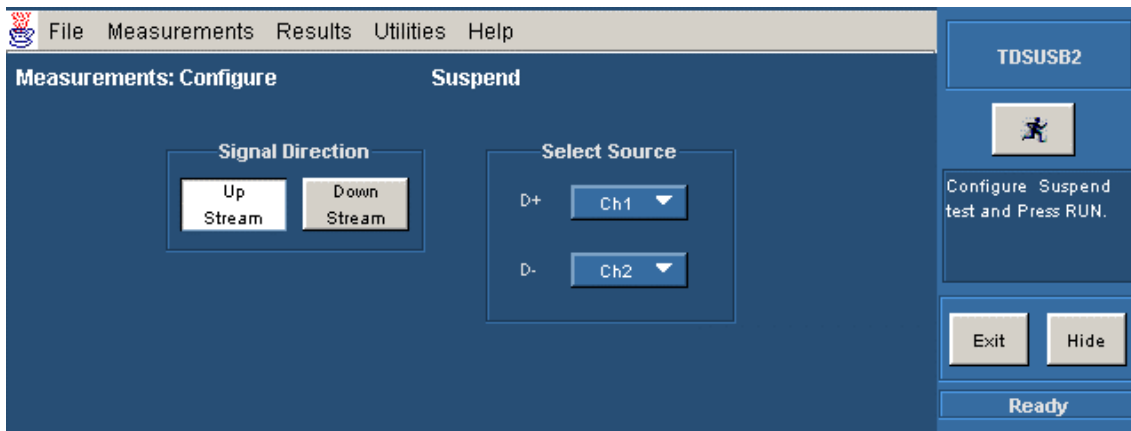

Figure 20: Configuring Suspend measurement

3. Set the input Signal Direction to either Upstream or Downstream.
4. Select the channel source in the D+ and D– fields. Use the drop down arrow in the D+, D– field to set the source. The available options are: Ch1- Ch4 and Ref1-Ref4.
5. Select the Run button.
6. To generate reports, select Utilities> Report Generator.

Configuring Reset from Suspend Measurement

To configure Reset from Suspend measurement, follow these steps:

1. Select the High Speed measurement tab> More button> Reset from Suspend measurement. This measures the time between the falling edge of D+ signal and the start of Device chirp-K. It is between 2.5 us and 3 ms. This test is applicable for Device and HUB upstream.
2. To access the Configure Measurements menu, go to Measurements> Configure.

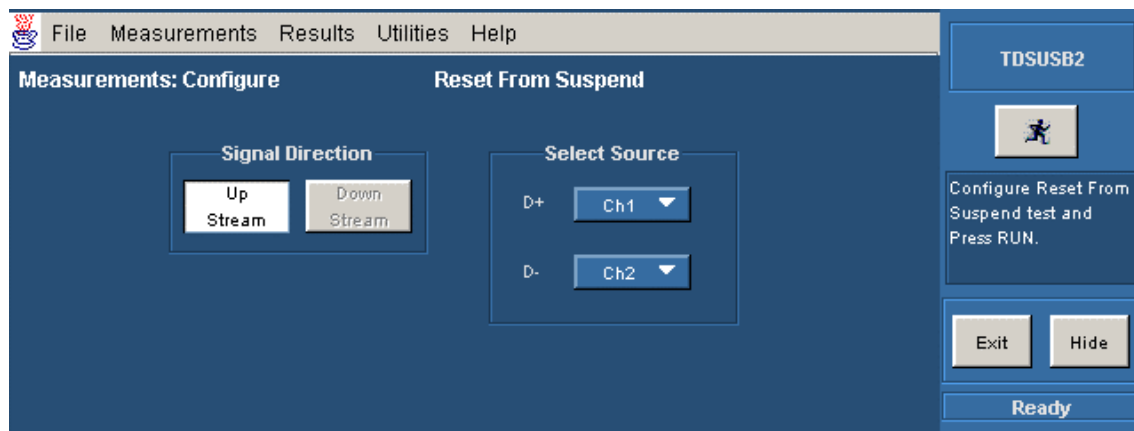

Figure 21: Configuring Reset from Suspend measurement

3. In the Configure tab, you can set the channel Source.
4. The signal direction is always set to Upstream. This is because you can measure Reset from Suspend only on an upstream signal. The Downstream option is disabled.
5. Select the channel source in the D+ and D– fields. Use the drop down arrow in the D+, D– field to set the source. The available options are: Ch1- Ch4 and Ref1-Ref4.
6. Select the Run button.
7. To generate reports, select Utilities> Report Generator.

Configuring Packet Parameter Measurement

To configure Packet Parameter measurement, follow these steps:

1. Select the High Speed measurement tab> More button> Packet Parameter measurement.
2. To access the Configure Measurements menu, go to Measurements> Configure.
3. In the Configure tab, you can select the DUT (Host or Device) and perform selected tests associated with it.

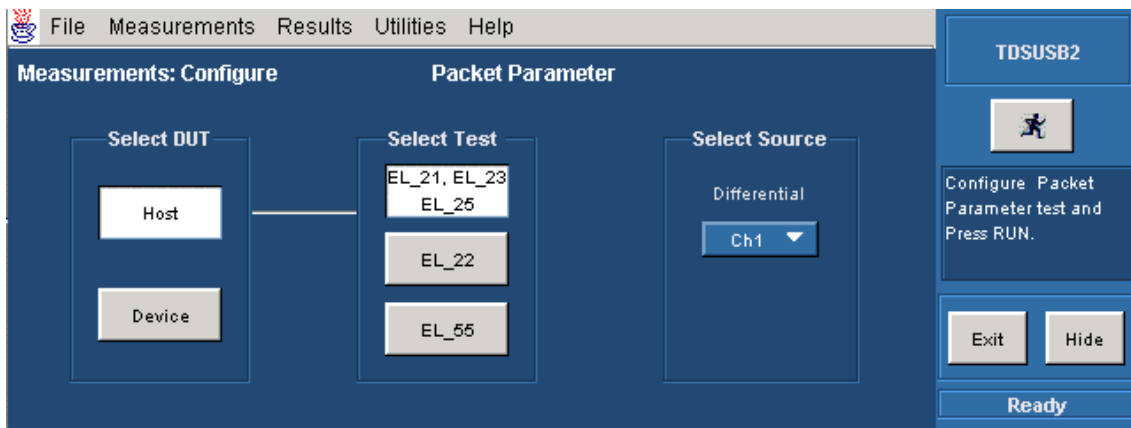

Figure 22: Configuring Packet Parameter measurement for host

4. Select the Host option to display the different tests for the DUT. The available tests are:
 - EL_21, EL_23, EL_25: You can perform three separate measurements on a single acquired waveform
 - EL_22: You can perform a single measurement on an acquired waveform
 - EL_55: You can perform a single measurement on an acquired waveform

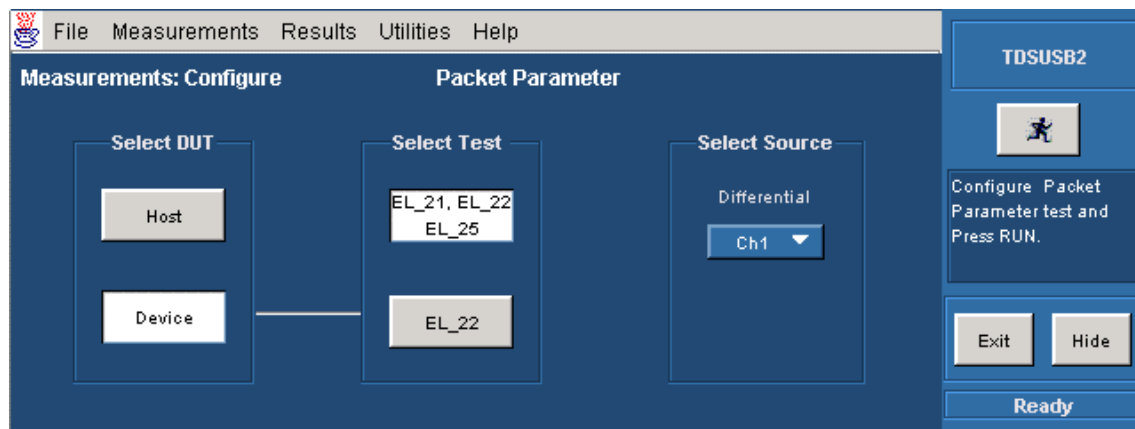

Figure 23: Configuring Packet Parameter measurement for device

5. Select the Device option to display the different tests for the DUT. The available tests are:
 - EL_21, EL_22, EL_25: You can perform three separate measurements on an acquired waveform
 - EL_22: You can perform a single measurement on an acquired waveform
6. Use the drop down arrow in the Differential field to set the channel source. The available options are: Ch1-Ch4, Ref1-Ref4.
7. Select the Run button.
8. To generate reports, select Utilities> Report Generator.

Packet Parameter Measurement

Packet parameter measurement is for high-speed Host controller and Device. There are several important packet characteristics for upstream and downstream signaling. The measurement calculates the SYNC field length, EOP length and inter packet gap. The acceptable range of EOP for all transmitted packets (except SOFs) must be between 7.5 and 8.5 bits. The packet parameter algorithm calculates the EOP depending on this range.

The acceptable range of inter packet gap is between 88 bits to 192 bits. The SYNC field for all transmitted packets is calculated by counting the bits to check for 32-bit SYNC field. The inter packet delay and SYNC status is calculated between the EOP indexes. The EOP width in time is calculated by dividing the EOP width by 480 Mbps.

Suspend Measurement

This test calculates the time between the end of last SOF and the rising edge transition to Full-speed J state for Host / Device / Hub- upstream. This time must be between 3 ms and 3.125 ms. To get the Suspend signal, hot-plug the unit under test (device) and measure the signaling with single-ended probes on both lines. The application analyzes data for the Suspend Time.

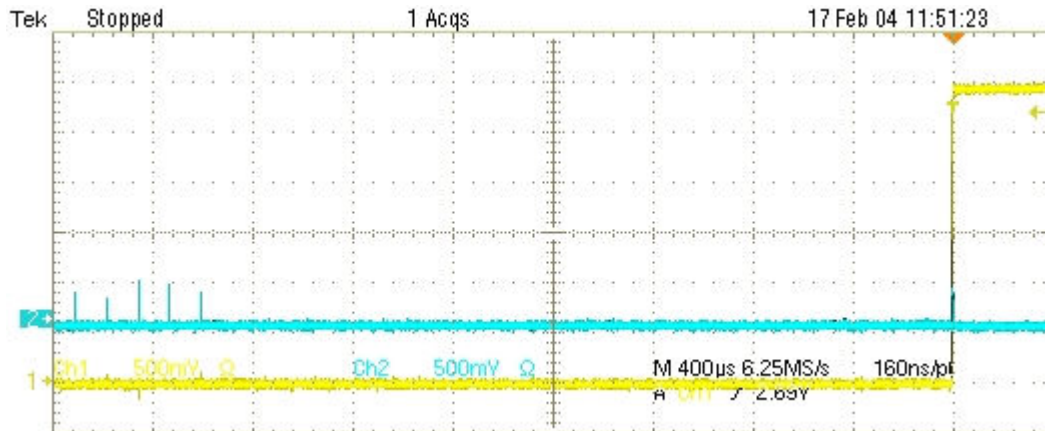

Resume Measurement

This test calculates the device/HUB resume High-speed operation, indicated by High-speed SOF packets (with 400 mV nominal amplitude) following the K state driven by the host controller. For the Host, this is the time between the falling edge of D+ and the First SOF. This should not exceed 3.0 ms. To get the Suspend signal, hot-plug the unit under test (device) and measure the signaling with single-ended probes on both lines. The application analyzes data for the following:

- Resume Time
- Amplitude

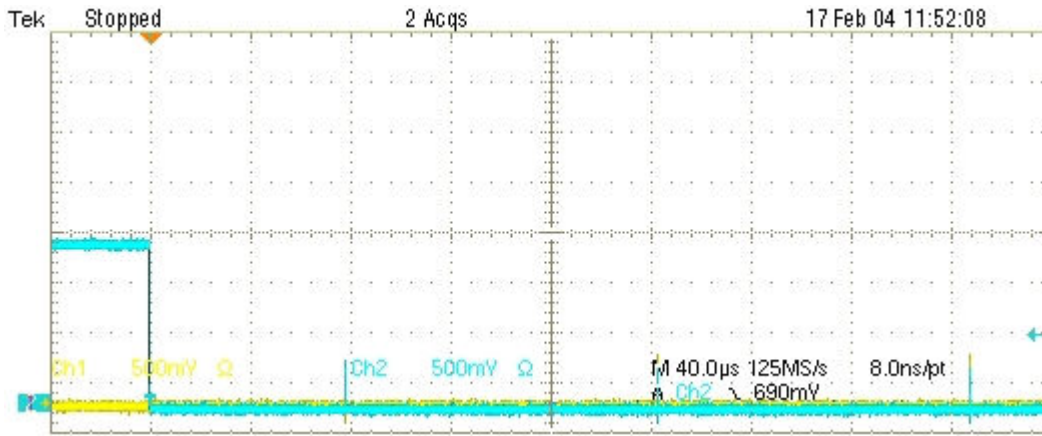

Reset from Suspend Measurement

This test calculates the time between the falling edge of D+ signal and the start of Device chirp-K for the Device/HUB upstream. This must be between 2.5 us and 3 ms. To get the Reset from Suspend Measurement signal, hot-plug the unit under test (device), and measure the signaling with single-ended probes on both lines. The application analyzes data for the Reset From Suspend Time.

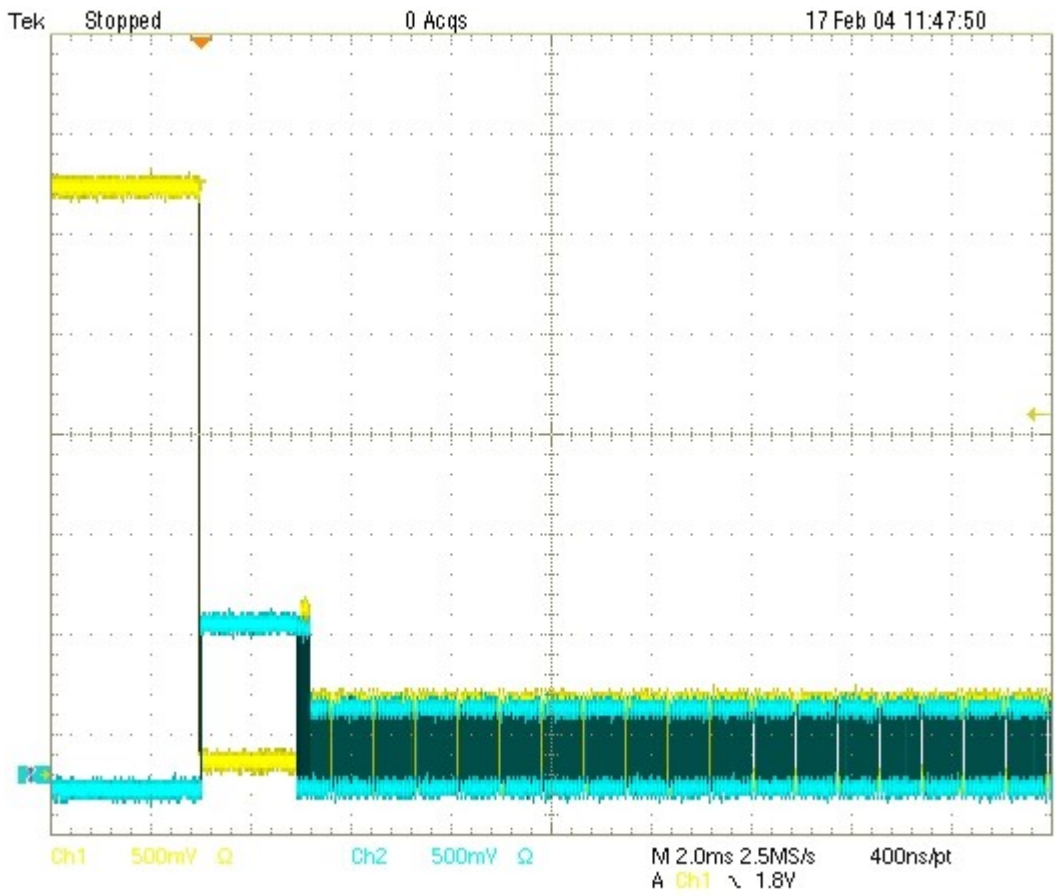

Reset from High Speed Measurement

This test calculates the time between the beginning of the last SOF and before the reset and the beginning of Chirp-K for Device and HUB upstream. This must be between 3.1 ms and 6 ms. To get the Reset from High-Speed Measurement signal, hot-plug the unit under test (device) and measure the signaling with single-ended probes on both lines. The application analyzes data for Reset From High Speed Time.

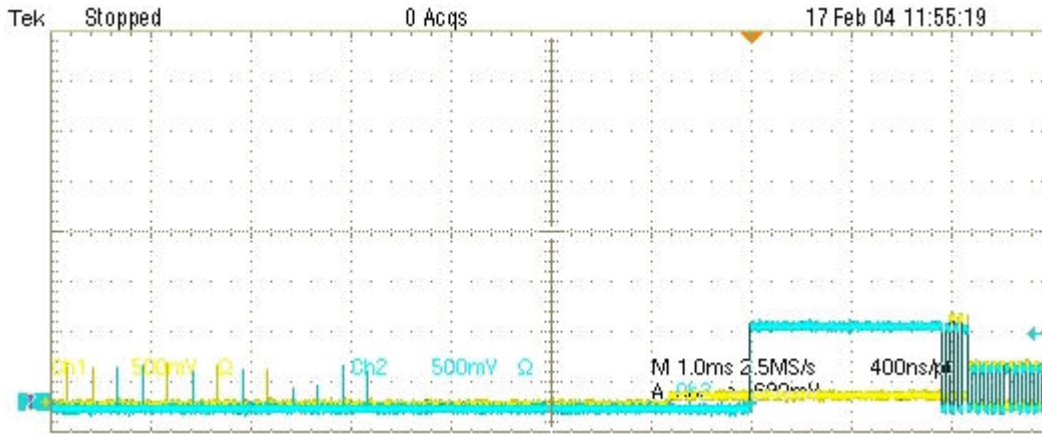

Taking Measurements

Acquiring Data

The application automatically sets the oscilloscope settings for the selected measurements. To acquire data from the oscilloscope, follow these steps:

1. Select the  command button to run the application.
2. The application displays the message “Please press OK when correct waveform is acquired” for live signals.

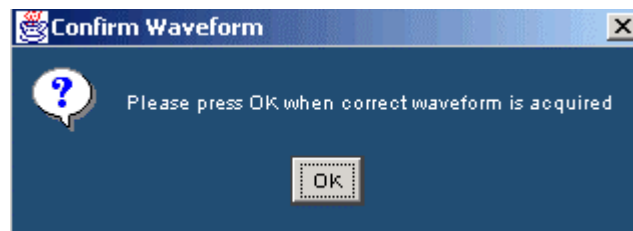

Figure 24: Confirm waveform screen

3. If you select the Cursor Mode, the application displays the message “Place the Cursors at the start and end position of the USB packet.” Press OK when done.

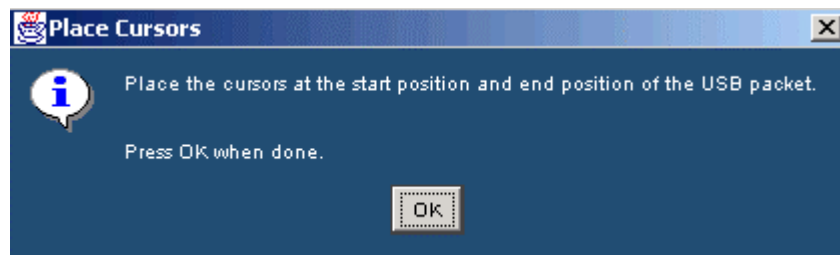

Figure 25: Place cursors screen

4. If you select the Inrush measurement, the application displays the message in the following figure:

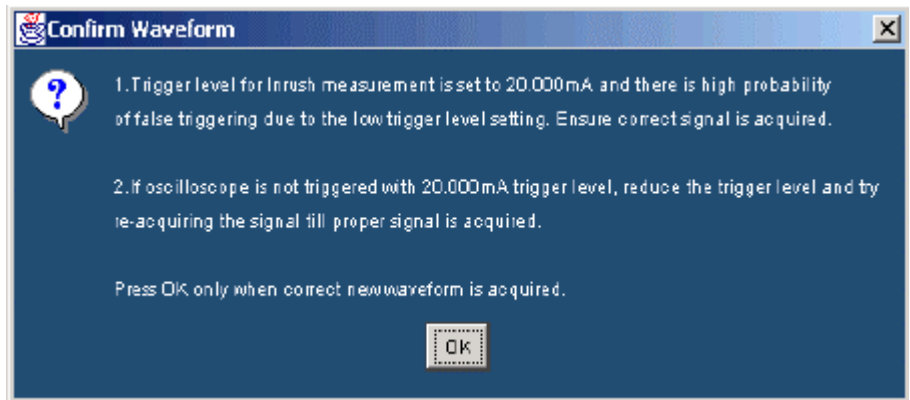

Figure 26: Confirm waveform for Inrush measurement

5. If you select the Droop measurement, the application displays the message in the following figure:

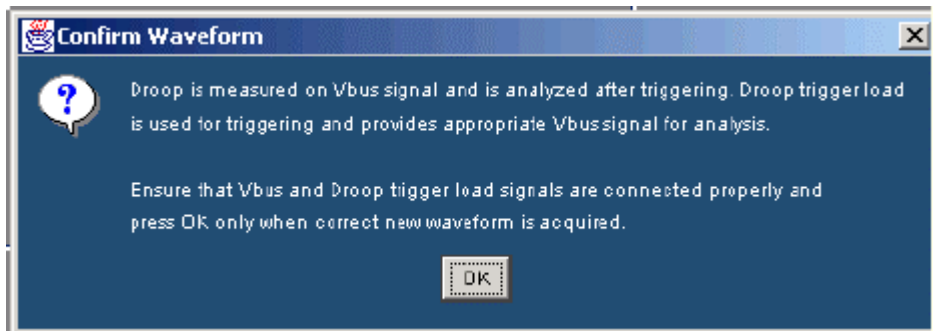

Figure 27: Confirm waveform for Droop measurement

6. If you select the Packet Parameter measurement, the application displays the message in the following figure:

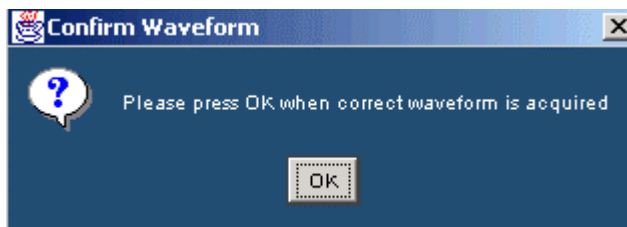



Figure 28: Confirm waveform screen

7. The application automatically displays the result after acquiring the data.
8. The application automatically displays the eye diagram and the waveform plot for the acquired signals. This is possible only if you enable this option in the Preferences > General.

Note: You can modify the automatic oscilloscope settings if there is no valid waveform on the oscilloscope screen. To do so, select the  command button to run the application and select OK to complete the process.

 **Tip** You may need to adjust the inrush setups, as inrush currents have a wide variety of durations and peak currents. Use the vertical division settings between 100 mA/division to 5 A/division and time bases between 500 ns/div and 20 μ s/division. If you set a time base higher than 20 μ s/division, adjust the instrument's record length to have minimum acquisition duration of 20 μ s.

Control Menu Options

Table 8. Control options

Option/button	Description
Run icon	Runs the application
Hide button	Hides the application and displays the oscilloscope application on the entire screen
Exit button	Exits the application

Viewing Results

You can view the results in a summary form or in a detailed form. To access the Results: Summary, select Results> Summary. The application displays one of the following results.



A PASS indicates that the results of the measurements comply with the USB2.0 specifications.



A FAIL indicates that the measured values of the measurements are beyond the waiver limits and do not comply with the USB2.0 specifications.



A Conditional PASS indicates that the limits of the tests are within the USB2.0 waiver limits.

Note: The application displays PASS or FAIL based on the limits you set.

To access the Details: select Results> Details. Use the scroll bar to view the results that are not visible within the display window. The report contains statistical values for the following:

- Standard deviation (StdDev)
- Mean
- Peak-to-peak (Pk-Pk)
- Root mean square (RMS)
- Maximum (Max) and minimum (Min) values
- Population (the number of cycles used to calculate the statistics). The population used for signal rates is number of bits
- Status (PASS/FAIL/Conditional PASS) for the selected tests

You can also view the eye diagram and the waveform plot for signal quality check.

Eye Diagram

You can select the Eye Diagram option to view the eye diagram for the unit under test. The eye diagram has the Zoom and Cursor features that you can use to view the results. You can also use the Reset button to reset the default eye pattern.

The Eye Diagram menu contains the following options:

Zoom: You can select the zoom from the menu. Select the  icon to zoom into the area of interest. Define the area of interest using the mouse and selecting the zoom in area. The selected area is displayed in the entire upper half of the

oscilloscope. Select the  icon to zoom out. You can use the Zoom In and Zoom Out icons until the application reaches the maximum and the minimum zoom limits.

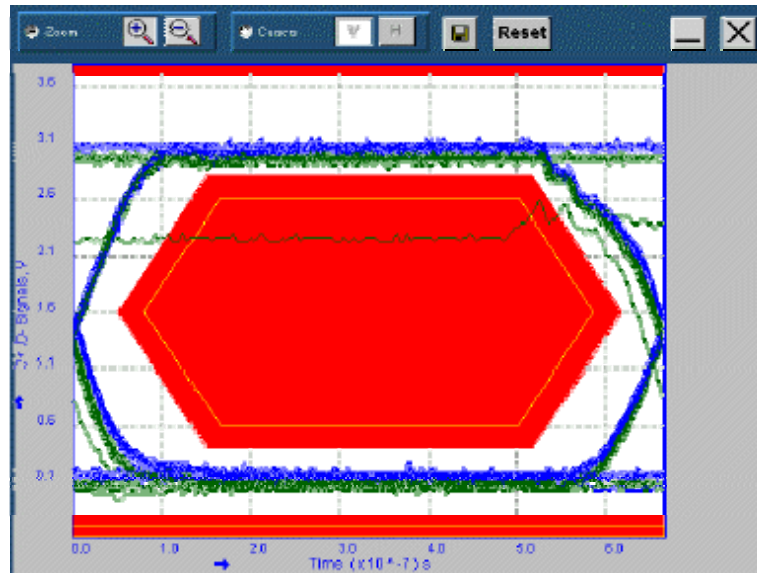

Figure 29: Eye diagram

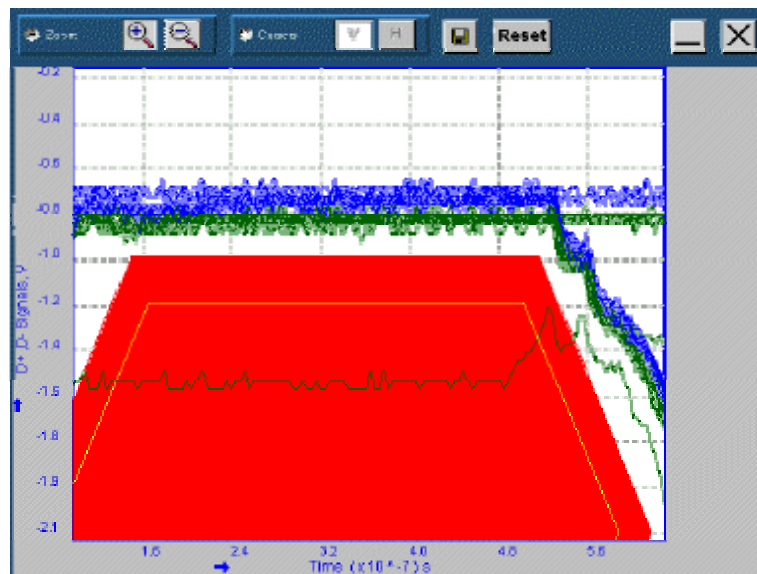

Figure 30: Eye diagram (zoomed)

Cursors: You can select the Cursors and the vertical cursors



appear. You can drag the cursors to change the positions, and read the time values on the X-axis.



Use the mouse to select the Horizontal cursor. You can drag the cursors to change the positions, and read the voltage values on the Y-axis.

Waveform Plot

You can select the Waveform Plot option to view the Waveform Plot for the unit under test. The Waveform Plot has a Zoom and the Cursor feature that you can use to view the results.

The Waveform Plot has features that enable you to zoom in and out on the waveform, use Vertical and Horizontal Cursors, Save the Plot, Reset the original plot, and select to display the signals.

To display any or all the signals for the waveform plots menu, you can use the following options:

Zoom: You can select the Zoom from the menu. Select the  icon to zoom into the area of interest. Define the area of interest using the mouse and selecting the zoom in area. The entire upper half of the oscilloscope displays the selected

area. Select the  icon to zoom out. You can use the Zoom In and Zoom Out icons until the application reaches the maximum and the minimum zoom limit.

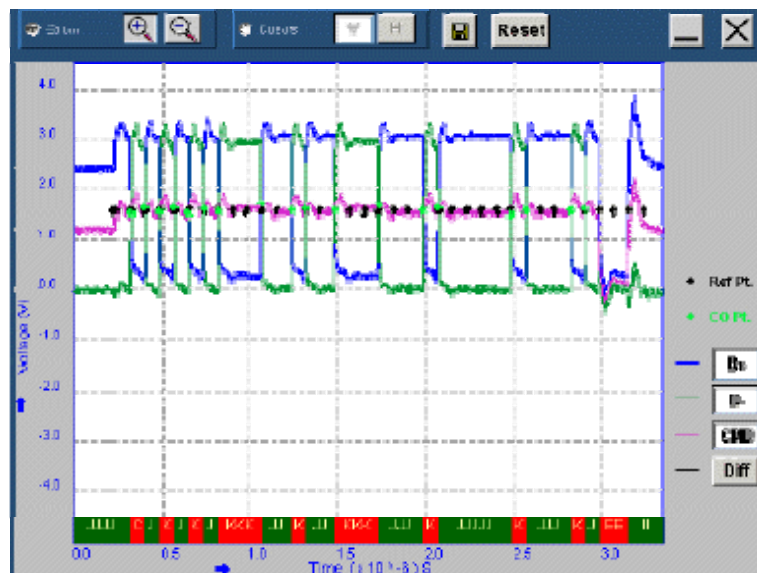

Figure 31: Using the zoom feature

Cursor: You can select the Cursors and the vertical cursors



appear. Drag the cursors to change the positions of the cursors, and read the time values on the X-axis.

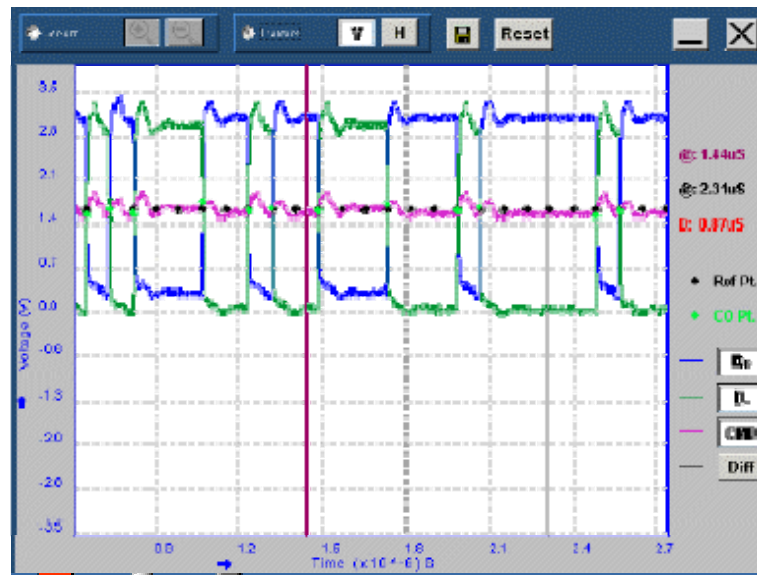



Figure 32: Using the cursors and viewing cursor readout







Select the Horizontal cursors . You can drag the horizontal cursors to change the positions, and read the voltage values on the Y-axis.

Note: The Zoom and Cursor options are mutually exclusive.

Save: You can use the Save button to save the zoomed in or zoomed out diagram as a .jpg file.

Reset: You can use the Reset button to restore the waveform plot to its original display.

For waveform plots, any or all the signals can be displayed using the following buttons:

- D+: Use this button  to turn on or turn off the display of the D+ signal
- D-: Use this button  to turn on or turn off the display of the D- signal
- CMD: Use this button  to turn on or turn off the display of the Common Mode voltage
- Diff: Use this button  to turn on or turn off the display of the Differential signal

You can use any combination of the Zoom or Cursors, D+, D-, CMD (Common Mode Voltage) and Diff buttons to view and save the waveform plot.

The annotations at the lower edge of the Waveform Plot classify the signal pulse into different bus states: J, K, E (EOP), I (IDLE) and Sync (C).

There are two Results menu options.

Summary: The application summarizes the results of the measurements. The results are classified as PASS, FAIL and Conditional PASS. Click on PASS, FAIL and Conditional PASS. The dialog box shows the Measured Mean, USB2.0 Specifications.

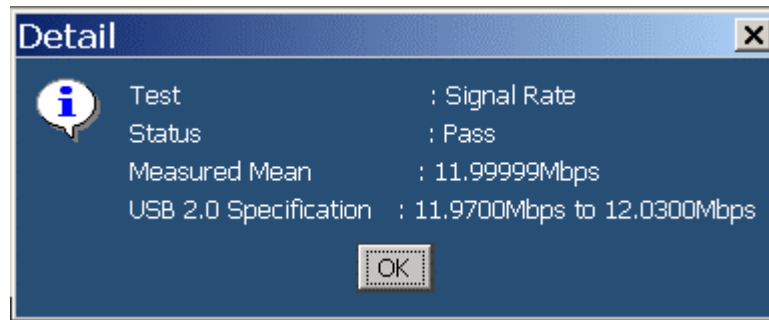

Figure 33: Details popup

Details: The application displays the results of the completed tests in a tabular form.

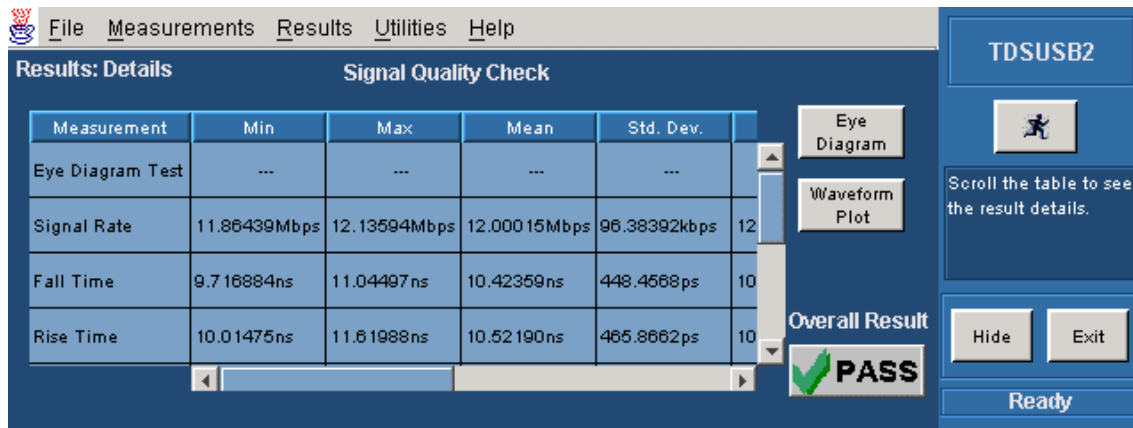

Figure 34: Results details

***Note:** The application displays the user column in the Results Details only if the User Configurable Limits are selected in File > Preferences > Advanced tab. The application disables the Results > Summary and Report generation in Plug-Fest Specific format when you enable Configure Test Limits.*

Report Generation

Generating Reports

To access the Report Generator menu, select Utilities> Report Generator. You can generate the USB IF report in any one of the three formats:

- Tektronix Specific is the default format used by the TDSUSB2 application
- Plug-Fest format is the format used by the USB-IF
- CSV format report is a user-defined report generated in a comma separated variable format

You can generate reports in one of the following modes:

- **Manual:** Select the report format, the directory name, and the file to which the report is saved. Select the Generate option to generate the report. Specify the file name for the report
- **Automatic:** The application generates reports automatically without user intervention as soon as the results are calculated. Select Generate Automatic Ids to enable this option while selecting measurements. The application uses the prefix that you enter to generate the file. If you select the Ask for the Filename/Device ID before automatically generating Reports/Data files check box in the File> Preferences> General tab, you can enter the Device ID/File Name before generating the report. If the File already exists, the application displays a message box to confirm whether to overwrite the existing report. If you select Yes, the application overwrites the report; if you select NO, you can enter a new Device ID/File Name or cancel the report generation. The reports are generated in the following path:

C:\TekApplications\tdsus2\report

The file name is prefix_001_reportformat.csv or efix_001_reportformat.htm.

The report contains the device ID, device description, date and result of the test. The report also contains the following statistical values:

- Maximum (Max) and Minimum (Min) values
- Mean
- Peak-to-peak (Pk-Pk)
- Standard deviation (StdDev)
- Root mean square (RMS)
- Population

- Status (PASS/FAIL/Conditional PASS) for the selected tests
- User- The application displays this value if you select the "Allow user configuration of test limits" in the Preferences menu and set the test limits before running the measurement

The report includes the eye diagram and the waveform plots for the Signal Quality Check. The display on the oscilloscope screen is embedded in the Inrush or the Droop report.

Note: Automatic Report generation is not available if you select the Drop Test readout option in File > Preferences > Advanced tab.

Viewing Reports

You can use an HTML viewer or a browser to view the Tektronix specific and Plug-Fest format reports. You can view the .csv (Comma Separated Variable) report in a text editor, spreadsheet, database, or a data analysis program for further analysis. You can edit the .csv file to suit your needs.

Note: All the reports contain the eye diagram and the waveform plot except for the reports generated in the .csv file format.

TSV File Generator

You can use the TSV File Generator Utility to convert a .csv (Comma Separated Variable) file to a .tsv (Tab Separated Variable) file. To access TSV File Generator, go to the main menu and select Utilities > TSV File Generator.

If the Input is a .csv file, then the application enables the CSV Waveform Source area. You can select the sources based on the Signal type. For a single-ended signal, specify the D+ and D- inputs.

You can specify the directory C:\TekApplications\tdsub2\tsvfilegenerator for the differential signal from where the .csv file is taken.

If the Input is a Live signal, you cannot access the CSV Waveform Source area. Select the Live or Ref as the source file to enable the Live Input option. You can enable the Convert option only if you take the measurements and display the results. The default directory for the .tsv files is C:\TekApplications\tdsub2\tsvfiles. You can also specify the location where the tsv file is to be generated.

TSV file format description

For Low Speed and Full Speed Signal Quality Check, the input TSV file is an $m \times 3$ matrix with m rows and three columns. The file has Time values and Voltage values for D+ and D- in the first, second and third columns respectively.

The input TSV file for High Speed Signal Quality Check is a $m \times 2$ matrix with m rows and two columns. The file has Time and Voltage values for Differential signals in the first and second columns.

The input TSV files for Inrush and Droop tests are an $m \times 2$ matrix with m rows and 2 columns. For Inrush tests, the file has Time and Current values in the first and second columns. For Droop test, the file has Time and Voltage values in the first and second columns.

CSV file format description

Low Speed and Full Speed single-ended signals for Signal Quality Check require two .csv files to generate the corresponding TSV file. The .csv files have two columns. One .csv file has time and voltage values for D+ signals, while the second column has the time and the current values for D- signals. Both files must have the same time values.

Differential signals require one .csv file with two columns, one column for time and another for voltage values.

If you select Differential for Inrush and Droop signals, the .csv file has two columns: one column for time values, and another for current and voltage values. You require only one .csv file for Inrush and Droop tests. This .csv file has two columns: one column for the Time Values and the other for Current (Inrush) and Voltage (Droop) values. You must use the Differential option for conversion.

Saving and Recalling Setups

How to Save and Recall a Setup

You can use the Save and Recall menus to save and recall the various configuration setups. To access the Save and Recall menus, go to the File menu in the menu bar and choose Save or Recall.

Note: Do not edit the .ini or the .set files, or the recall setup files generated by the application. This can cause instability to the application. If you try to edit the .ini of the .set files, you get an error message 'The saved file has been corrupted and cannot be recalled.'

Saving a Setup

You can save various configuration setups and recall them when needed. To save the application settings to a setup file, follow these steps:

1. Select File> Save
2. Select the Save button
3. Browse or enter a file name. The application appends an .ini extension to the name of setup files
4. Choose Save to save the setup or Cancel to cancel the action

Note: The application saves the oscilloscope setup to a .set file. The application .ini files and the oscilloscope .set files have the same file name.

Recalling a Saved Setup

To recall the application settings from a saved setup file, follow these steps:

1. Select File> Recall
2. Browse the directory C:\TekApplications\tdsusb2\setup to recall the .ini files or select the directory where you have saved the setup file
3. Select or enter an .ini file name
4. Choose Open to recall the setup or Cancel to cancel the operation

Note: The application recalls the oscilloscope setup from a .set file.

Recalling the Default Setup

To recall the application settings from the Default setup file, select File> Recall Default. The application recalls the default setup and displays the message 'Default setup recalled successfully.'



Figure 35: Recalling a default setup

Recently Saved Setup

The application stores the last four saved setups. If you need to modify any of them, follow these steps:

1. Select File> Recently Saved.
2. Select the setup from the list of recently saved setups that are displayed.

Note: When you select a file from the list of recently saved files menu, the file becomes the first element in the list of selections.

Recently Recalled Setup

The application stores the last four recalled setups. If you need to recall any of them, follow these steps:

1. Select File> Recently Recalled.
2. Select the setup from the list of setups displayed.

Note: When you select a file from the list of recently saved files popup menu, the file becomes the first element in the list of selections.

Tutorial

Introduction to the Tutorial

The tutorial teaches you how to set up the application by recalling a .tsv file, take measurements, and view the results. More operating information is available in the Operating Basics section. Before you begin the tutorial, you must do the following tasks:

- [Start the application](#)
- [Recall a .tsv file](#)

Starting the Application

To start the application, select File> Run Application> USB2.0 Test Package or App > USB2.0 Test Package or Analyze > USB2.0 Test Package.

Recalling a .tsv File

The application distribution includes the .tsv files used with this tutorial. The table below shows the types of signals that represent these waveforms.

Table 9. .tsv files

Tsv File name	Signal type
C:\TekApplications\tdsub2\tsvfiles\LS_SQC.tsv	Low Speed
C:\TekApplications\tdsub2\tsvfiles\FS_SQC.tsv	Full Speed
C:\TekApplications\tdsub2\tsvfiles\HS_sqc.tsv	High Speed
C:\TekApplications\tdsub2\tsvfiles\inrush.tsv	Low/Full/High Speed

Taking a Full Speed Signal Quality Measurement

This section discusses how to take a Full Speed Signal Quality measurement, view the results, and generate a report. To perform these tasks, the application must be installed and enabled on a supported oscilloscope. View [Installing the application](#) to install the application.

To take a Full Speed Signal Quality measurement, follow these steps:

1. To set the application to default values, select File> Recall Default. The application displays the message 'Default setup recalled successfully.' Select OK to view a screen image showing the default settings.
2. Select all the Signal Quality measurements in the Signal Quality Check area using Select All button.
3. Select the Configure tab or select Measurements> Configure. The Measurements: Configure default settings display.
4. Select the Measurements: Source. If the source is Live or Ref, configure the appropriate channels for D+, D- and Qualifier. You have to always select D+ first. If you select any one of the Live channels CH1-CH4 for D+ source, the remaining Live channels are selected from the D- and the Qualifier channel source. If you select any one of the Ref channels Ref1-Ref4 for D+ source, the remaining Ref channels are selected from the D-. There is no Qualifier channel source for the Ref signals.

If the source is from a file, use the browse button to look for the file.

Select the file C:\TekApplications\tdsusb2\tsvfiles\FS_SQC.tsv.

5. Select the  command button to run the application. The application displays the Eye Diagram and the Waveform Plot.

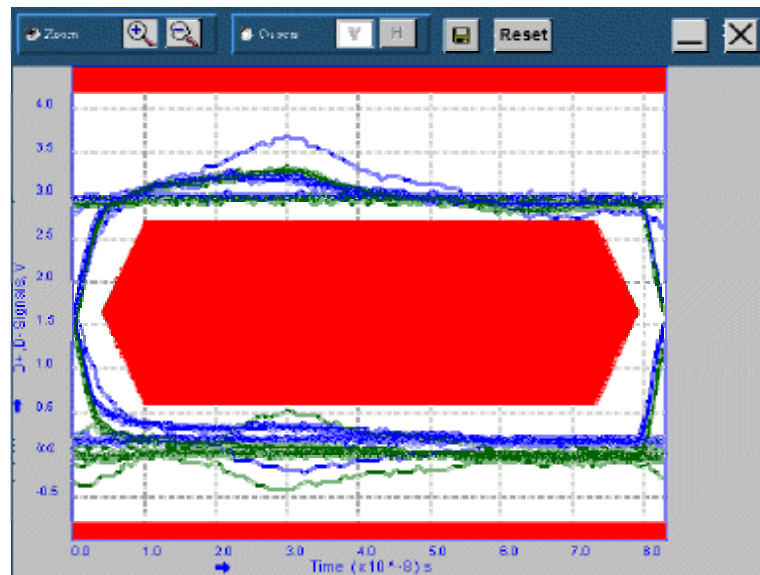

Figure 36: Eye diagram

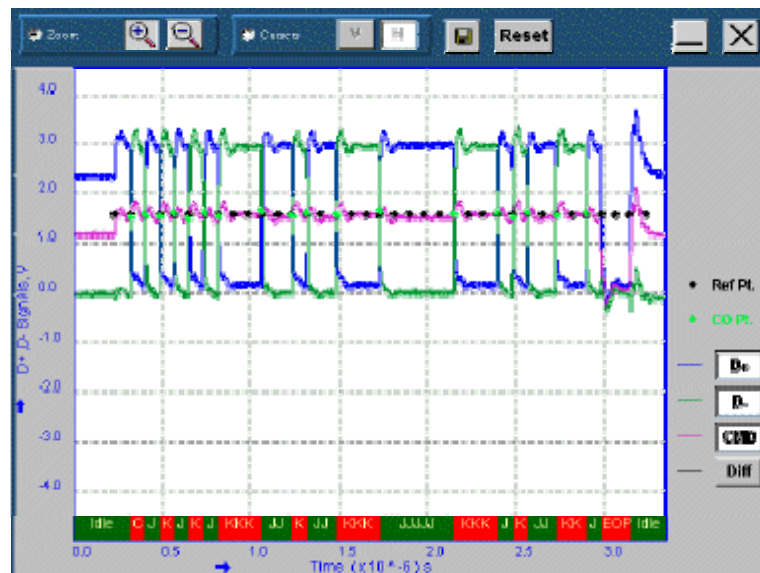



Figure 37: Waveform plot

6. Minimize the eye diagram and waveform plot to view the summary results.
7. The application displays the Results Summary as **PASS** . You can also select the result to view the details of the selected test.
8. To view the Results Details, select Results > Details in the application menu bar or PASS command button in the Overall Result area to view the details of each measurement.

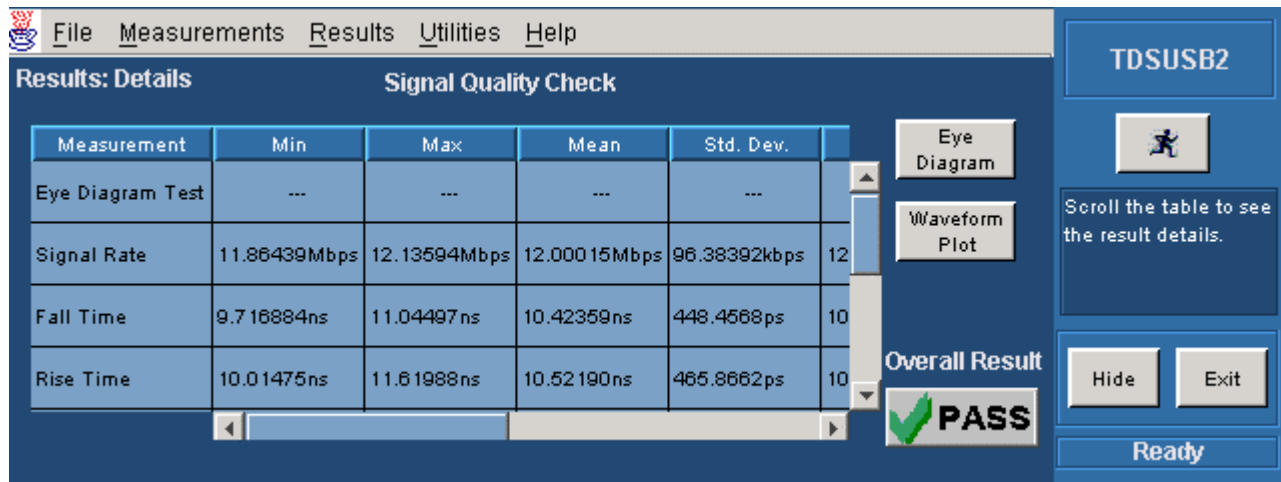

Figure 38: Results details for Signal Quality Check

9. Select Utilities> Report Generator in the application menu bar to generate the Report.
10. You can view the default screen with the Tektronix Specific Format enabled. The report directory appears with a default file name. You can change the file name if you want. Click on the Generate button.
11. Click the Generate button. The application generates an HTML file in C:\TekApplications\tdsusb2\report. To view this report, open it in an HTML viewer or a browser.

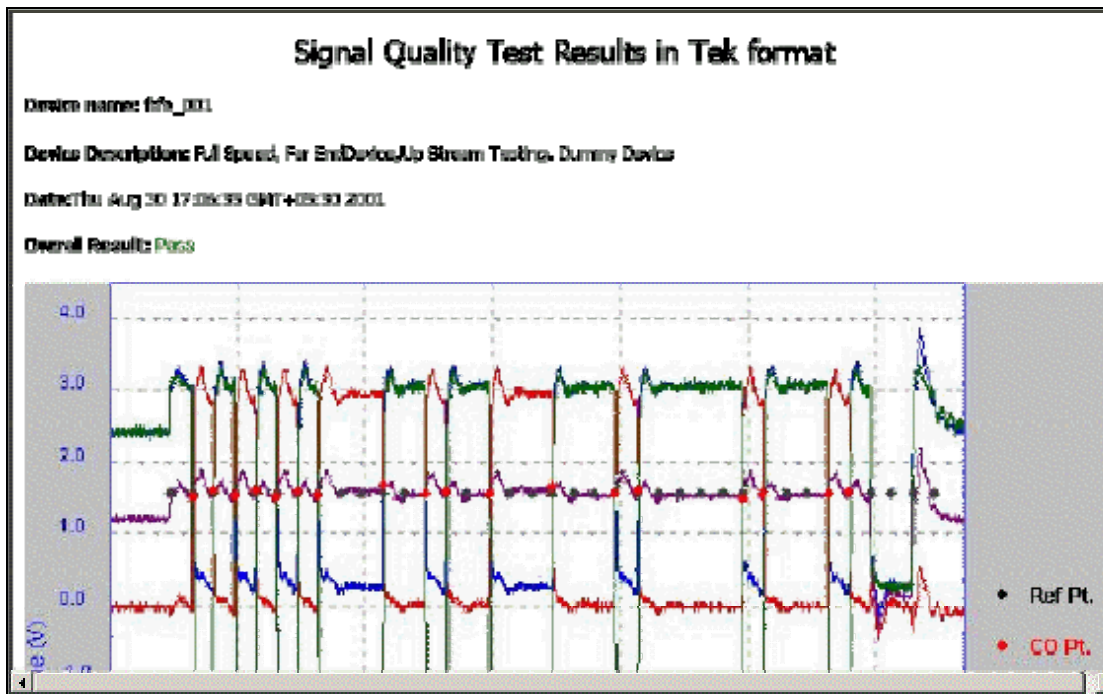



Figure 39: Report in Tektronix-Specific format for Signal Quality Test

Taking a Low Speed Inrush Current Measurement

This section discusses how to take a Low Speed Inrush Current Measurement, view the results, and generate a report. To perform these tasks, the application must be installed and enabled on a supported oscilloscope.

1. To set the application to default values, select File> Recall default. The application displays the message 'Default setup recalled successfully.'
2. Select Measurements> Low Speed tab.
3. Select Inrush Current measurement.
4. Select Measurements> Configure tab and use the default settings set by the application.
5. Select the Source tab. Select From File.
6. Select file C:\TekApplications\tdsus2\tsvfiles\LS_inrush.tsv.
7. Select the  command button to run the application.
8. The application displays the Results Summary as Conditional PASS.
9. You can also select the result to view the details of the selected tests.

10. Select Results> Details from the application menu bar to view Results Details.

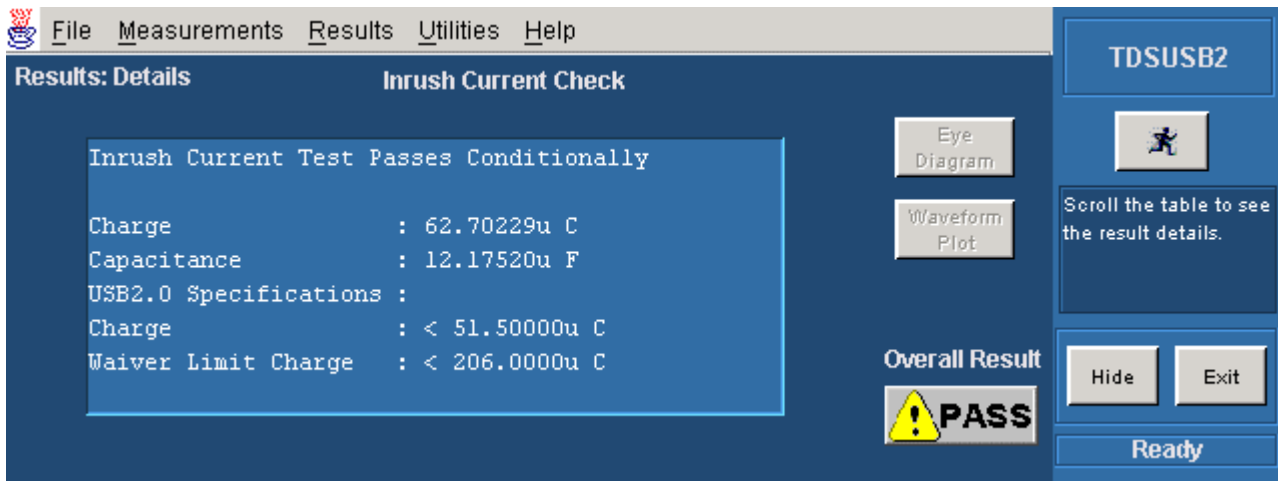

Figure 40: Results details for Inrush Current Check

11. Select Utilities> Report Generator in the application menu bar to generate a report.
12. Select the CSV Specific Report and use the default file name. Select the Generate button.
13. The application displays the sample report file in a browser.

	A	B	C	D	E	F	G
1				Inrush Report			
2	USB2.0 Test Package	Version 1.0.0					
3	Device ID	fsfe_001					
4	Device Description	Full Speed	Dummy Device				
5	Time Stamp	Wed Jan 16 18:27:03 GMT+05:30 2002					
6							
7	Measurement	Unit	Charge	Capacitance	USB Limits	Waiver Limits	Status
8	Inrush Test	-	82.70229u C	12.17520u F	<= 51.50000u C	<= 206.0000u C	Conditional Pass
9							
10							
11							
12							
13							
14							
15							
16							
17							
18							
19							
20							
21							
22							
23							
24							
25							

Figure 41: Report for Inrush Current in CSV format

Taking a High Speed Signal Quality Measurement

This section discusses how to take a High Speed Signal Quality measurement, view the results, and generate the report. To perform these tasks, the application must be installed and enabled on a supported oscilloscope.

To take a High Speed Signal Quality measurement, follow these steps:

1. To set the application to default values, select File > Recall Default. The application displays the message 'Default setup recalled successfully.'
2. Select Measurements> High Speed and select all the Signal Quality measurements in the Signal Quality Check area using Select All button.
3. Select the Configure option or go to Measurements> Configure.
4. Select the Source tab> From File>Browse and locate the file.
5. Select the file C:\TekApplications\tdsub2\tsvfiles\HS_sqc.tsv.
6. Select the  command button to run the application. The application automatically displays the Eye Diagram and the Waveform Plot.

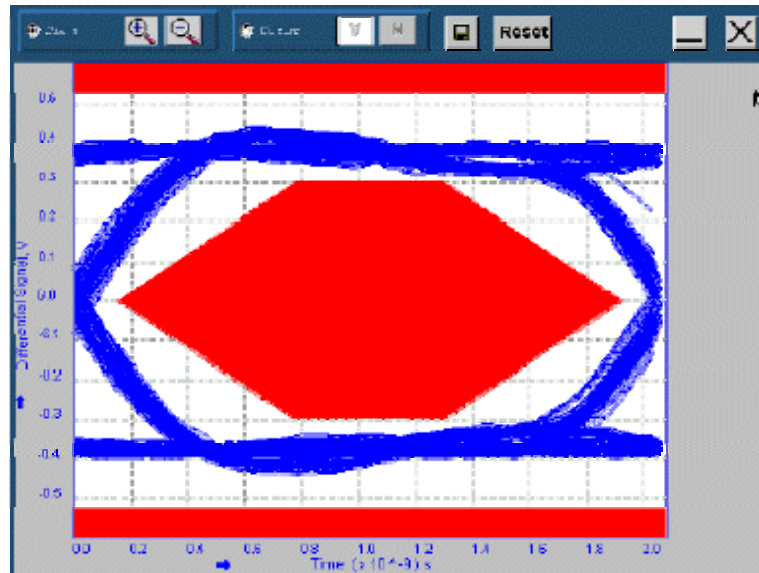

Figure 42: Eye diagram for a High Speed Signal Quality Measurement

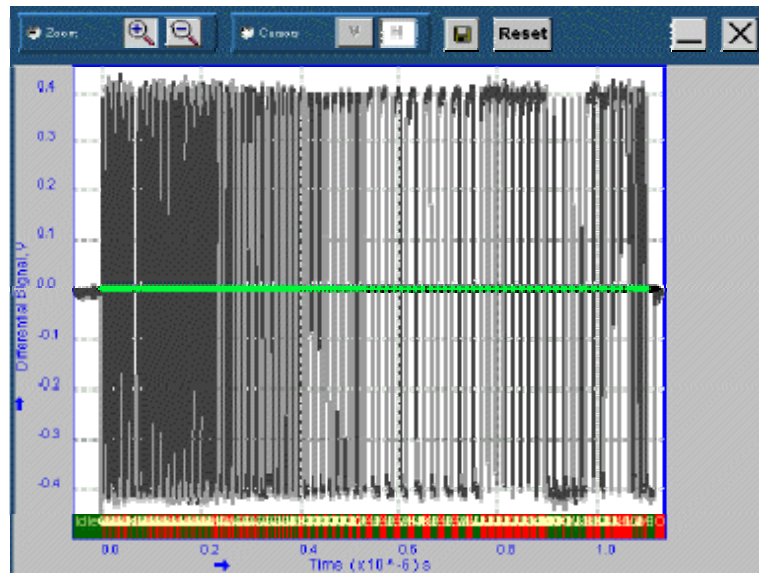

Figure 43: Waveform plot for a High Speed Signal Quality Measurement

7. Minimize the eye diagram and the waveform plot button to view the summary results.
8. Select Results> Details in the application menu bar to view the Results Details. Click the Additional Information button to display the additional information.

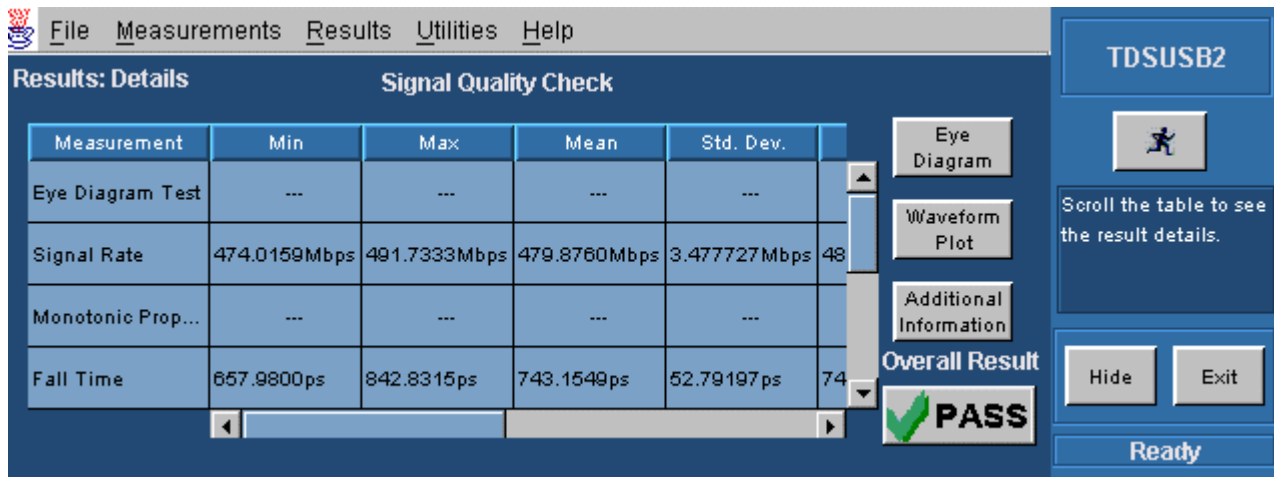

Figure 44: Results details for a High Speed Signal Quality Measurement

9. Select Utilities> Generate Report to generate the report.
10. Select the Report format as Plug-Fest Specific and use the default file name. Select Generate.
11. The application displays the sample report file in a browser.

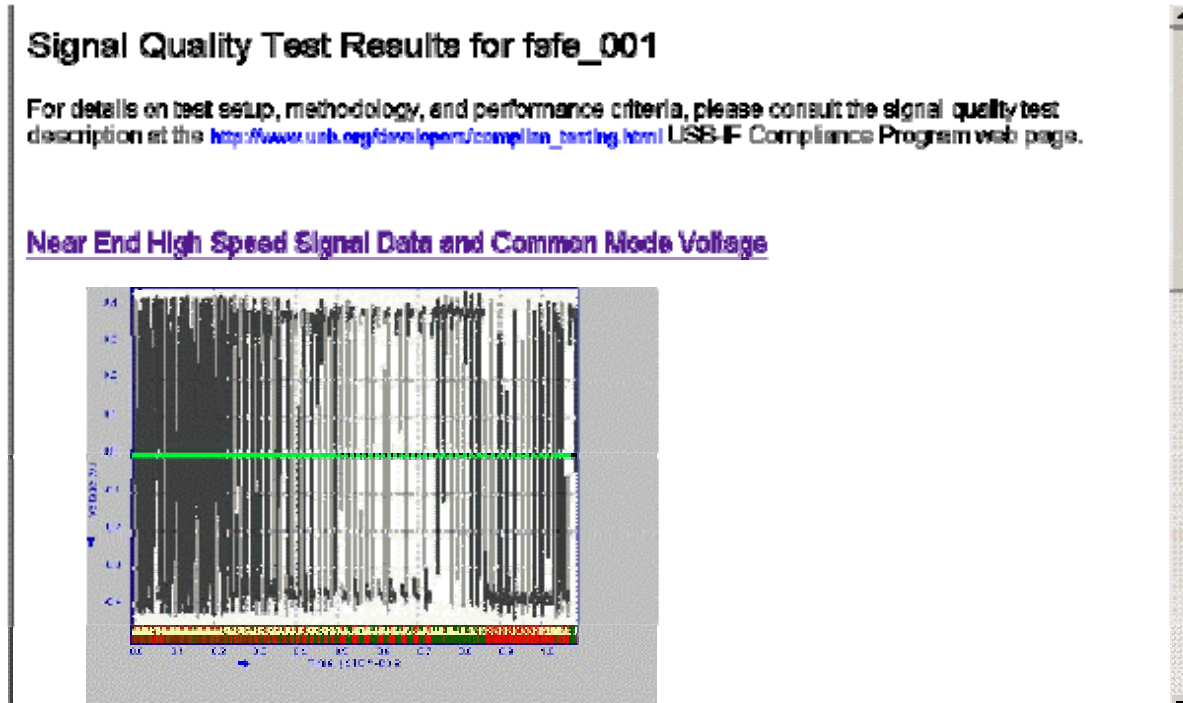

Figure 45: Report in Plug-Fest format for High Speed Signal Quality Measurement

Taking a Low Speed Signal Quality Measurement

This section discusses how to take a Low Speed Signal Quality measurement, view the results, and generate a report. To perform these tasks, the application must be installed and enabled on a supported oscilloscope. View [Installing the application](#) to install the application.

To take a Low Speed Signal Quality measurement, follow these steps:

1. To set the application to default values, select File> Recall Default. The application displays the message 'Default setup recalled successfully.' Select OK to view a screen image showing the default settings.
2. Select the Low Speed tab and select the Signal Quality measurements in the Signal Quality Check area using Select All button.
3. Select the Configure tab or select Measurements> Configure. The Measurements: Configure default settings display.
4. Select the Measurements: Source. If the source is Live or Ref, configure the appropriate channels for D+, D- and Qualifier. You have to always select D+ first. If you select any one of the Live channels CH1-CH4 for D+ source, the remaining Live channels are selected from the D- and the Qualifier channel source. If you select any one of the Ref channels Ref1-Ref4 for D+ source, the remaining Ref channels are selected from the D-. There is no Qualifier channel source for the Ref signals.

If the source is from a file, use the browse button to look for the file.

Select the file C:\TekApplications\tdsusb2\tsvfiles\LS_SQC.tsv.

5. Select the  command button to run the application. The application displays the Eye Diagram and the Waveform Plot.

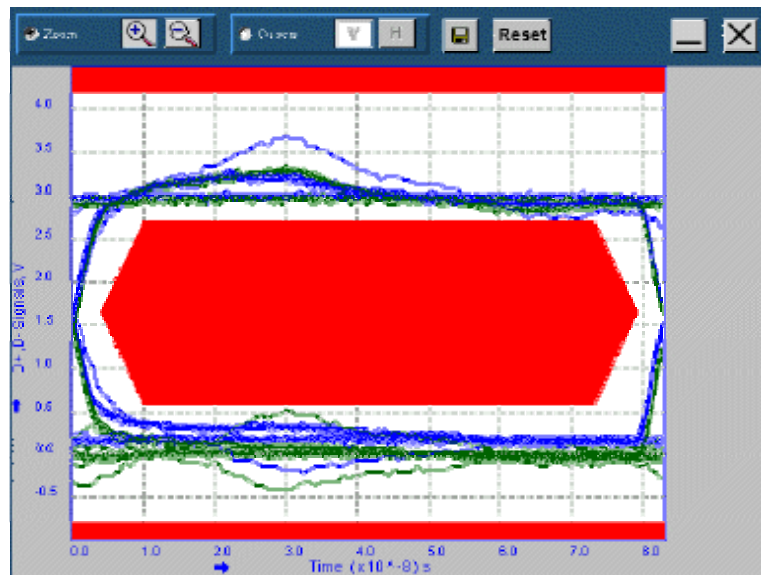

Figure 46: Eye diagram for Low Speed Signal Quality Measurement

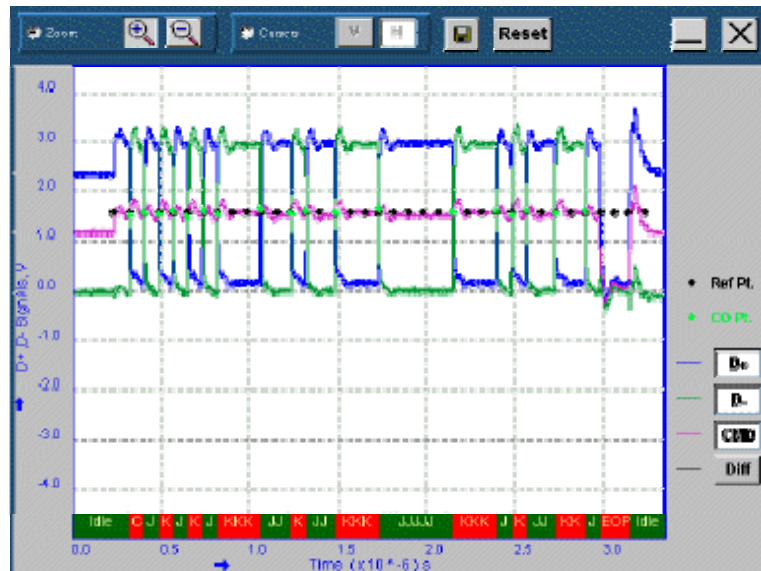



Figure 47: Waveform plot for Low Speed Signal Quality Measurement

6. Minimize the eye diagram and waveform plot to view the summary results.
7. The application displays the Results Summary as **PASS** . You can also select the result to view the details of the selected test.
8. To view the Results Details, select Results > Details in the application menu bar or PASS command button in the Overall Result area to view the details of each measurements.

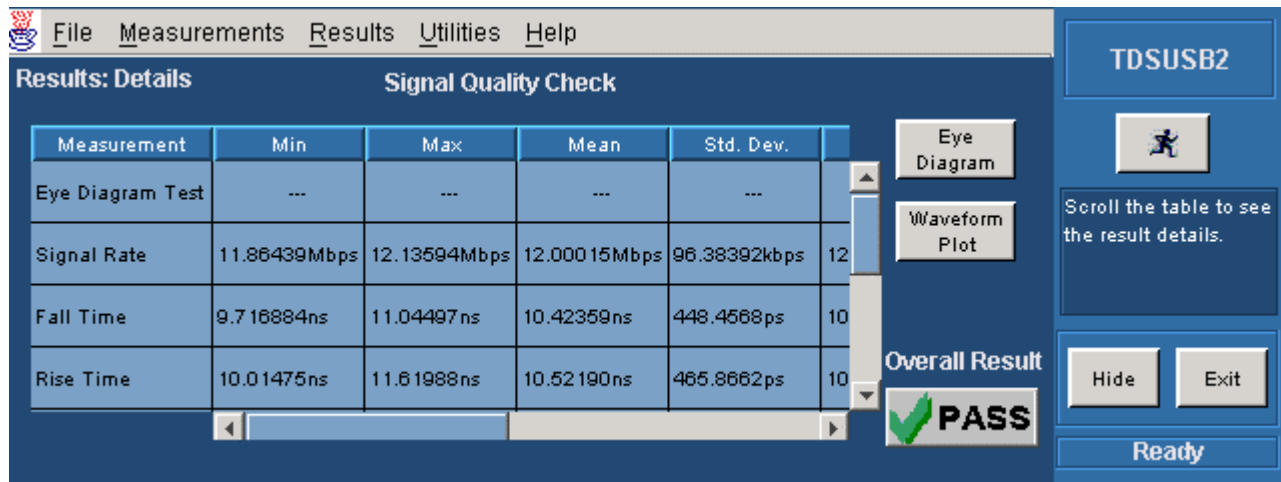

Figure 48: Results details for Low Speed Signal Quality Measurement

9. Select Utilities> Report Generator in the application menu bar to generate the Report.
10. You can view the default screen with the Tektronix Specific Format enabled. The report directory appears with a default file name. You can change the file name if you want. Click the Generate button.
11. Click the generate button. The application generates an HTML file in C:\TekApplications\tdsusb2\report. To view this report, open it in an HTML viewer or a browser.

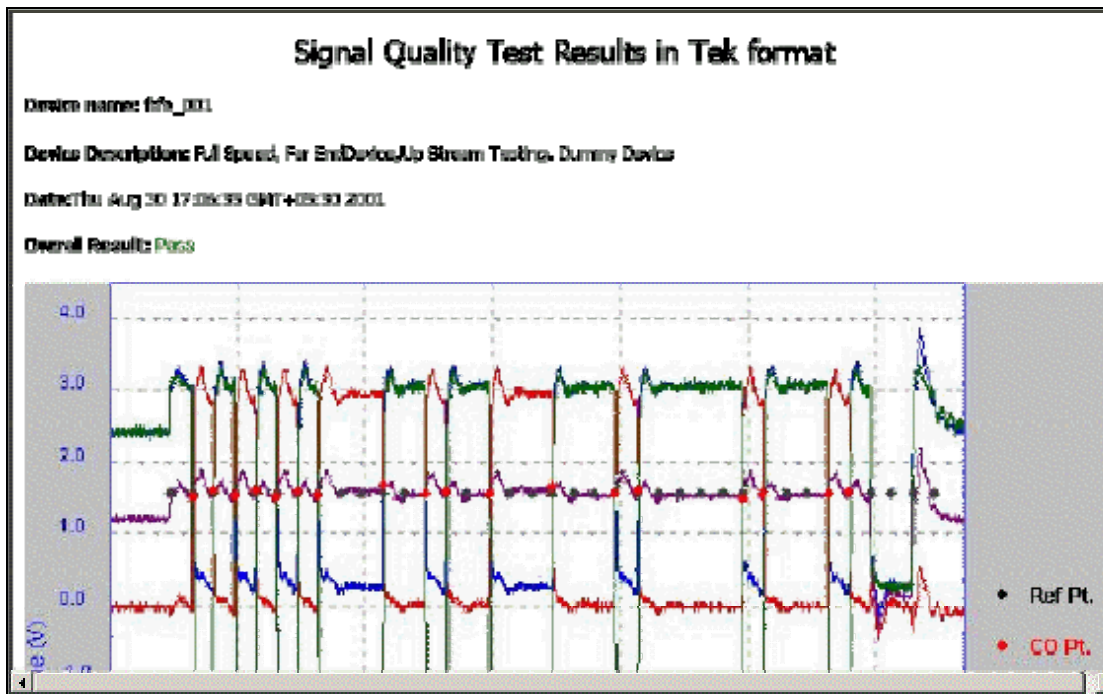

Figure 49: Report in Tektronix-Specific format for Low Speed Signal Quality Measurement

Application Examples

This section presents the application examples. The simplified examples highlight the application measurements and show how to use the application to solve your test problems.

To use these examples, you must have the TDSUSB2 application installed and enabled on the oscilloscope. Connect the probes to your unit under test (UUT), and perform the configuration tasks. For information, see [Installing the application](#) and [Starting the Application](#).

Full Speed Signal Quality Tests for Downstream Testing

Specifying the Equipment-Full Speed Signal Quality Downstream Tests

The following equipment is needed for downstream signal quality check on a Full Speed device testing:

- Tektronix digital oscilloscope
- TDSUSB2 application
- TDSUSBF compliance test fixture
- Three P6245 or TAP1500 single-ended voltage probes

Typical Equipment Setup-Full Speed Signal Quality Downstream Tests

To set up the equipment for Full Speed Signal Quality Downstream test, follow these steps:

1. Set the S6 switch to the Init position.
2. Use the adapters to connect the A receptacle from Device SQ test section (marked DUT) of the test fixture to the USB2.0 Low Speed device.
3. Connect Ch1 of the D+ probe to the D+ pins on the Device SQ section of the test fixture.
4. Connect Ch2 of the D- probe to the D- pins on the Device SQ section of the test fixture.
5. Connect the Init port of the Device SQ section of the test fixture to any port of the unit under test (hub) using the USB cable.

6. Select the measurement and select the  command button to run the application.
7. Select OK after acquiring a waveform. Verify that it is a correct waveform.

Note: Make sure the acquired signal is a valid waveform.

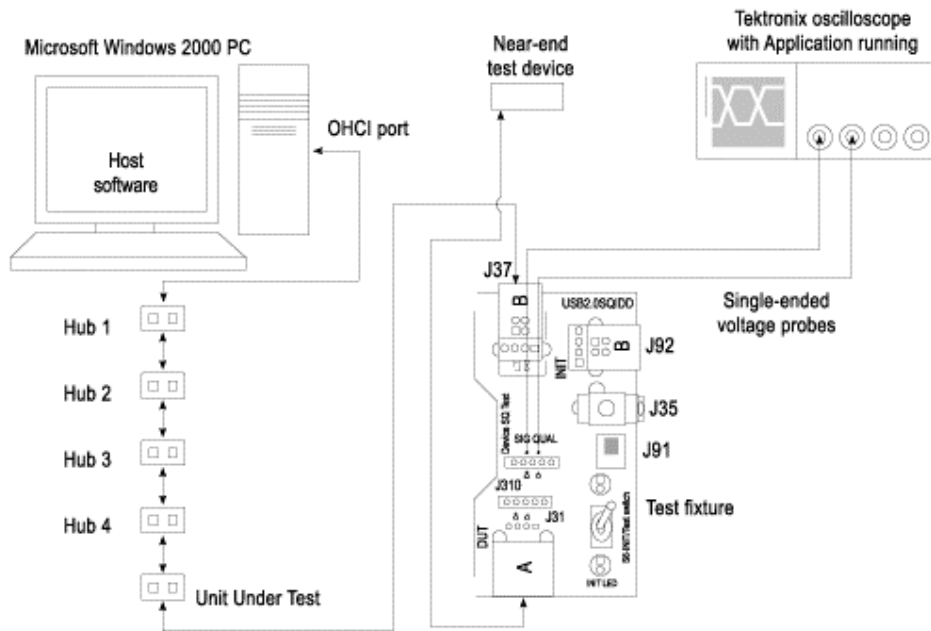

Figure 50: Equipment setup for Full Speed Signal Quality Measurement for downstream testing

Selecting and Configuring Measurements-Full Speed Signal Quality Tests

Follow the steps to select measurements for Full Speed Signal Quality check:

1. From the application menu, select Measurement > Select> Full Speed tab.
2. Select the following signal quality checks:
 - Eye Diagram Test
 - Signal Rate
 - Paired JK Jitter
 - Paired KJ Jitter
 - Consecutive Jitter
 - EOP Width

- Cross-Over Voltage
 - Rise Time
 - Fall Time
3. Select the Select All toggle button to select all the measurements simultaneously. Click on any measurement button to deselect it.

Configuring the Measurement

Follow the steps to configure the selected measurements:

1. From the application menu, select Measurement> Configure> Configure.
2. Configure the following options:

Table 10. Configuring Measurements

Option	Set to
Tier	Tier6
Direction	Downstream
Test Point	Set the test point to Far End

3. Select the Source tab.
4. Configure the following options:

Table 11. Configure options

Option	Set to
Live/Ref	Single-ended

5. If you select Single-ended, you must select two channels for D+ and D-.
6. Select  to acquire the data.
7. The application automatically displays the eye diagram and waveform plot of the signal acquired from the unit under test.

Viewing Results-Full Speed Signal Quality Tests

To view the results of the tests, follow these steps:

1. From the application menu, select Results> Summary.

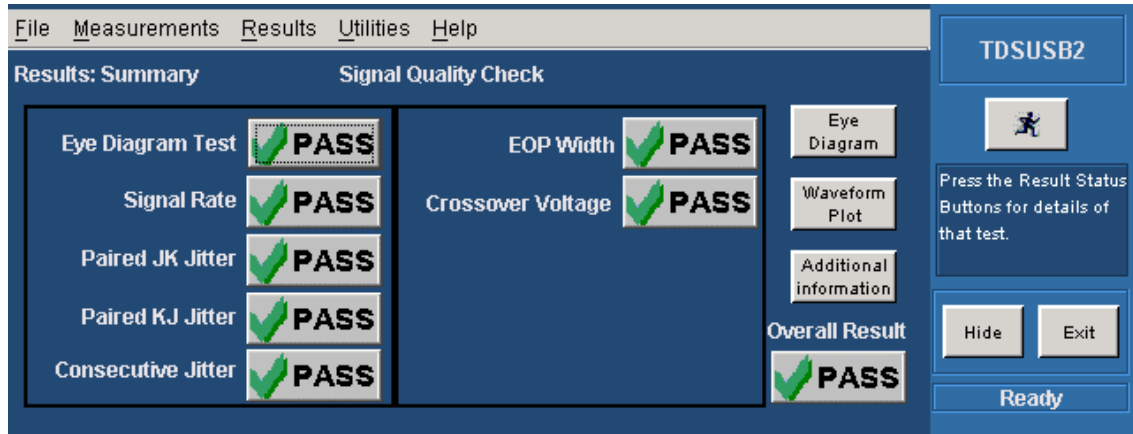



Figure 51: Results summary for Full Speed Signal Quality Measurement

2. Click on any of the test result  buttons to get the details of that test.
3. From the application menu, select Results> Details.

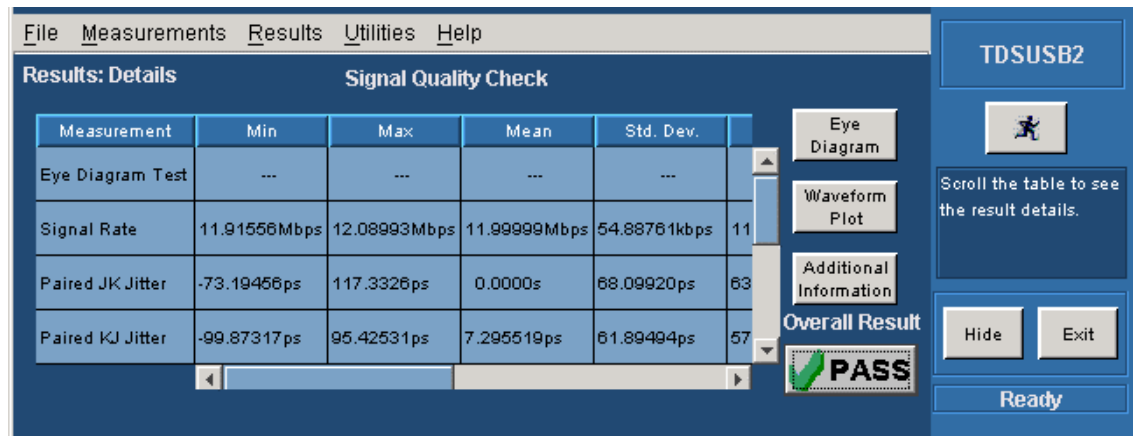

Figure 52: Results details for Full Speed Signal Quality Measurement

4. Click the Eye Diagram option in Results Summary or the Details to view the Eye Diagram.
5. Click the Waveform Plot option to view the annotated waveform plot.

Generating Reports-Full Speed Signal Quality Tests

To generate reports of the test results, follow these steps:

1. From the application menu, select Utilities> Report Generator.
2. Select any one of the Report Formats: Tektronix Specific, Plug-Fest Specific or CSV format.

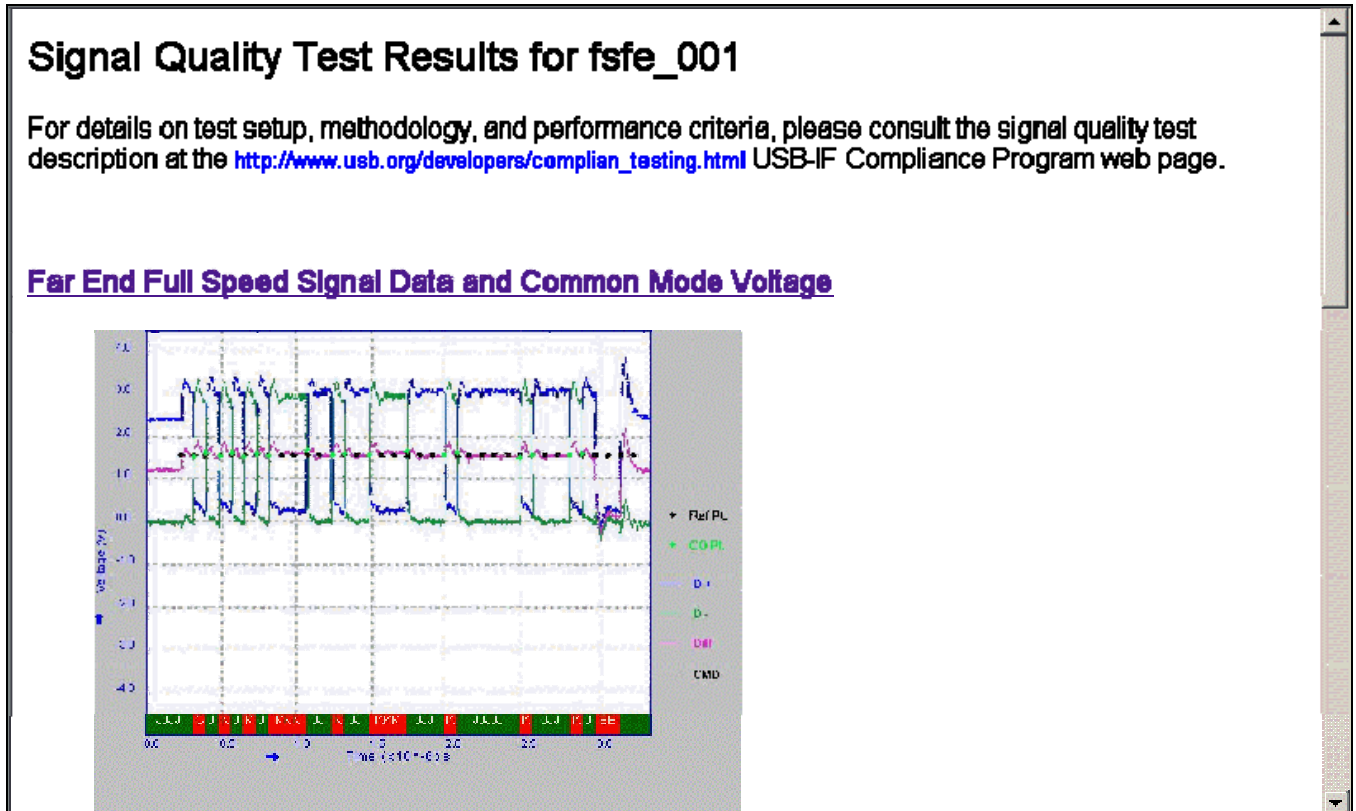

Figure 53: Report in Plug-Fest format for Full Speed Signal Quality Measurement

3. Select the manual generation mode.
4. Select the Generate button to display and view the selected report format.

Note: You can view the Plug-Fest specific report format as HTML pages and the .csv format in Microsoft Excel.

Droop Test for Ports of Hub

Specifying the Equipment-Low Speed Droop Tests

The following equipment is needed to perform a Droop Test for Low Speed device:

- Tektronix digital oscilloscope
- TDSUSB2 application
- TDSUSBF compliance test fixture
- Two P6245 or TAP1500 single-ended probes

Typical Equipment Setup-Low Speed Droop Tests

To set up the equipment for Droop test, follow these steps:

1. Use the Droop and Adjacent Trigger section for the Droop test. Use standard USB cable to connect the loads on the test fixture to the ports of the unit under test as shown in the following figure.
2. The setup requires two channels of the oscilloscope: one for the Droop Load Trigger Timer that is on the Droop test load section, and the other for VBUS that is on the Adjacent Trigger and Droop Test section of the test fixture. Use the load switch to select appropriate loads for Droop Test.
3. In the Droop and Adjacent Trigger section on the test fixture, probe Ch1 from the VBUS and ground the pins.
4. In the Droop Test Load section on the test fixture, probe Ch2 from the oscillator (marked OSC) and ground the pins.
5. Connect the Droop Trigger Test Load to the Port1 of the unit under test (hub).
6. Connect the Load1 to Port2 of the hub under test.
7. Connect the Load2 to the A receptacle of the Droop and Adjacent Trigger section on the test fixture. Connect the A pin dangle from the Droop and Adjacent Trigger section to the Port4 of the unit under test (hub). Port4 is the port under test of the hub.
8. Connect the Load3 to Port3 of the unit under test (hub). Now all the ports of the unit under test are connected (hub).

9. Select the measurement and select the  command button to run the application.
10. Select OK when the valid waveform is acquired.
11. Observe the droop in the VBUS when Droop test load is applied.

Note 1: The application automatically sets up the oscilloscope to acquire the Droop signal. If you do not get a valid signal, set up the oscilloscope accordingly.

Note 2: Use the Load Switch to select 500 mA test loads for Droop testing of a self powered hub and system. Use the Load Switch to select 100 mA test loads for Droop testing of bus powered hub and system. Use the Load Switch to select 500 mA test loads for Droop testing of self powered hub and system.

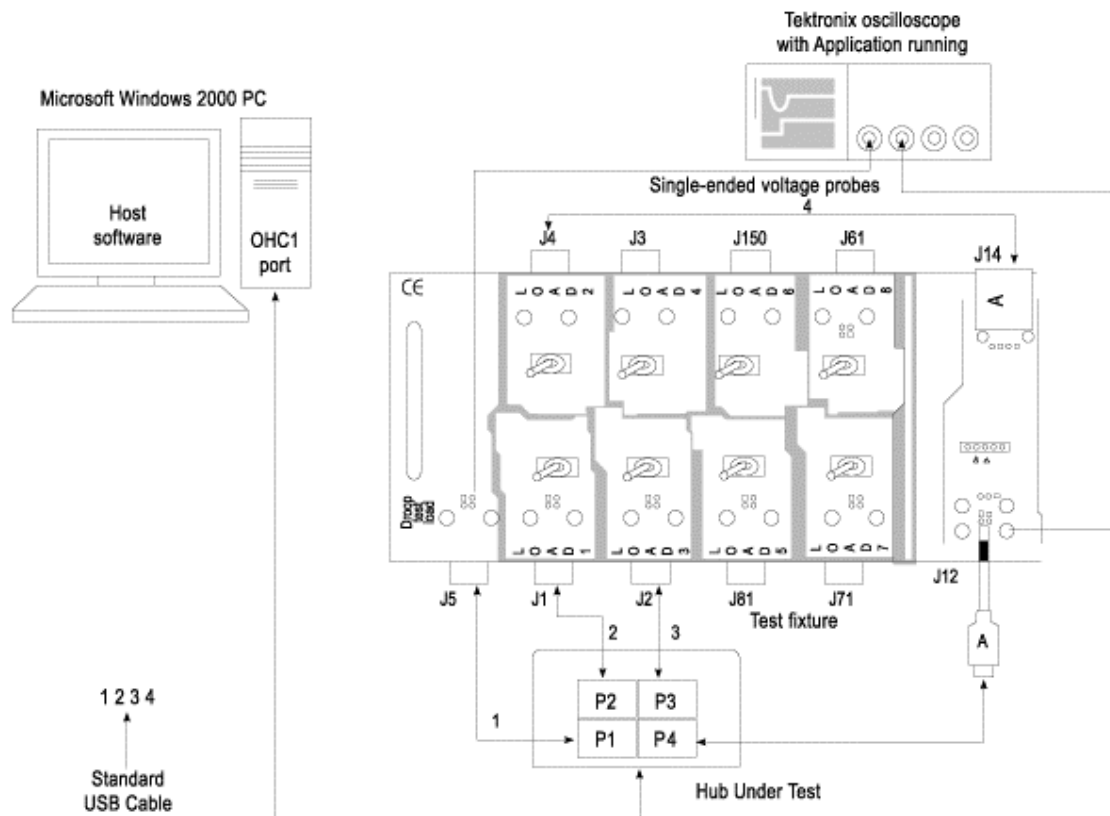

Figure 54: Equipment setup for Low Speed Droop test

Selecting and Configuring Measurements-Droop Tests

From the application menu, select Measurement> Select> Droop Test.

Configuring the Measurement

Follow the steps to configure the selected measurement:

1. From the application menu, select Measurement> Configure.
2. Configure the following options:

Table 12. Configuring measurement

Option	Set to
Port	Port under test
Source	Downstream
V _{BUS}	Ch1
Trigger	Ch2
Device type	Self-powered

3. Select  to acquire the data.
4. After acquiring the data, the application displays the eye diagram and the waveform plot automatically.

Viewing Results-Droop Tests

To view the results of the tests, follow these steps:

1. Run the application and from the application menu, select Results> Summary.
2. Click on any of the test result buttons to get the details of that test.
3. From the application menu, select Results> Details.
4. Click on the Eye Diagram option in Results Summary or Results Details to view the Eye Diagram.
5. Click on the Waveform Plot to view the annotated waveform plot.

Generating Reports-Droop Tests

To generate reports of the test results, follow these steps:

1. From the application menu, select Utilities> Report Generator.
2. Select any one of the Report Formats: Tektronix Specific, Plug-Fest Specific or CSV format.
3. Select Manual option to generate the report.
4. Select the Generate button to display and view the selected report format.

Note: You can view the Plug-Fest specific report format as HTML pages and the .csv format in Microsoft Excel.

Full Speed Signal Quality Tests for Upstream Testing

Specifying the Equipment-Full Speed Signal Quality Tests for Upstream Testing

The following equipment is needed for upstream signal quality check on a low or full speed device:

- Tektronix digital oscilloscope
- TDSUSB2 application
- TDSUSBF compliance test fixture
- Three P6245 or TAP1500 single-ended voltage probes

Typical Equipment Setup-Full Speed Signal Quality Tests for Upstream Testing

To set up the equipment for Full Speed Signal Quality test for Upstream, follow these steps:

1. Use the A receptacle to connect the USB unit under test (device) to the Inrush Droop section of the test fixture.
2. Connect the Qualifier device to the Adjacent Trigger and Droop section of the test fixture as shown in the following figure.
3. Connect Ch1 of the D+ probe to the D+ pins on the Inrush Droop section of the test fixture.
4. Connect Ch2 of the D- probe to the D- pins on the Inrush Droop section of the test fixture.
5. Connect the D+ (D- for Low speed) pin of the Adjacent Trigger and Droop Section of the test fixture to Ch3 as shown in the following figure.
6. Use the connectors to connect the A pin dongle from the Adjacent Trigger and Droop section of the test fixture to one port of the Hub 5. Use the A pin dongle from the Inrush Droop section of the test fixture to another port of the Hub 5.
7. Select the measurement and select the  command button to run the application.
8. Select OK after acquiring a waveform. Verify that it is a correct waveform.

Note: Use the standard USB cables to connect between the hubs. Keep the Discharge switch in the Inrush Droop section in the ON position.

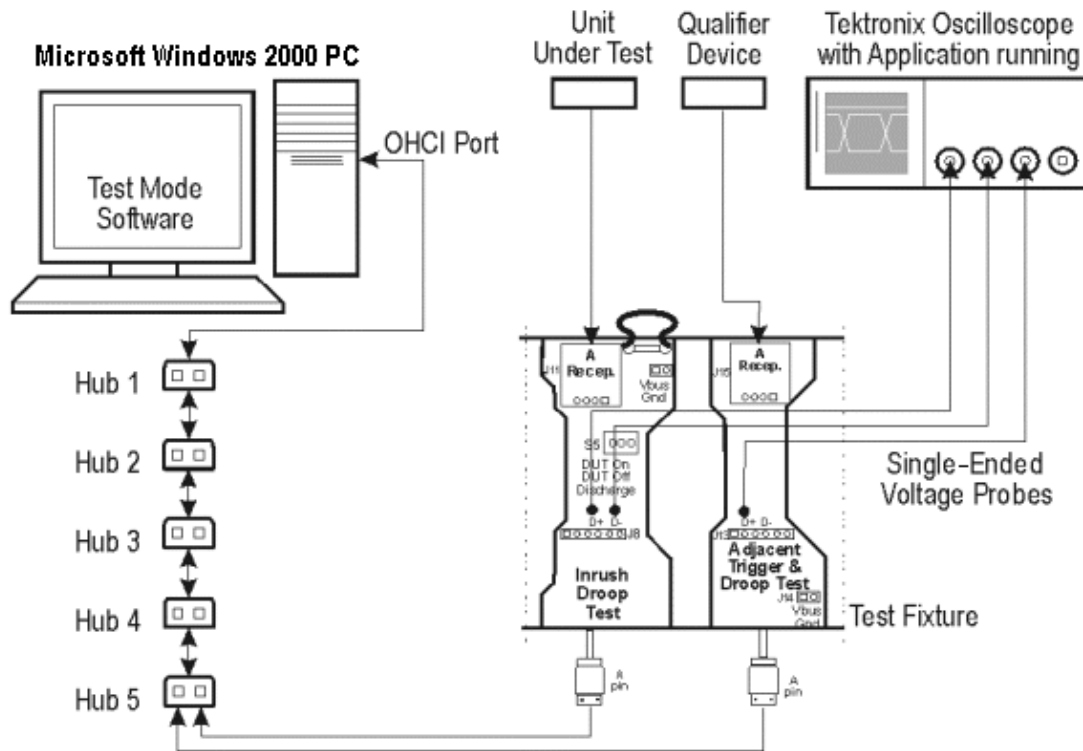

Figure 55: Equipment setup for Full Speed Signal Quality Measurement for upstream testing

Selecting and Configuring Measurements-Full Speed Signal Quality Tests for Upstream Testing

Follow the steps to select measurements for Full Speed Signal Quality check:

1. Select Measurements> Select > Full Speed tab.
2. Select Signal Quality tests:
 - Eye Diagram Test
 - Signal Rate
 - Paired JK Jitter
 - Paired KJ Jitter
 - Consecutive Jitter
 - EOP Width
 - Cross-Over Voltage
 - Rise Time
 - Fall Time

3. Select the Select All toggle button to select all the measurements simultaneously. Click on any measurement button to deselect it.

Configuring the Measurement

Follow the steps to configure the selected measurement:

1. From the application menu, select Measurement> Configure> Configure tab.
2. Configure the following options:

Table 13. Configuring measurement

Option	Set to
Tier	Tier6
Direction	Upstream
Test Point	Far End

3. Select the Source tab.
4. Configure the following options:

Table 14. Configuring options

Option	Set to
Live/Ref	Single-ended Ch1, Ch2
Qualify Channel	Ch3

5. Select  to acquire the data.
6. The application automatically displays the Eye Diagram and the Waveform Plot of the signal acquired from the unit under test.

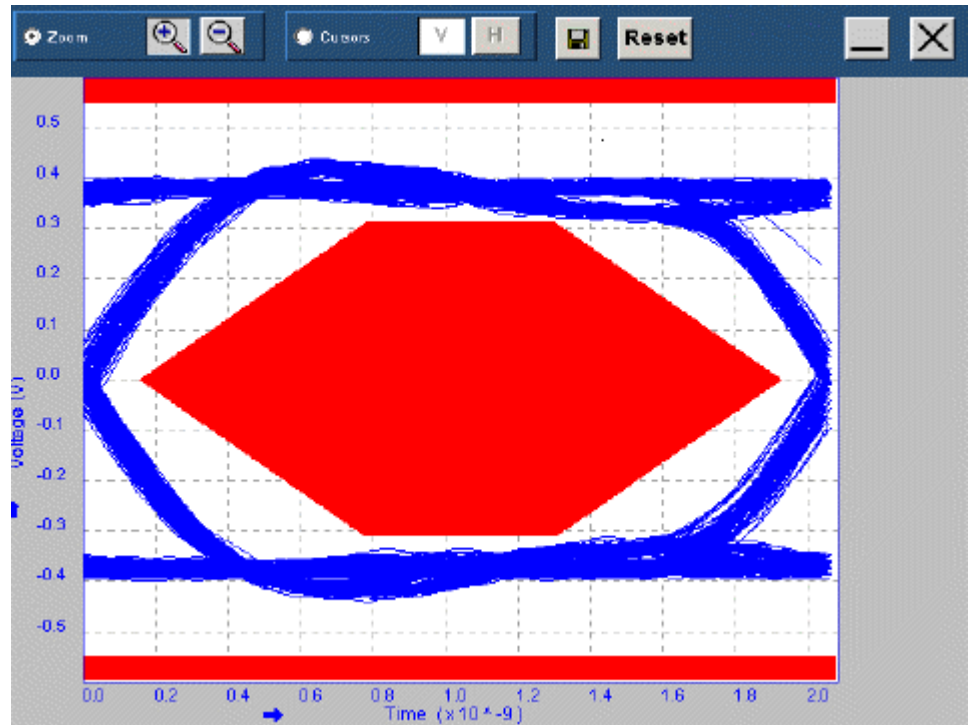

Figure 56: Eye diagram for Full Speed Signal Quality Measurement for upstream testing

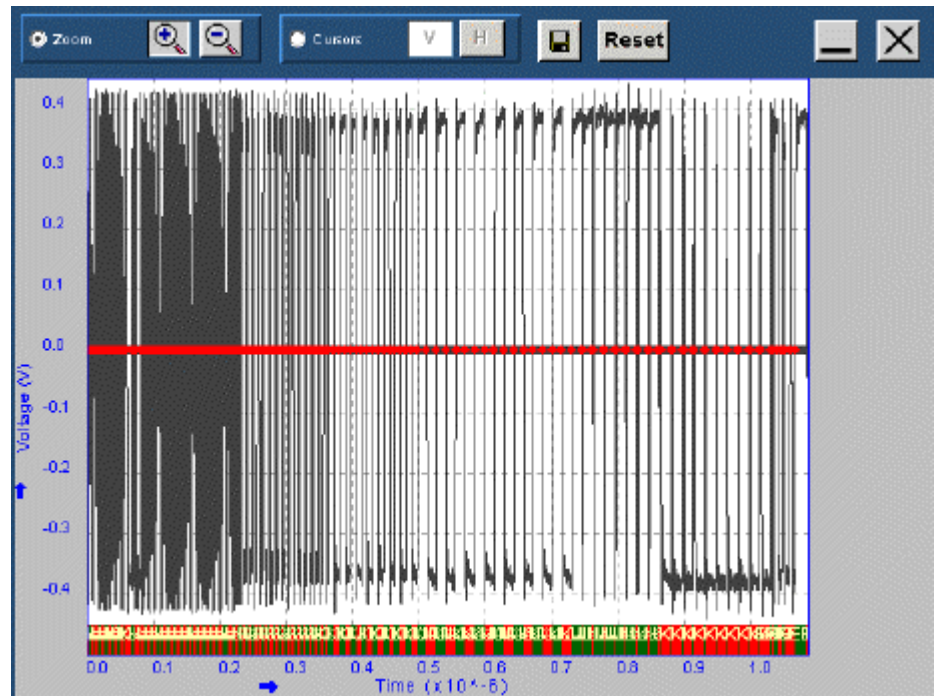

Figure 57: Waveform plot for Full Speed Signal Quality Measurement for upstream testing

Viewing Results-Full Speed Signal Quality Tests for Upstream Testing

To view the results of the tests, follow these steps:

1. Run the application and from the application menu, select Results> Summary.
2. Click any of the test result buttons to get the details of that test.
3. From the application menu, select Results> Details.
4. Click the Eye Diagram option in Results Summary or Results Details to view the Eye Diagram.

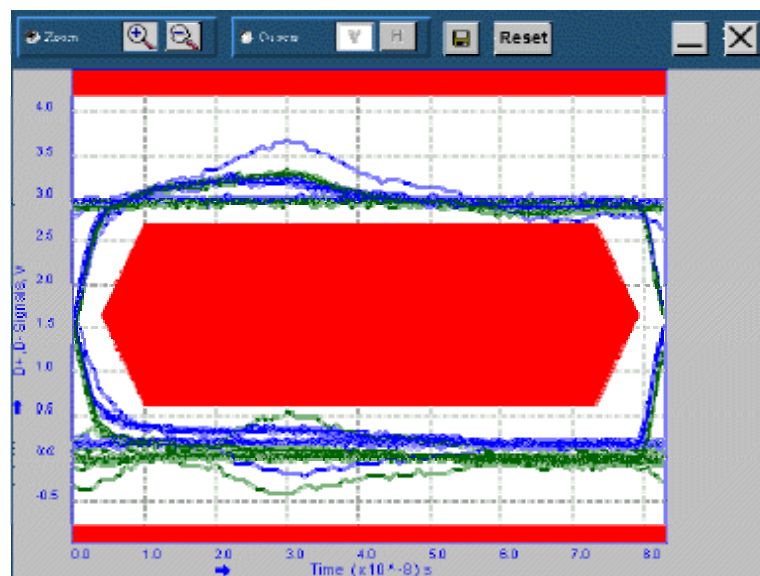

Figure 58: Eye diagram for Full Speed Signal Quality Measurement for upstream testing

5. Click the Waveform Plot to view the annotated waveform plot.

Generating Reports-Full Speed Signal Quality Tests for Upstream Testing

To generate reports of the test results, follow these steps:

1. From the application menu, select Utilities> Report Generator.
2. Select any one of the Report Formats: Tektronix, Plug-Fest Specific or CSV format.
3. Select the Manual option to generate the report.
4. Select the Generate button to display and view the selected report format.

Note: You can view the Plug-Fest specific report format as HTML pages and the .csv format in Microsoft Excel.

Inrush Current Test for a Device

Specifying the Equipment-Full Speed Inrush Current Test

The following equipment is needed for Inrush Current Check on a Full Speed Device:

- Tektronix digital oscilloscope
- TDSUSB2 application
- TDSUSBF compliance test fixture
- One TCP202 current probe

Typical Equipment Setup-Inrush Current Test

To set up the equipment for Inrush test, follow these steps:

1. Use the dongles on the Inrush section of the test fixture to connect it to the host system.
2. Connect the current probe between the V_{BUS} loop wire on the Inrush section on the Test fixture and Ch1 of the oscilloscope.
3. Configure the measurement and select the  command button to run the application.

4. Connect the unit under test to the A Receptacle of the Inrush section of the test fixture and observe the Inrush current signal.
5. Select OK after acquiring a waveform. Verify that it is a correct waveform.

Note: To avoid the triggering of Inrush signals and false inrush current by the discharge switch, place the inrush discharge switch in the ON position and hot-plug the unit under test (device). In case a valid Inrush signal is not acquired, use the cursor mode in File > Preferences or set up the oscilloscope to get a valid waveform.

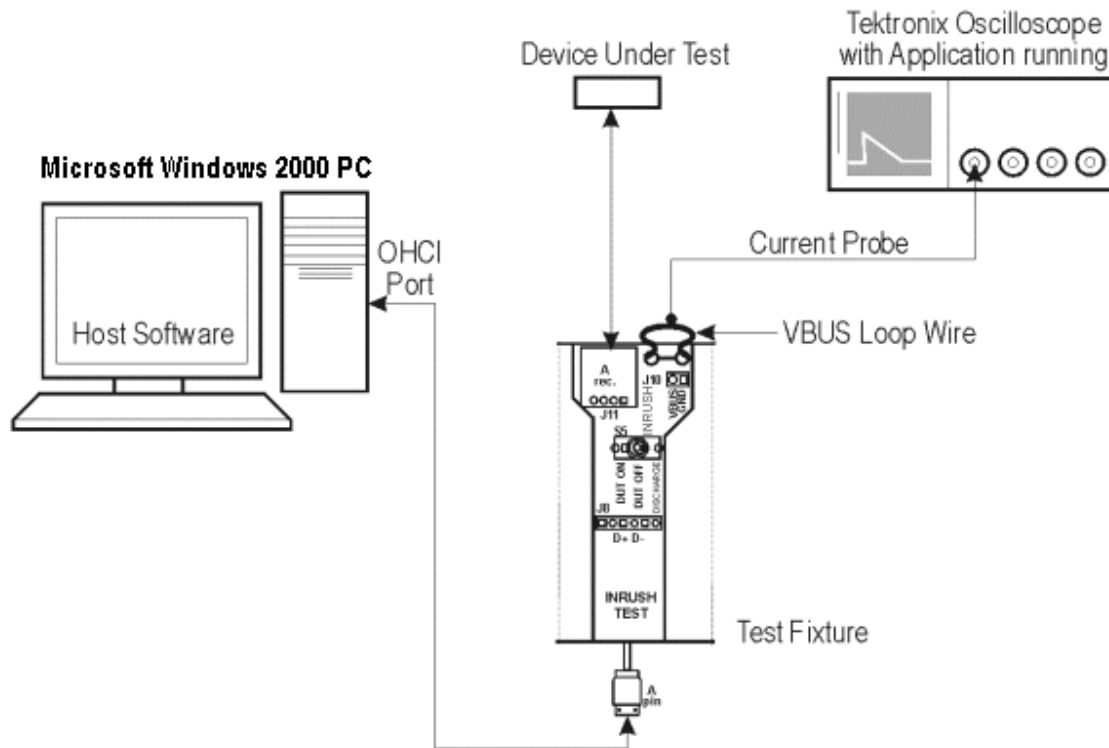

Figure 59: Equipment setup for Full Speed Inrush Current test

Selecting and Configuring Measurements-Inrush Current Test

From the application menu, select Measurement> Select> Inrush Current.

Configuring the Measurement

Follow the steps to configure the selected measurement:

1. From the application menu, select Measurement> Configure> Configure tab.
2. Configure the following options:

Table 15. Configuring measurement

Option	Set to
Tier	Tier is always set to 1
V _{BUS}	Enter voltage measured across VBUS manually
Device Type	Hot Plug Attach

3. Select the Source tab.
4. Configure the following options:

Table 16. Configuring options

Option	Set to
Live/Ref	Channel acquiring the signal

5. Select Run.

Viewing Results-Inrush Current Test

To view the results of the tests, follow these steps:

1. Run the application and from the application menu, and select Results> Summary.
2. Click any of the test result buttons to get the details of that test.
3. From the application menu, select Results> Details.
4. Click the Eye Diagram option in Results Summary or Results Details to view the Eye Diagram.
5. Click the Waveform Plot to view the annotated waveform plot.

Generating Reports-Inrush Current Test

To generate reports of the test results, follow these steps:

1. From the application menu, select Utilities> Report Generator.
2. Select any one of the Report formats – Tektronix Specific, Plug-Fest Specific or CSV format.

Measurement	Unit	Charge	Capacitance	USB Limits	Waiver Limits	Status
Inrush Test	-	62.70229u C	12.17520u F	< 51.50000u C	< 208.0000u C	Conditional Pass

Figure 60: Report in CSV format for Inrush Current test

3. Select the manual report generation mode.
4. Select the Generate button to display and view the selected report format.

Note: You can view the Plug-Fest specific report format as HTML pages and the .csv format in Microsoft Excel.

Signal Quality Tests for High Speed Devices

Specifying the Equipment-Signal Quality Tests for High Speed Devices for Upstream Testing

The following equipment is needed for signal quality tests on a High Speed device for upstream testing:

- Tektronix digital oscilloscope
- TDSUSB2 application
- TDSUSBF compliance test fixture
- One P6248 differential probe

Typical Equipment Setup-Signal Quality Tests for High Speed Devices for Upstream Testing

To set up the equipment for the High Speed Signal Quality test, follow these steps:

1. Set the S6 switch to the Init position.
2. Connect the standard USB cable between the Device SQ Init port and the host port.
3. Connect the A receptacle from the Device SQ test port of the test fixture to the unit under test (device).
4. Configure the measurement and select the  command button to run the application.
5. Place the device in the test mode Test_Packet from the host controller.
6. Set the test Init switch to the test position to isolate the unit under test while maintaining the bus power.
7. Select OK after acquiring a waveform. Verify that it is a correct waveform.
8. If the signal is clipped, follow these steps to increase the vertical scale:
9. In the oscilloscope menu, select Vertical>Vertical Setup to display the Channel screen.
10. In the Scale field, increase the vertical scale values until the waveform is completely displayed in the screen.

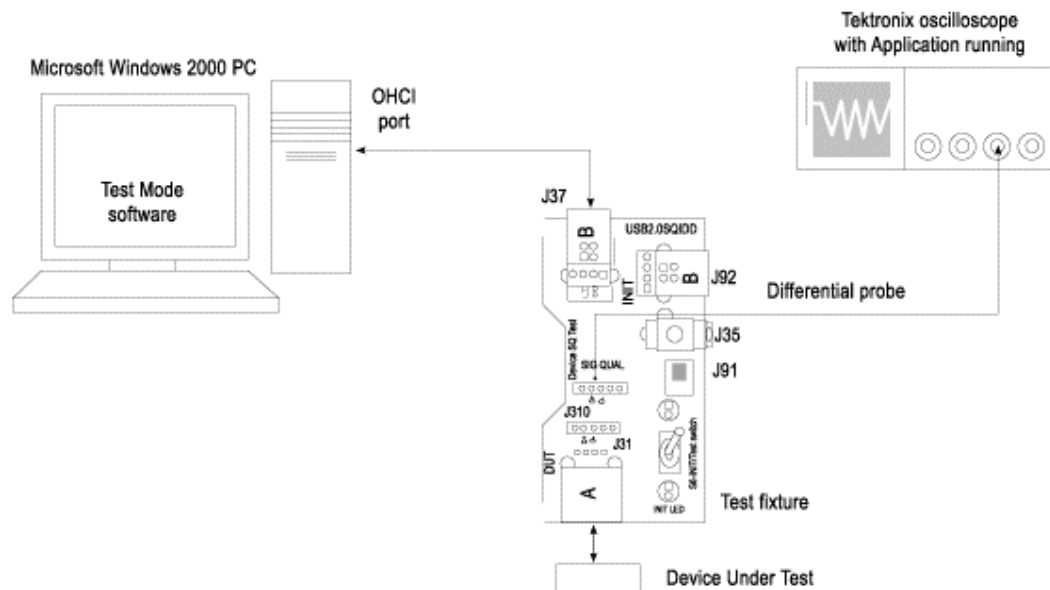

Figure 61: Equipment setup for Signal Quality Measurement for high-speed devices for upstream testing

Selecting and Configuring Measurements-Signal Quality Tests for High Speed Devices for Upstream Testing

Follow the steps to select measurements for High Speed Signal Quality check:

1. From the application menu, select Measurement> Select> High speed (tab).
2. Select the tests:
 - Eye Diagram Test
 - Signal Rate
 - EOP Width
 - Rise/Fall Time
 - Monotonic Property
3. Select the Select All toggle button to select all the measurements simultaneously. Click on any measurement button to deselect it.

Configuring the Measurement

Follow the steps to configure the selected measurements:

1. From the application menu, select Measurement> Configure> Configure tab.
2. Configure the following options:

Table 17. Configuring measurements

Option	Set to
Tier	Tier1
Direction	Upstream
Test Point	Set the test point to Near End

3. Configure the following options in the Source field:

Table 18. Configuring options

Option	Set to
Live/Ref	Differential

4. Select  to acquire the data.
5. The application automatically displays the Eye Diagram and Waveform Plot of the signal acquired from the unit under test. This is possible if you enable the automatic display of the eye diagram and the waveform plot in the Preferences menu.

Viewing Results-Signal Quality Tests for High Speed Devices for Upstream Testing

To view the results of the tests, follow these steps:

1. Run the application and from the application menu, select Results> Summary.

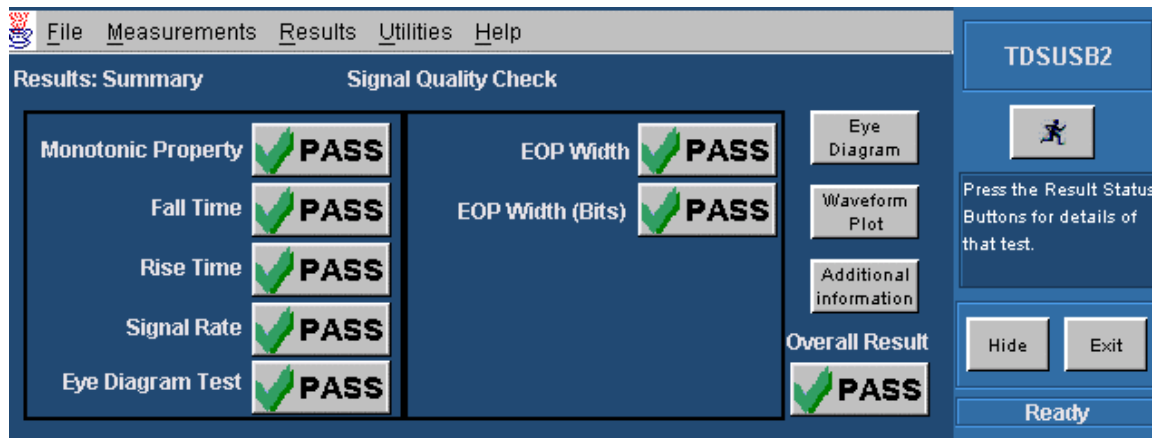

Figure 62: Results summary for Signal Quality Measurement for high-speed devices for upstream testing

2. Click any one of the test result buttons to get the details of that test.
3. Click the Additional Information button to display the additional information.
4. From the application menu, select Results> Details.

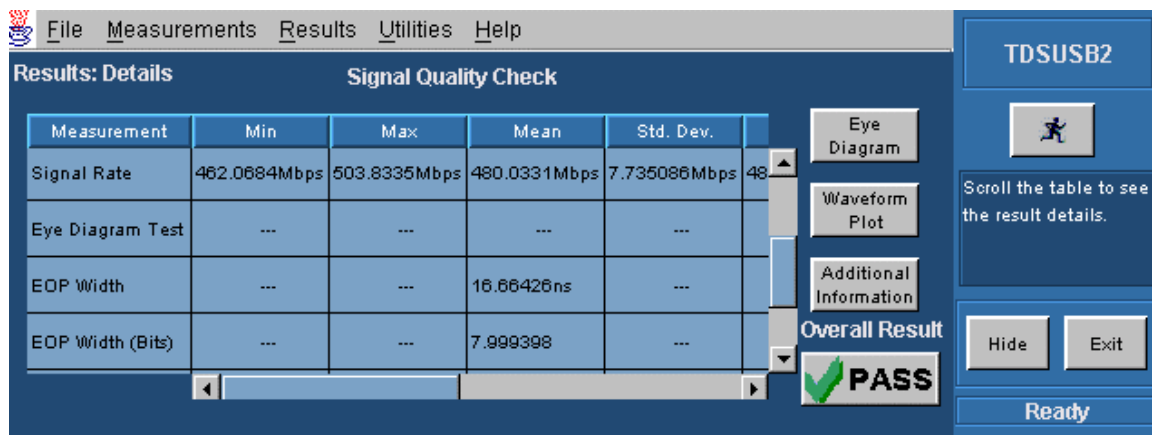

Figure 63: Results details for Signal Quality Measurement for high-speed devices for upstream testing

5. Click the Eye Diagram in Results Summary or the Results Details to view the eye diagram.

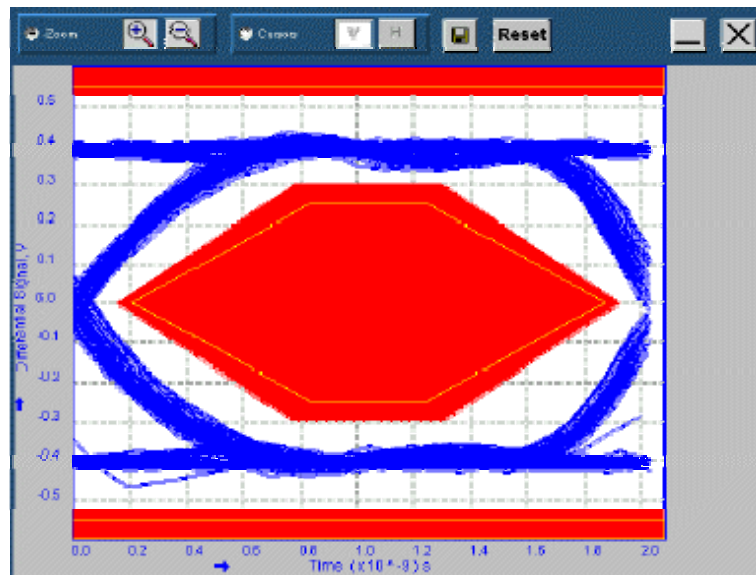

Figure 64: Eye diagram for Signal Quality Measurement for high-speed devices for upstream testing

6. Click the Waveform Plot to view the waveform plot.

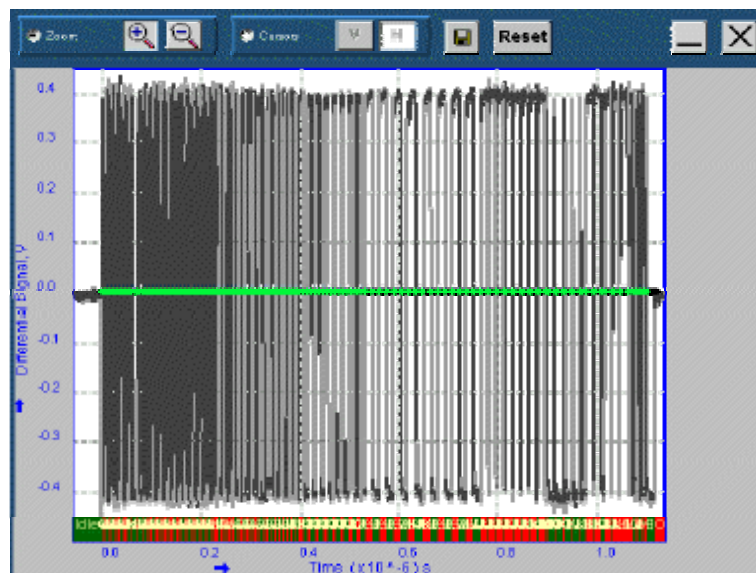

Figure 65: Waveform plot for Signal Quality Measurement for high-speed devices for upstream testing

Generating Reports-Signal Quality Tests for High Speed Devices for Upstream Testing

To generate reports of the test results, follow these steps:

1. From the application menu, select Utilities> Report Generator.
2. Select any one of the Report formats: Tektronix Specific, Plug-Fest Specific or CSV format.

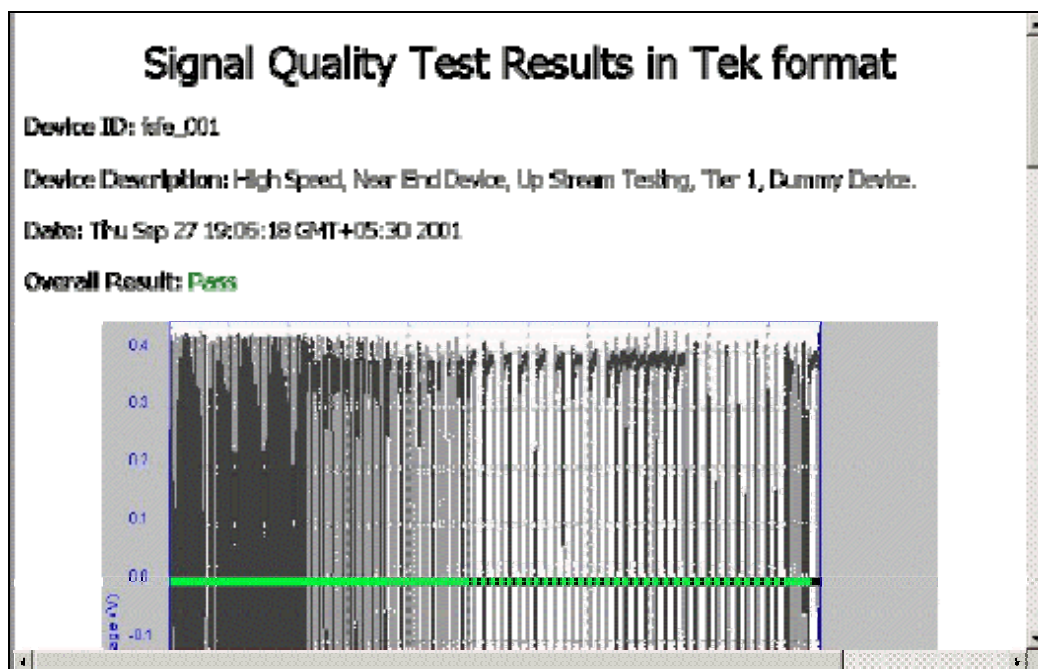

Figure 66: Report in Tektronix-Specific format for Signal Quality Measurement for high-speed devices for upstream testing

3. Select the manual generation mode.
4. Select the Generate button to display and view the selected report format.

Note: You can view the Plug-Fest specific report format as HTML pages and the .csv format in Microsoft Excel.

Packet Parameter Measurement

Specifying the Equipment-Packet Parameter Measurement

The following equipment is needed for a Packet Parameter measurement:

- Tektronix digital oscilloscope
- TDSUSB2 application
- TDSUSBF compliance test fixture
- One P6248 differential probe
- Host Controller (Host controller card with the test mode software on a Microsoft Windows PC)

Typical Equipment Setup-Packet Parameter Measurement

Test Fixture Setup

To set up the test fixture, follow these steps:

1. Set the S6 switch to the Init position.
2. Connect the standard USB cable between the Device SQ Init port and the host port.
3. Connect the A receptacle (marked DUT) from the Device SQ test port to the device under test.
4. Apply the power to the test fixture.
5. Apply the power to the DUT.
6. Attach the differential probe near the device connector on the test fixture.

Set up the Oscilloscope for High Speed Host

1. Select the measurement and run the application. The application automatically sets the oscilloscope parameters (Horizontal, Vertical, and Trigger) and displays the message, "Press OK when correct waveform is acquired". You can see the SOFs on the oscilloscope screen.
2. If you are not able to acquire the waveform automatically, perform Autosetup in the oscilloscope to display the SOF.
3. If your DUT is EL_21, EL_23, EL_25, select the Single Step Set Feature option from the HS electrical test tool.

4. If your DUT is EL_22, select the Step button in the HS electrical test tool to acquire the waveform as shown in the following figure:

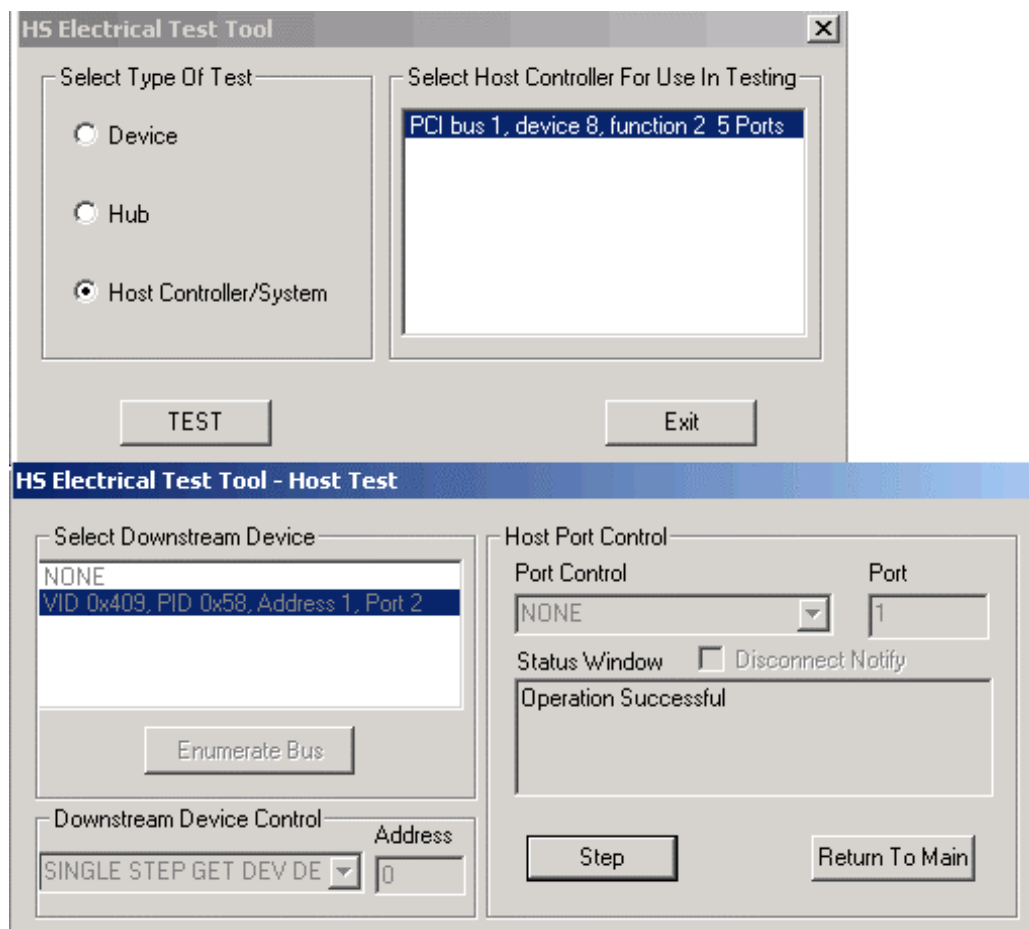

Figure 67: Setting the trigger level

You can use the application to perform the following measurements:

1. High Speed Host: EL_21, EL_23, EL_25 (EOP/II-InterPacketI&II)
 - Complete procedures 1 and 2 to set up the test fixture and the oscilloscope
 - The oscilloscope acquires and displays the waveform
 - "Press OK when correct waveform is acquired"
 - The application measures the synchronous bits (32) of the first and second packets. This is EL_21
 - The application measures the EOP of the second packet (8bits). This is EL_25. As the signal is differential, the EOP can be a positive or a negative pulse

- The application measures the inter-packet gap of the first two packets (88-192 bits). This is EL_23 as shown in the following figure:

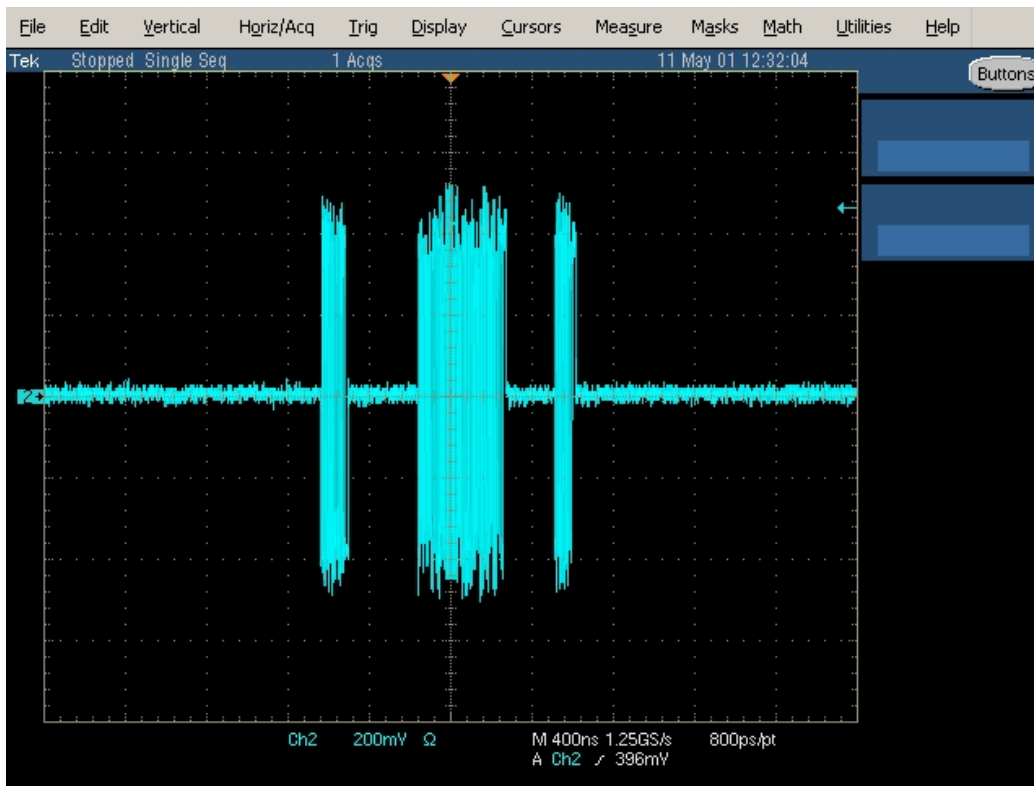

Figure 68: Measuring EL_23

2. High Speed Host: EL_22 (InterPacketII&III)

- Complete procedures 1 and 2 to set up the test fixture and the oscilloscope
- Select the Step button in the HS Electrical Test Tool
- The oscilloscope acquires and displays the waveform as shown in the following figure:



Figure 69: Acquiring the waveform

- “Press OK when correct waveform is acquired”

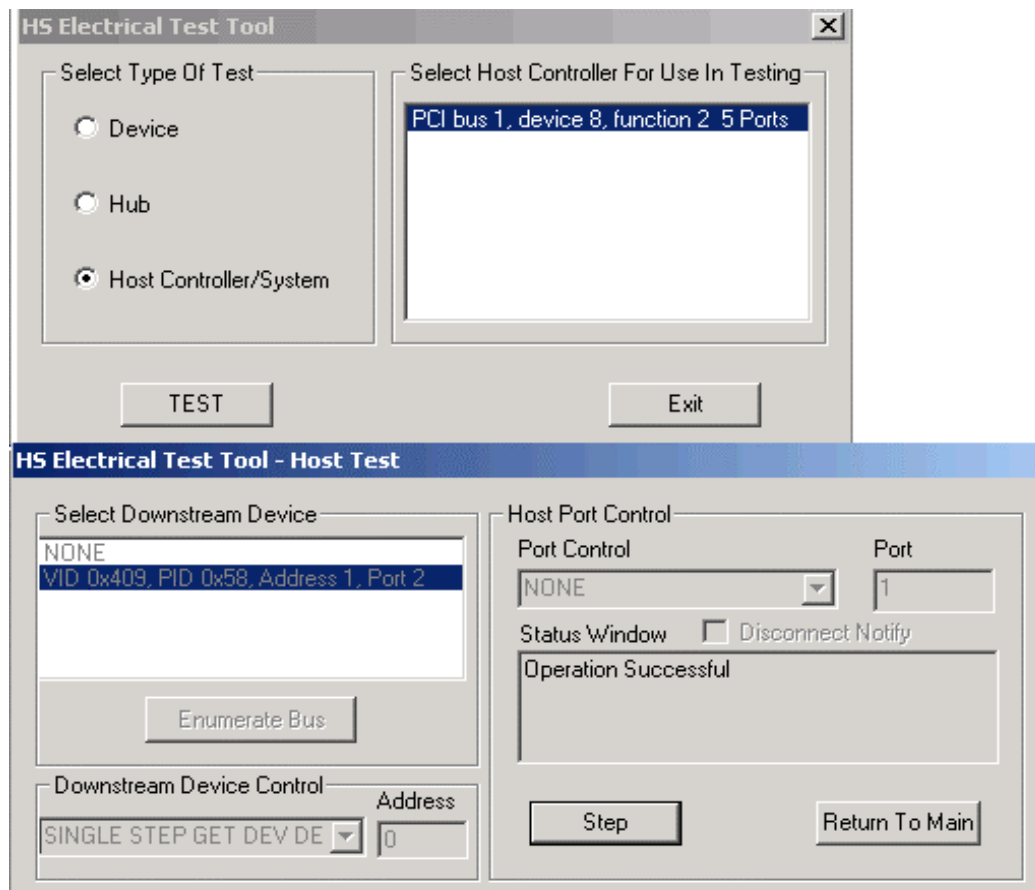

Figure 70: Setting the trigger level

- The application displays the waveform

- The application measures the inter packet gap of the second and the third packet (88-192 bits). This is EL_22
3. High speed Host: EL_55 (SOF-EOP)
- Complete the procedure 1
 - Run the test mode software and select the Host option
 - Select the Enumerate button in the HS electrical test tool to identify the device connected to the host controller
 - Select the measurement and run the application. The application automatically sets the oscilloscope parameters (Horizontal, Vertical, and Trigger). You can see the SOFs on the oscilloscope screen

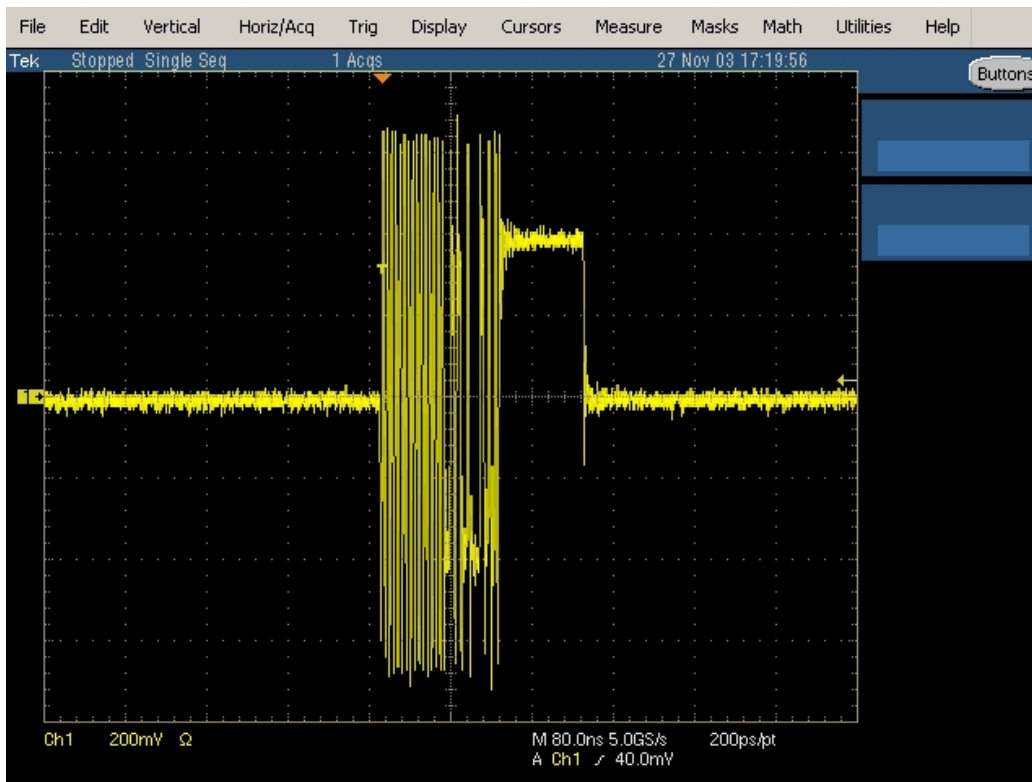

Figure 71: Viewing SOFs

To set up the oscilloscope for the High Speed Device EL_21, EL_23, EL_25 (Sync-EOPIII-InterPacketII&III) and a High Speed Device EL_22 (InterPacketI&II), follow these steps:

1. Select the measurement and run the application. The application automatically sets the oscilloscope parameters (Horizontal, Vertical, and Trigger) and displays the message, Press OK when correct waveform is acquired. You can see the SOFs on the oscilloscope screen.
2. If you are not able to acquire the waveform automatically, perform Autosetup in the oscilloscope to display the SOF.
3. If your DUT is EL_21, EL_23, EL_25, select the Single Step Set Feature option from the HS electrical test tool.
4. If your DUT is EL_22, select the Step button in the HS electrical test tool to acquire the waveform as shown in the following figure:

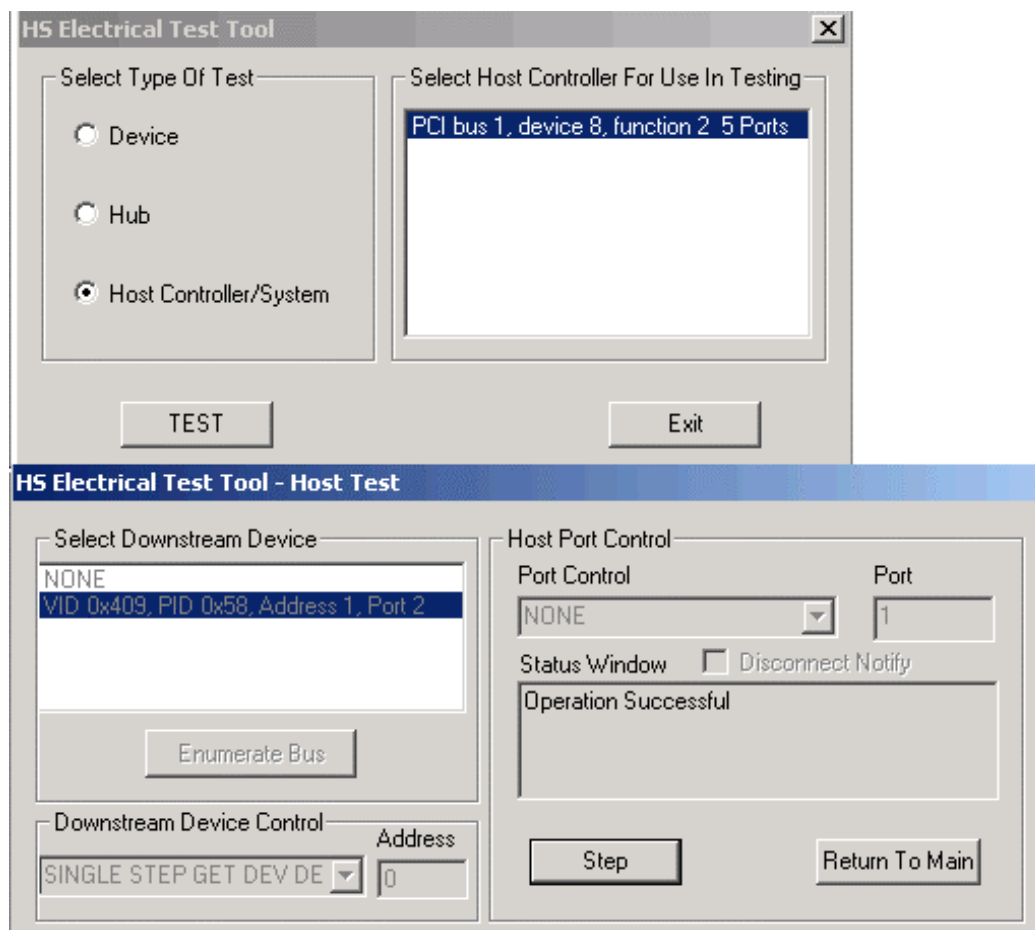

Figure 72: Setting the trigger level

You can use the application to perform the following measurements:

1. High Speed Device:EL_21, EL_23, EL_25 (Sync-EOPIII-InterPacketII&III)
 - Complete procedures 1 and 3 to set up the oscilloscope
 - The oscilloscope acquires and displays the waveform
 - “Press OK when correct waveform is acquired”
 - The application measures the synchronous bits (32) of the third packet. This is EL_21
 - The application measures the EOP of the third packet (8bits). This is EL_25. As the signal is differential, the EOP can be a positive or a negative pulse

- The application measures the inter-packet gap between the second and the third packets (88-192 bits). This is EL_23 as shown in the following figure:

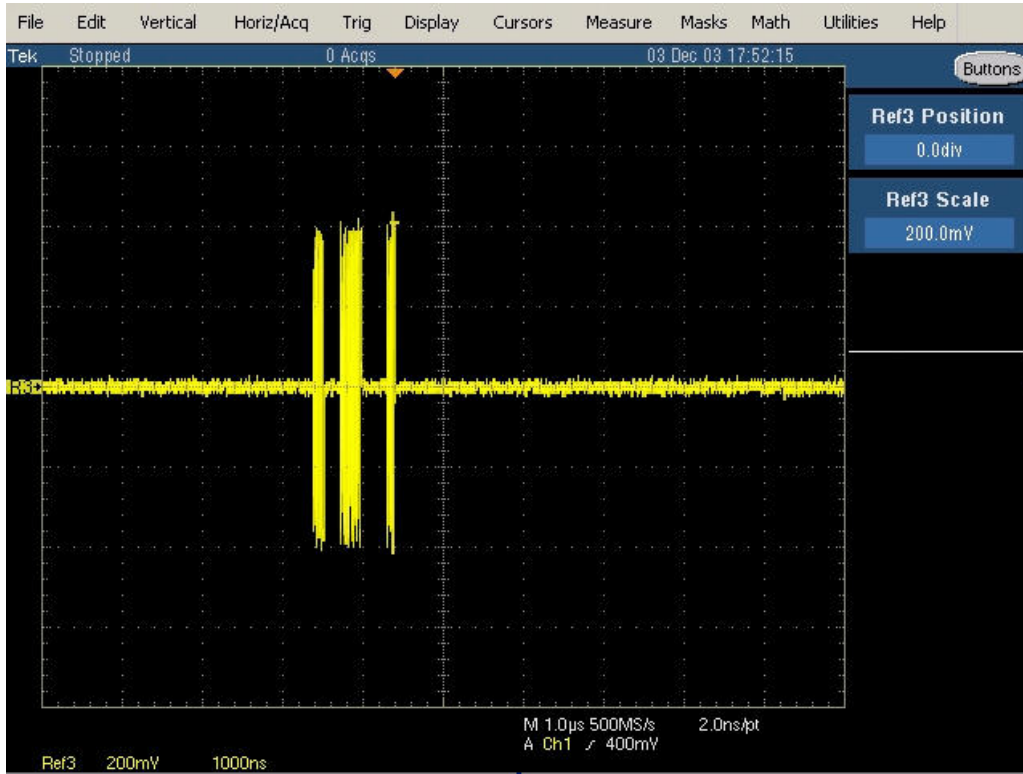

Figure 73: Measuring EL_23

2. High Speed Device:EL_22 (InterPacketI&II)

- Complete procedures 1 and 3 to set up the oscilloscope
- Select the Step button in the HS electrical test tool to acquire the waveform as shown in the following figure:

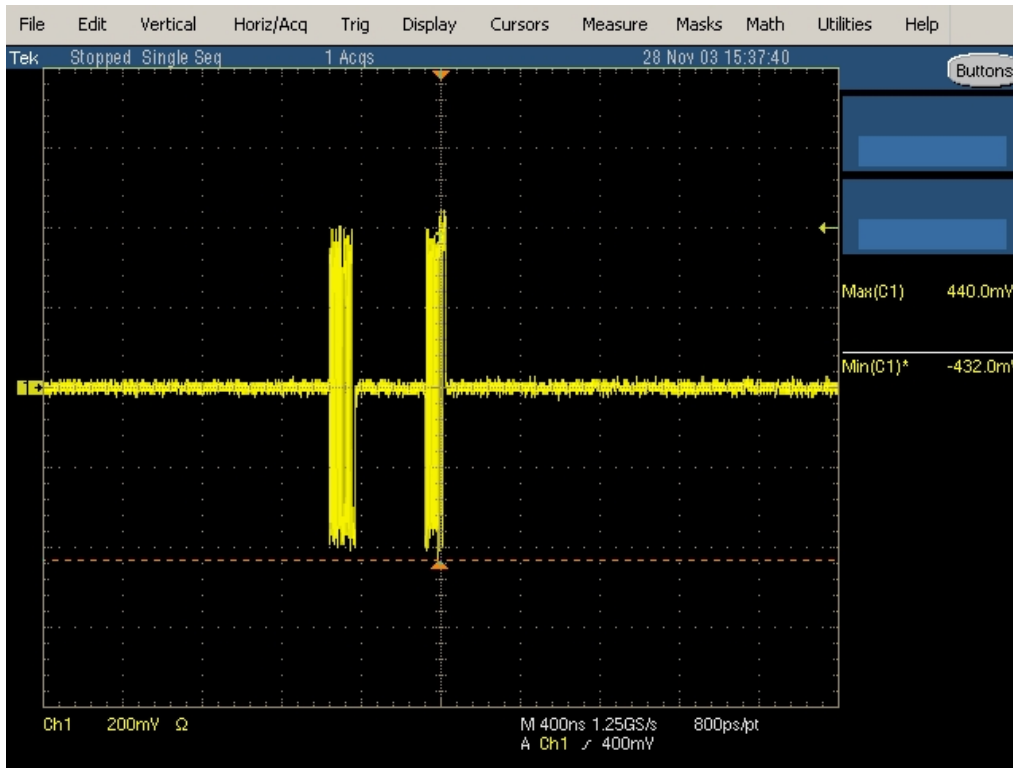

Figure 74: Acquiring the waveform

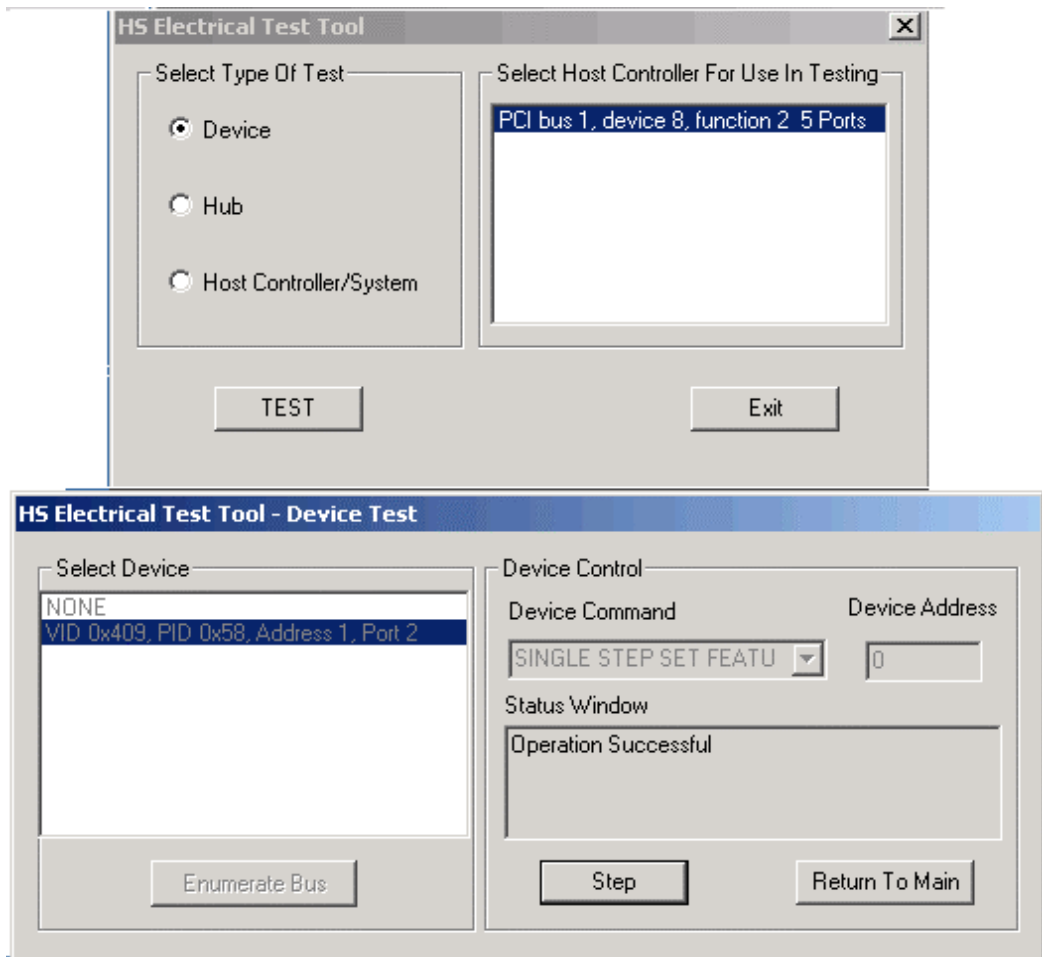

Figure 75: Setting the trigger level

- The application measures the number of bits (88-192) between the packets

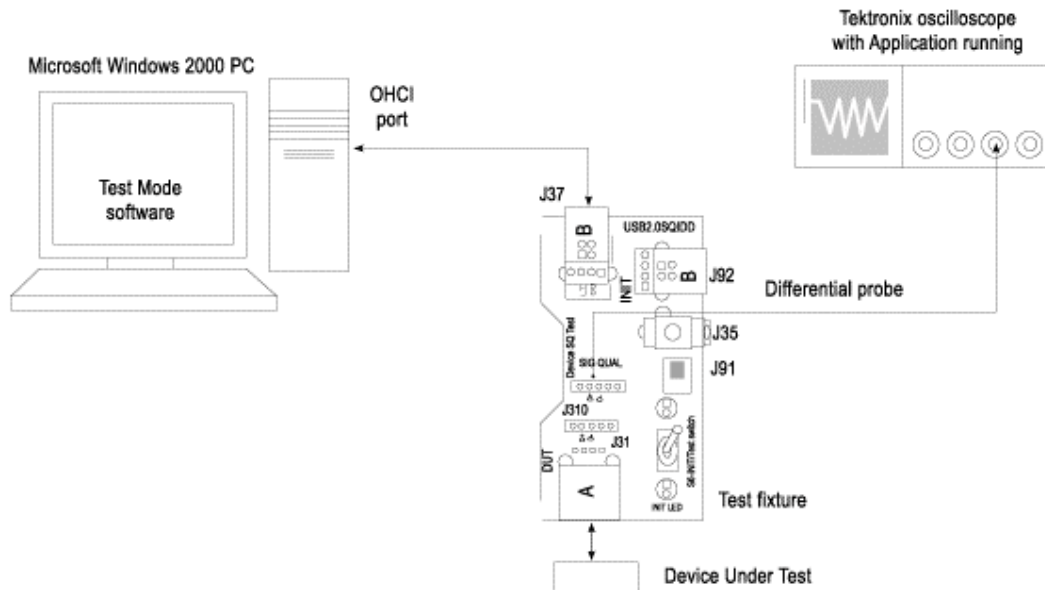

Figure 76: Equipment setup for Packet Parameter measurement

Selecting and Configuring Measurement-Packet Parameter Measurement

Follow these steps to select measurements for Packet Parameter measurement:

1. From the application menu, select Measurement> Select> High speed tab.
2. Select the More button to display the following tests:
 - Receiver Sensitivity
 - Suspend
 - Reset from High Speed
 - Packet Parameter
 - Chirp
 - Resume
 - Reset Suspend
3. Select Packet Parameter measurement.

Configuring the Measurement

Follow the steps to configure the selected measurements:

1. From the application menu, select Measurement> Configure> Configure tab.
2. Configure the following options:

Table 19. Configuring measurements

Option	Set to
Select DUT	Host, Device

3. Configure the following options:

Table 20. Configuring options

Option	Set to
Host	EL_21, EL_23, EL_25 EL_22,EL_55
Device	EL_21, EL_22, EL_25 EL_22
Source	Ch1-Ch4, Ref1-Ref4

4. Select  to acquire the data.

Viewing Results-Packet Parameter Measurement

To view the results of the tests, follow these steps:

1. Run the application and from the application menu, select Results> Summary.

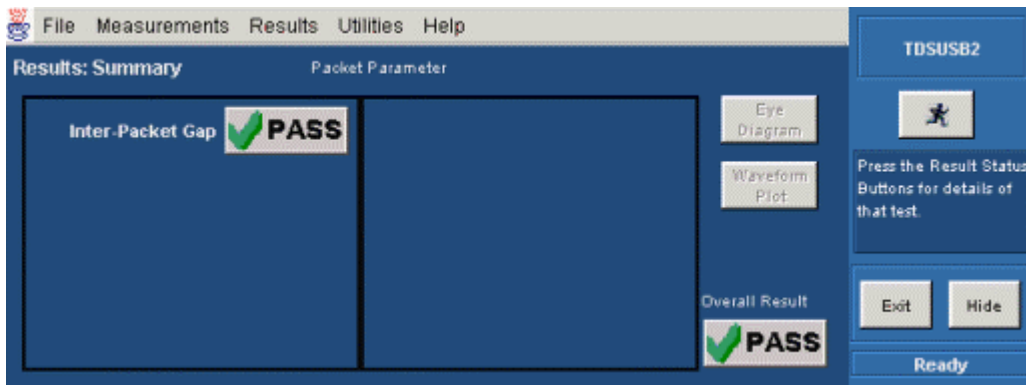

Figure 77: Results summary of the Packet Parameter Measurement

2. Click any of the test result buttons to get the details of that test.

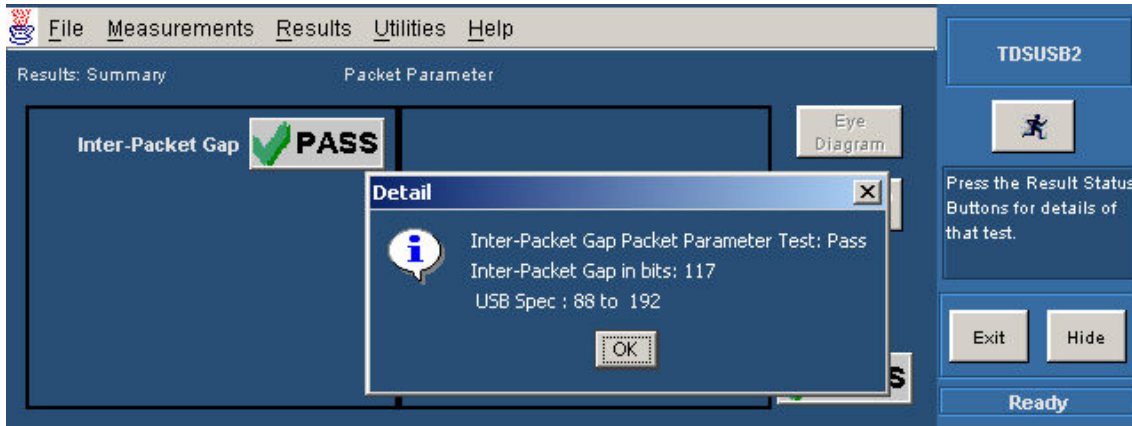

Figure 78: Results summary and details

3. From the application menu, select Results> Details.

Generating Reports-Packet Parameter Measurement

To generate reports of the test results, follow these steps:

1. From the application menu, select Utilities> Report Generator.
2. Select any one of the Report formats: Tektronix Specific, Plug-Fest Specific, or CSV format.

Measurement Name	Unit	Measurement Val	Usb Limits	Status
Sync Field	bits	32	32	Pass
EOP Width in bits	bits	7.75556	7.5 to 8.5	Pass
Inter-Packet Gap in bits	bits	117.88	88 to 192	Pass

Additional Information : EOP Width in time is 16.15742nS

Figure 79: Report in CSV format

Packet Parameter Test Results for dev_id

For details on test setup, methodology, and performance criteria, please consult the power consumption requirements test description at the http://www.usb.org/developers/compliance_testing.html USB-IF Compliance Program web page.

Required Tests

- Packet Parameter Result Pass
- Sync Field in bits: 32 and USB Limits: 32
- EOP Width in bits: 7.755560 and USB Limits: 7.5 to 8.5
- Inter-Packet Gap in bits: 117 and USB Limits: 88 and 192

Additional Information : EOP Width in time is 16.15742nS

TDSUSB2 software version: 1.3

Figure 80: Packet Parameter test results

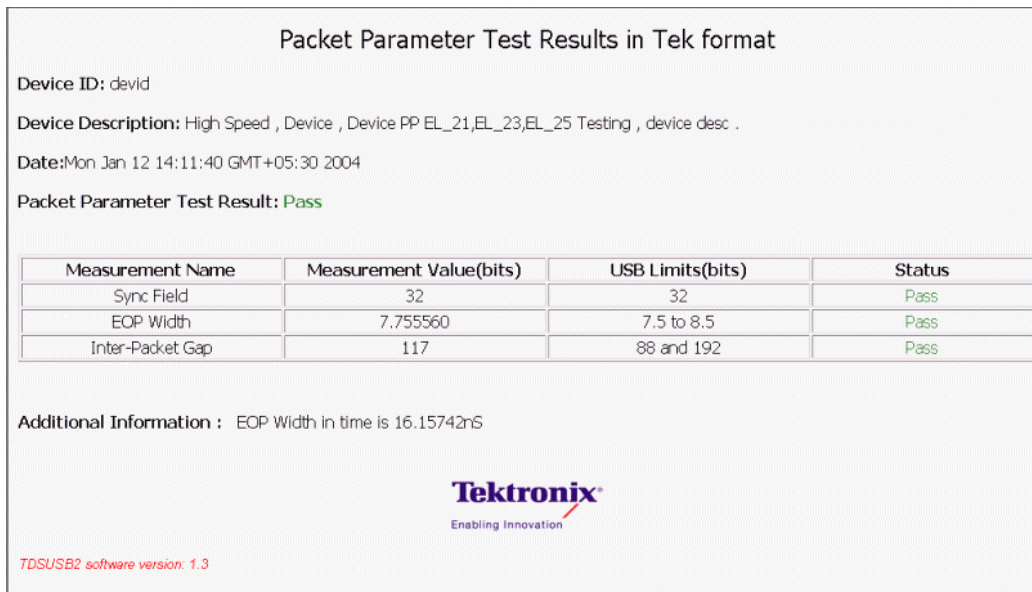

Figure 81: Report in Tektronix Specific format

3. Select the manual generation mode.
4. Select the Generate button to display and view the selected report format.

Note: You can view the Plug-Fest specific report format as HTML pages and the .csv format in Microsoft Excel.

Resume Measurement

Specifying the Equipment-Resume Measurement

The following equipment is needed for Resume measurement:

- Tektronix digital oscilloscope
- TDSUSB2 application
- TDSUSBF compliance test fixture
- Two P6245 or TAP1500 single-ended probes

Typical Equipment Setup-Resume Measurement

To set up the Device SQ in the test fixture for the Resume test, follow these steps:

1. Set the S5 switch to the Init position.
2. Use a standard length of the USB cable with an A plug on one end and a B plug on the other end. Connect one end of the cable to the B receptacle socket connector on the Init port of the Device SQ section and the other end to the host port A socket.
3. Connect the A receptacle from the Device SQ test port to the unit under test (device).
4. Connect the single-ended probes of the oscilloscope to the D+ and D- pins.
5. Select the Resume measurement in the application, configure its options and select the Run button to run the application.
6. Select OK after acquiring a waveform. Verify that it is a correct waveform.

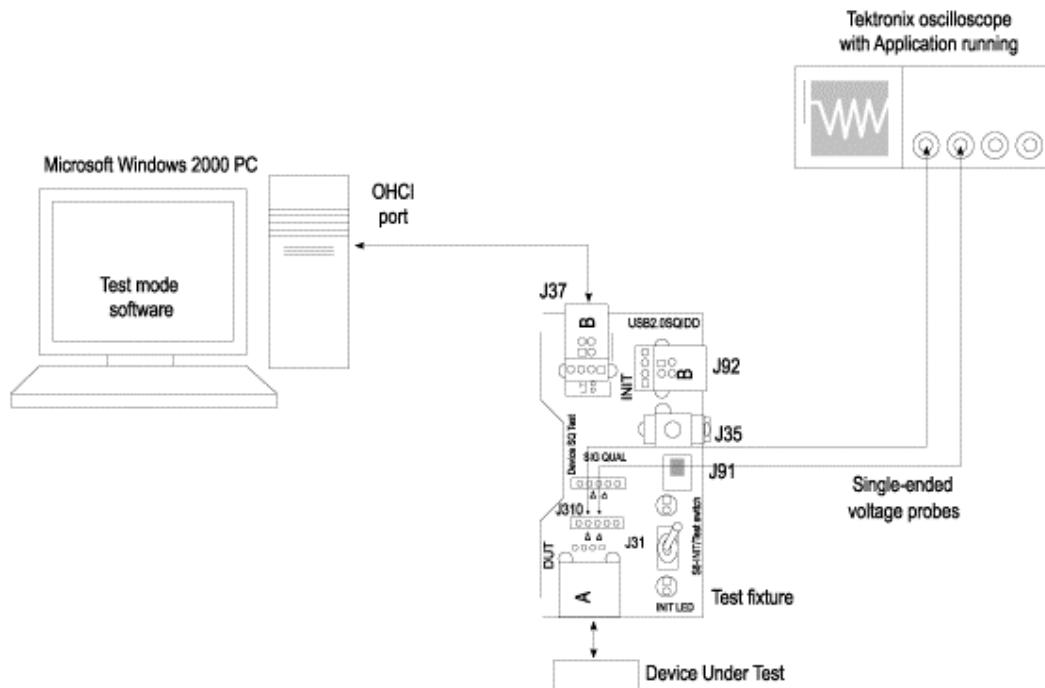

Figure 82: Equipment setup for Resume Measurement

Selecting and Configuring Measurement-Resume

Follow these steps to select measurements for the Resume measurement:

1. From the application menu, select Measurement> Select> High speed (tab).
2. Select the More button to display the following tests:
 - Receiver Sensitivity
 - Suspend
 - Reset from High Speed
 - Packet Parameter
 - Chirp
 - Resume
 - Reset Suspend
3. Select the Resume measurement.

Configuring the Measurement

Follow the steps to configure the selected measurements:

1. From the application menu, select Measurement> Configure> Configure tab.
2. Configure the following options:

Table 21. Configuring measurements

Option	Set to
Signal Direction	Upstream, Downstream
Source	D+ Ch1-Ch4, Ref1-Ref4 D- Ch1-Ch4, Ref1-Ref4

3. Select  to acquire the data.

Viewing Results-Resume Measurement

To view the results of the tests, follow these steps:

1. Run the application and from the application menu, and select Results> Summary.

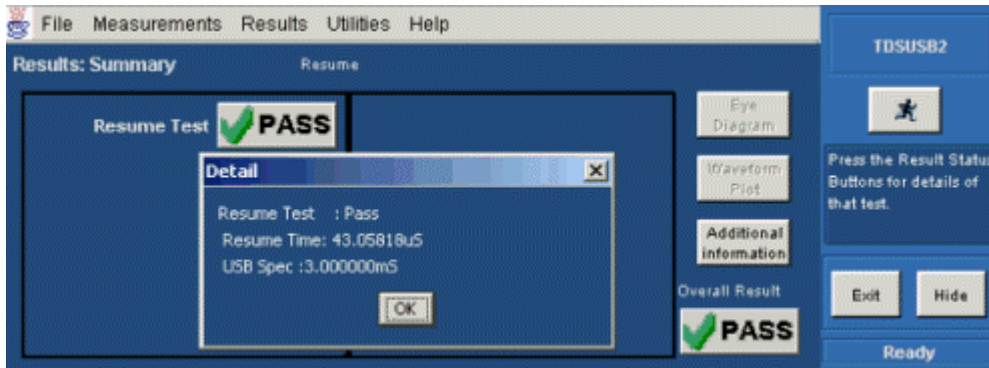

Figure 83: Results summary for Resume Measurement

2. Click any of the test result buttons to get the details of that test.
3. From the application menu, select Results> Details.

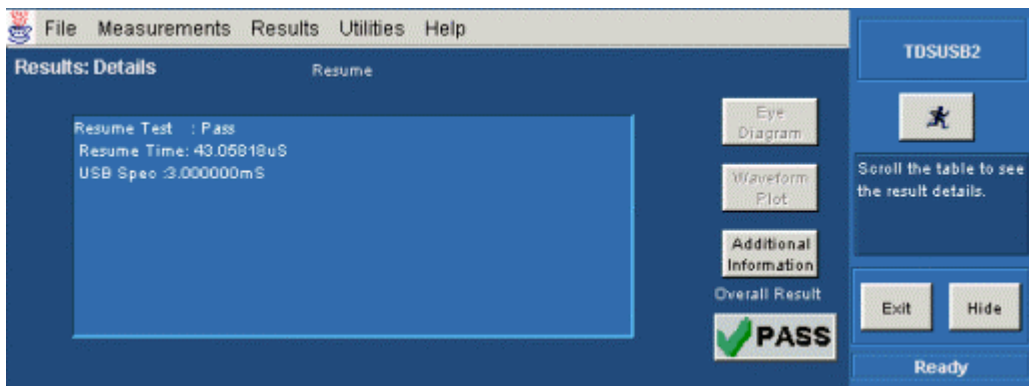

Figure 84: Results details for Resume Measurement

Generating Reports-Resume Measurement

To generate reports of the test results, follow these steps:

1. From the application menu, select Utilities> Report Generator.
2. Select any one of the Report formats: Tektronix Specific, Plug-Fest Specific, or CSV format.

	A	B	C	D	E	F	G	H	I	J	K	L	M	N	O
1			Packet Parameter Report												
2			USB2.0 Test PackageVersion 1.3												
3			Device ID fsfe_001												
4			Device Des High Spee Dummy Device												
5			Time Stamp Wed Jan 07 15:34:48 GMT+05:30 2004												
6															
7		Measurem Unit	Measurem Usb Limits	Status											
8		Sync Fieldbits	-	32	Fail										
9		EOP Widthbits	7.843719	7.5 to 8.5	Pass										
10		Inter-Packbits	170.88	to 192	Pass										
11															
12															
13															
14															
15															
16															
17															
18															
19															
20															
21															
22															
23															
24															
25															
26															
27															
28															
29															
30															
31															
32															
33															
34															
35															

Figure 85: Report for Resume Measurement in CSV format

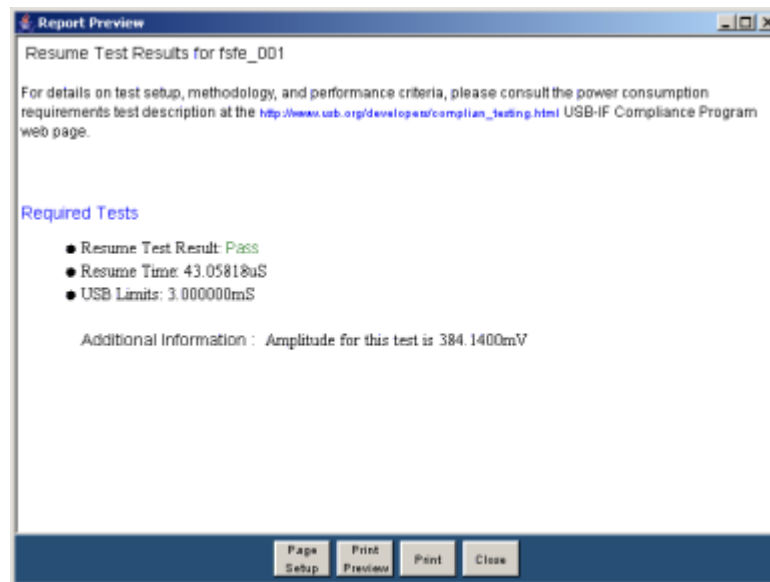

Figure 86: Report in Plug-Fest format for Resume Measurement

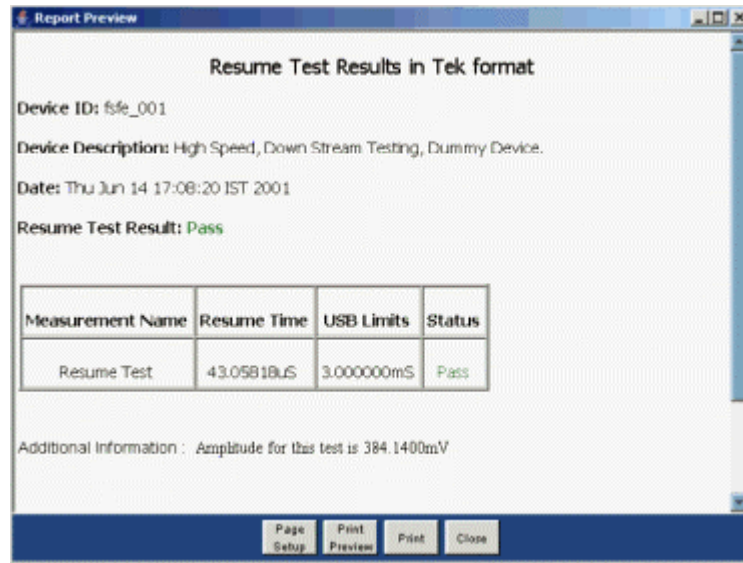

Figure 87: Report in Tektronix-Specific format for Resume Measurement

3. Select the manual generation mode.
4. Select the Generate button to display and view the selected report format.

Note: You can view the Plug-Fest specific report format as HTML pages and the .csv format in Microsoft Excel.

Reset from Suspend Measurement

Specifying the Equipment-Reset from Suspend Measurement

The following equipment is needed for Reset from Suspend measurement:

- Tektronix digital oscilloscope
- TDSUSB2 application
- TDSUSBF compliance test fixture
- Two P6245 or TAP1500 single-ended probes

Typical Equipment Setup-Reset from Suspend Measurement

To set up the Device SQ in the test fixture for the Reset from Suspend test, follow these steps:

1. Set the S6 switch to the Init position.
2. Use a standard length of the USB cable with an A plug on one end and a B plug at the other end.
3. Connect one end of the cable to the B receptacle socket connector on the Init port of the Device SQ section and the other end to the host port A socket.
4. Connect the A receptacle from the Device SQ test port to the unit under test (device).
5. Connect the single-ended probes of the oscilloscope to the D+ and D- pins.
6. Select the Reset from Suspend measurement from the application, configure its options, and select the Run button to run the application.
7. Select OK after acquiring a waveform. Verify that it is a correct waveform.

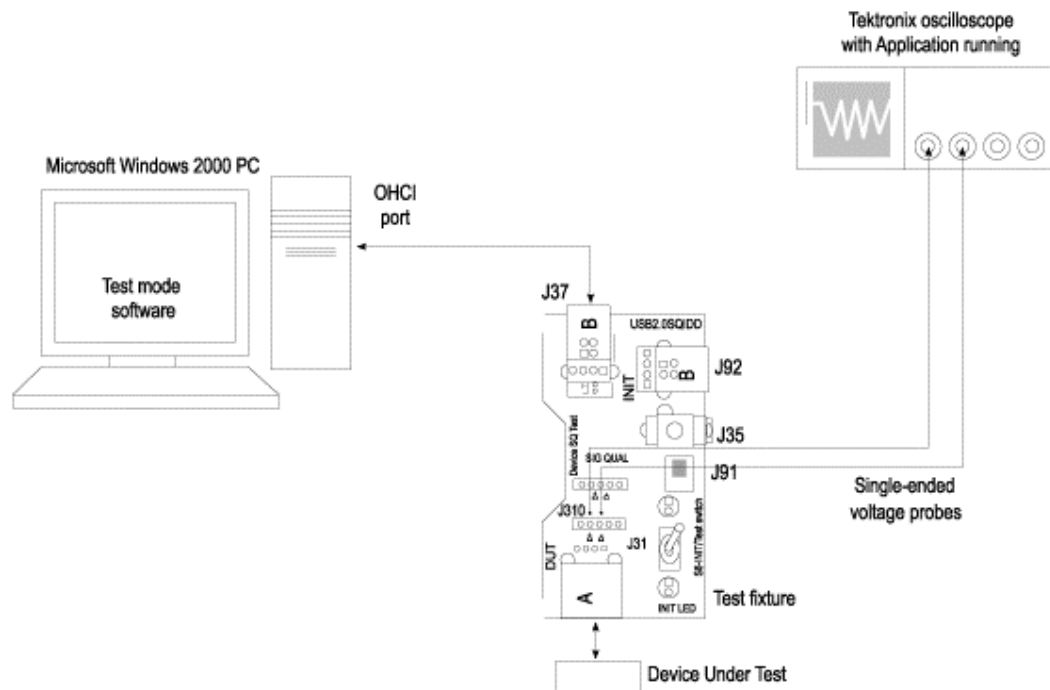

Figure 88: Equipment for Reset from Suspend Measurement

Selecting and Configuring Measurement-Reset from Suspend Measurement

Follow these steps to select measurements for Reset from Suspend measurement:

1. From the application menu, select Measurement> Select> High Speed tab.
2. Select the More button to display the following tests:
 - Receiver Sensitivity
 - Suspend
 - Reset High Speed
 - Packet Parameter
 - Chirp
 - Resume
 - Reset From Suspend
3. Select the Reset from Suspend measurement.

Configuring the Measurement

Follow the steps to configure the selected measurements:

1. From the application menu, select Measurement> Configure> Configure tab.
2. Configure the following options:

Table 22. Configuring measurements

Option	Set to
Signal Direction	Upstream
Source	D+ Ch1-Ch4, Ref1-Ref4 D- Ch1-Ch4, Ref1-Ref4

3. Select  to acquire the data.

Viewing Results-Reset from Suspend Measurement

To view the results of the tests, follow these steps:

1. Run the application and from the application menu, and select Results> Summary.

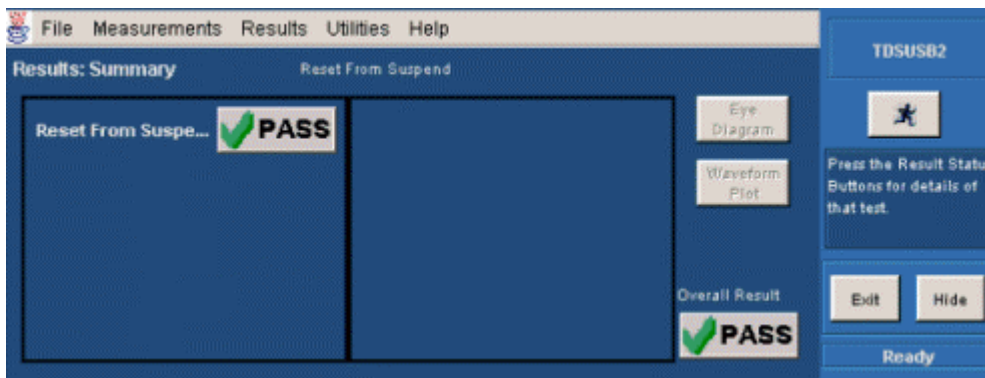

Figure 89: Results summary for Reset from Suspend Measurement

2. Click any of the test result buttons to get the details of that test.

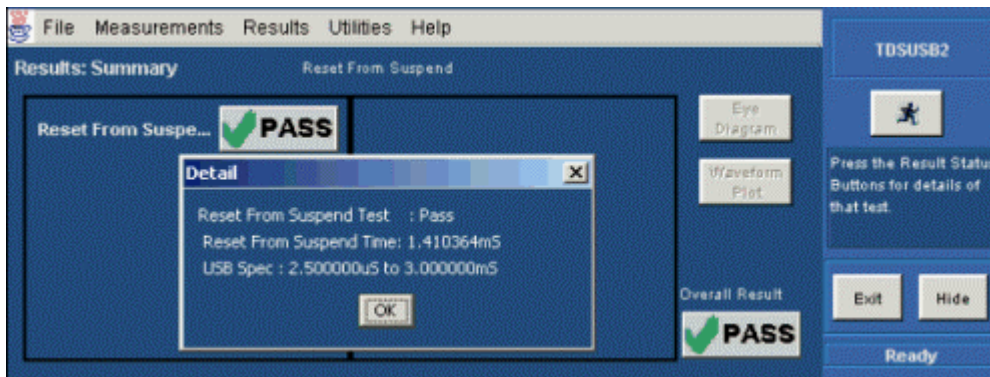

Figure 90: Results summary for Reset from Suspend Measurement

3. From the application menu, select Results> Details.

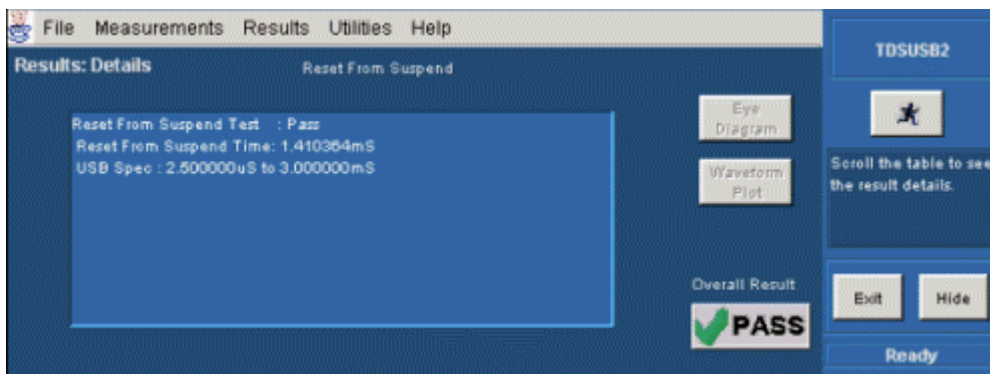

Figure 91: Results details for Reset from Suspend Measurement

Generating Reports-Reset from Suspend Measurement

To generate reports of the test results, follow these steps:

1. From the application menu, select Utilities> Report Generator.
2. Select any one of the Report formats: Tektronix Specific, Plug-Fest Specific, or CSV format.

	A	B	C	D	E	F	G	H
1			Reset from Suspend Report					
2			USB2.0 Test PackageVersion 1.6.0					
3			Device ID fsfe_001					
4			Device Description High Speed Dummy Device					
5			Time Stamp Thu Jun 14 17:22:59 IST 2001					
6								
7			Measurement Unit Reset from Resume Time USB Limits Status					
8			Reset From Suspend Test S 1.410364mS 2.500000uS to 3.000000mS Pass					
9								
10								
11								
12								
13								
14								
15								
16								
17								
18								
19								
20								
21								
22								
23								
24								
25								
26								
27								
28								
29								
30								
31								
32								
33								
34								
35								

Figure 92: Report in CSV format for Reset from Suspend Measurement

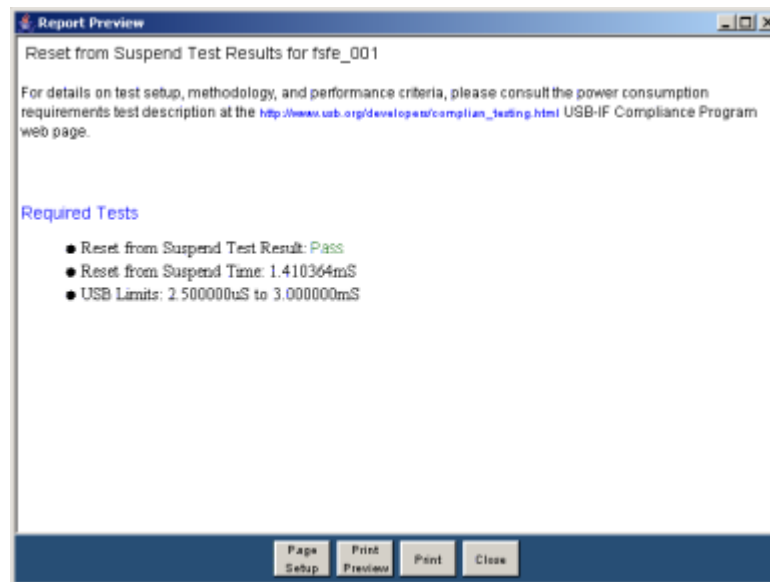

Figure 93: Report in Plug-Fest format for Reset from Suspend Measurement

Measurement Name	Reset from Suspend Time	USB Limits	Status
Reset From Suspend Test	1.410364mS	2.500000uS to 3.000000mS	Pass

Figure 94: Report in Tektronix-Specific format for Reset from Suspend Measurement

3. Select the manual generation mode.
4. Select the Generate button to display and view the selected report format.

Note: You can view the Plug-Fest specific report format as HTML pages and the .csv format in Microsoft Excel.

Suspend Measurement

Specifying the Equipment-Suspend Measurement

The following equipment is needed for Suspend measurement:

- Tektronix digital oscilloscope
- TDSUSB2 application
- TDSUSBF compliance test fixture
- Two P6245 or TAP1500 single-ended probes

Typical Equipment Setup-Suspend Measurement

To set up the Device SQ in the test fixture for the Suspend test, follow these steps:

1. Set the S6 switch to the Init position.
2. Use a standard length of USB cable with an A plug on one end and a B plug on the other end.
3. Connect one end of the cable to the B receptacle socket connector on the Init port of the Device SQ section and the other end to the host port A socket.
4. Connect the A receptacle from the Device SQ test port to the unit under test (device).
5. Connect the single-ended probes of the oscilloscope to the D+ and D- pins.
6. Select the Suspend measurement, configure its options and select the Run button to run the application.
7. Select OK after acquiring a waveform. Verify that it is a correct waveform.

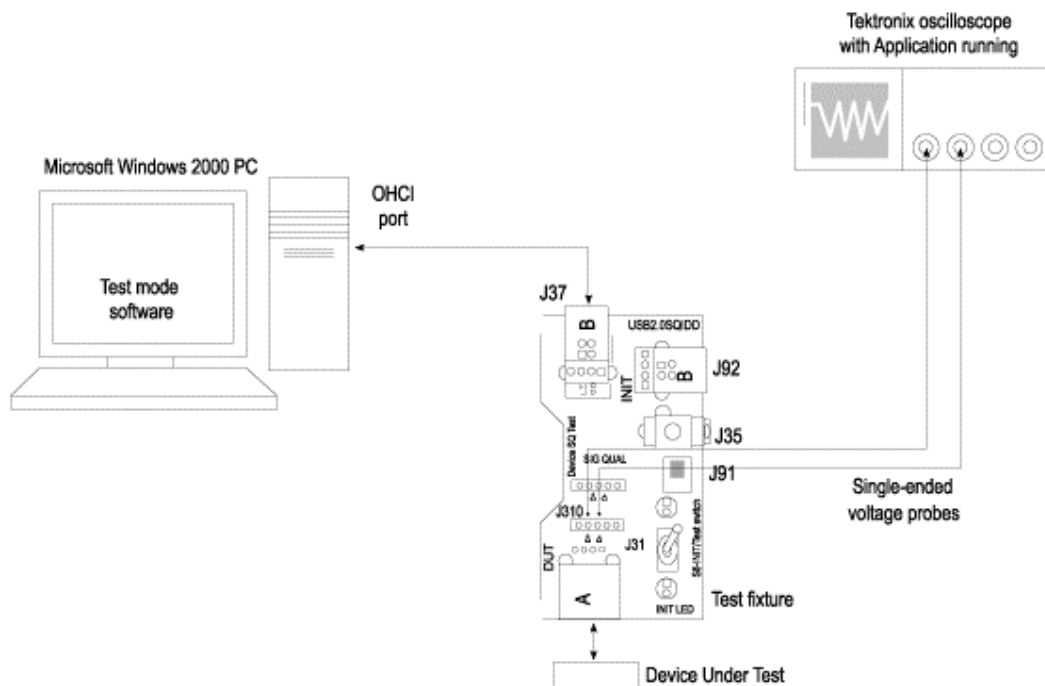

Figure 95: Equipment setup for Suspend Measurement

Selecting and Configuring Measurement-Suspend Measurement

Follow these steps to select measurements for Suspend measurement:

1. From the application menu, select Measurement> Select> High Speed tab.
2. Select the More button to display the following tests:
 - Receiver Sensitivity
 - Suspend
 - Reset High Speed
 - Packet Parameter
 - Chirp
 - Resume
 - Reset From Suspend
3. Select the Suspend measurement.

Configuring the Measurement

Follow the steps to configure the selected measurements:

1. From the application menu, select Measurement> Configure> Configure tab.
2. Configure the following signal direction options:

Table 23. Configuring measurements

Option	Set to
Signal Direction	Upstream, Downstream
Source	D+ Ch1-Ch4, Ref1-Ref4 D- Ch1-Ch4, Ref1-Ref4

3. Select  to acquire the data.

Viewing Results-Suspend Measurement

To view the results of the tests, follow these steps:

1. Run the application and from the application menu, and select Results> Summary.

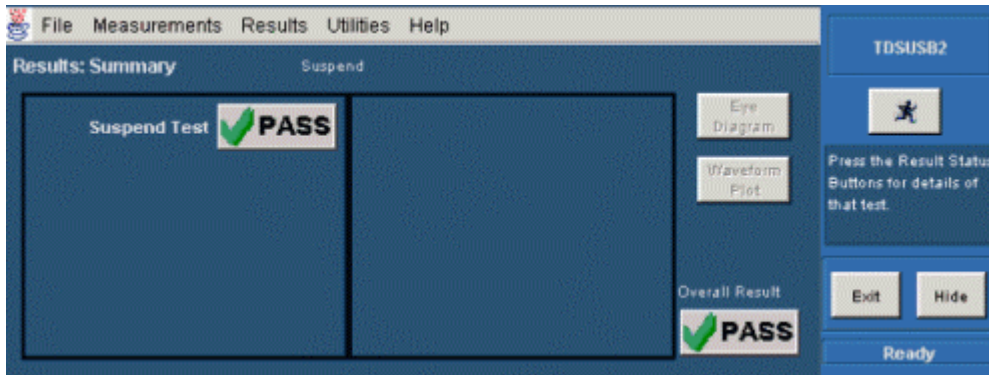

Figure 96: Results summary for Suspend Measurement

2. Click any of the test result buttons to get the details of that test.

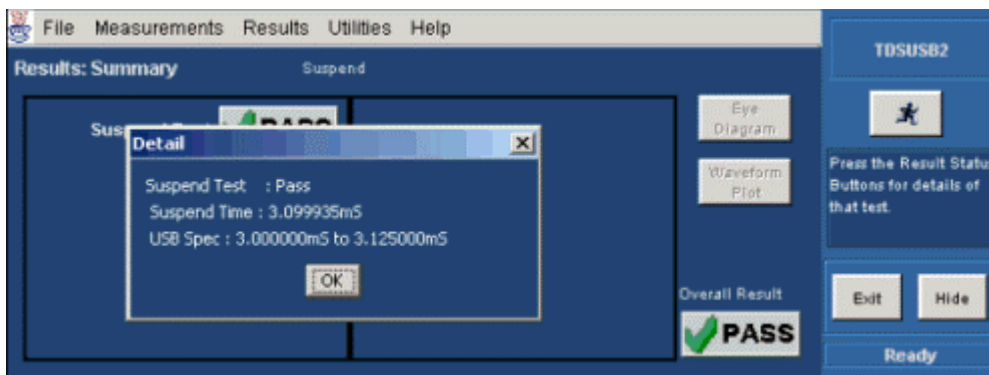

Figure 97: Results summary/details for Suspend Measurement

3. From the application menu, select Results> Details.

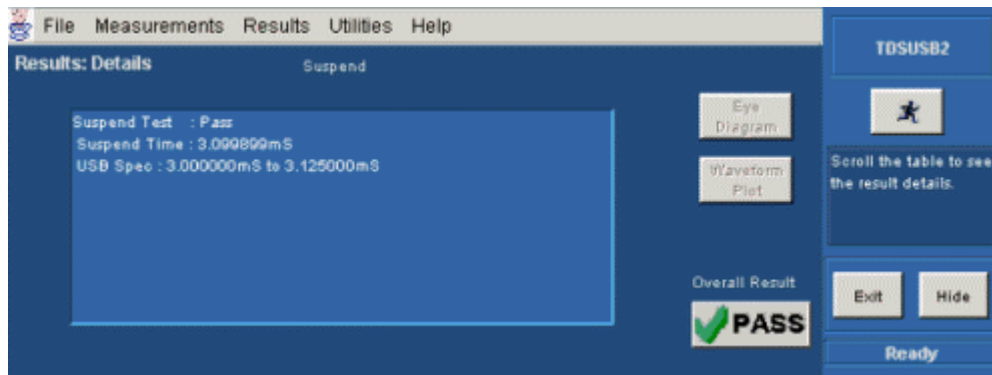

Figure 98: Results details for Suspend Measurement

Generating Reports-Suspend Measurement

To generate reports of the test results, follow these steps:

1. From the application menu, select Utilities> Report Generator.
2. Select any one of the Report formats: Tektronix Specific, Plug-Fest Specific, or CSV format.

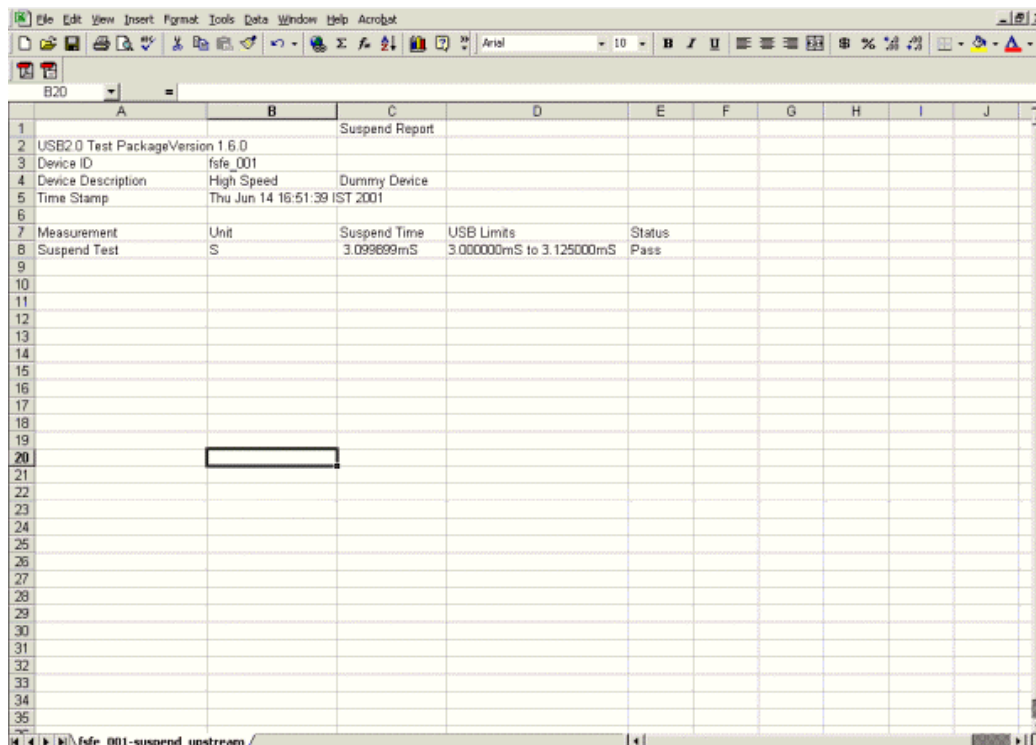

Figure 99: Report in CSV format for Suspend Measurement

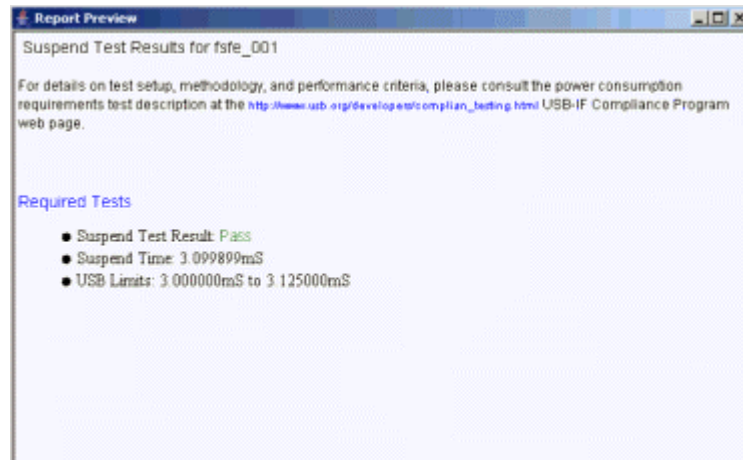

Figure 100: Report in Plug-Fest format for Suspend Measurement

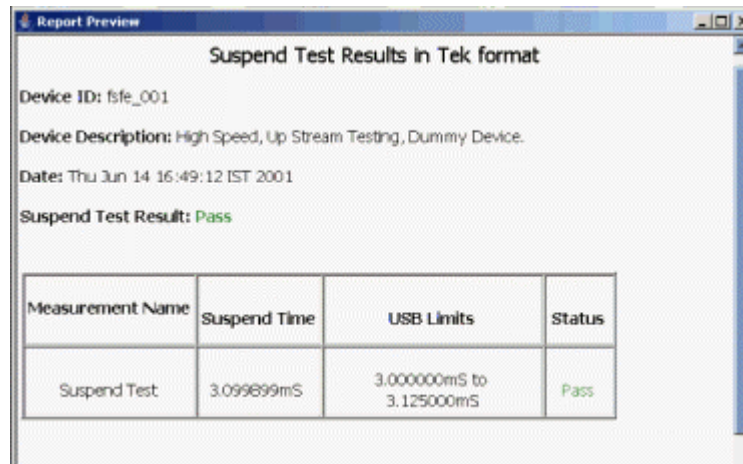

Figure 101: Report in Tektronix-Specific format for Suspend Measurement

3. Select the manual generation mode.
4. Select the Generate button to display and view the selected report format

Note: You can view the Plug-Fest specific report format as HTML pages and the .csv format in Microsoft Excel.

Reset from High Speed Measurement

Specifying the Equipment-Reset from High Speed Measurement

The following equipment is needed for Reset from High Speed measurement:

- Tektronix digital oscilloscope
- TDSUSB2 application
- TDSUSBF compliance test fixture
- Two P6245 or TAP1500 single-ended probes

Typical Equipment Setup-Reset from High Speed Measurement

To set up the Device SQ in the test fixture for the Reset from High Speed test, follow these steps:

1. Set the S6 switch to the Init position.
2. Use a standard length of the USB cable with an A plug on one end and a B plug on the other end.
3. Connect one end of the cable to the B receptacle socket connector on the Init port of the Device SQ section and the other end to the host port A socket.
4. Connect the A receptacle from the Device SQ test port to the unit under test (device).
5. Connect the single-ended probes of the oscilloscope to the D+ and D- pins.
6. Select the Reset from High Speed from the application, configure its options and select the Run button to run the application.
7. Select OK after acquiring a waveform. Verify that it is a correct waveform.

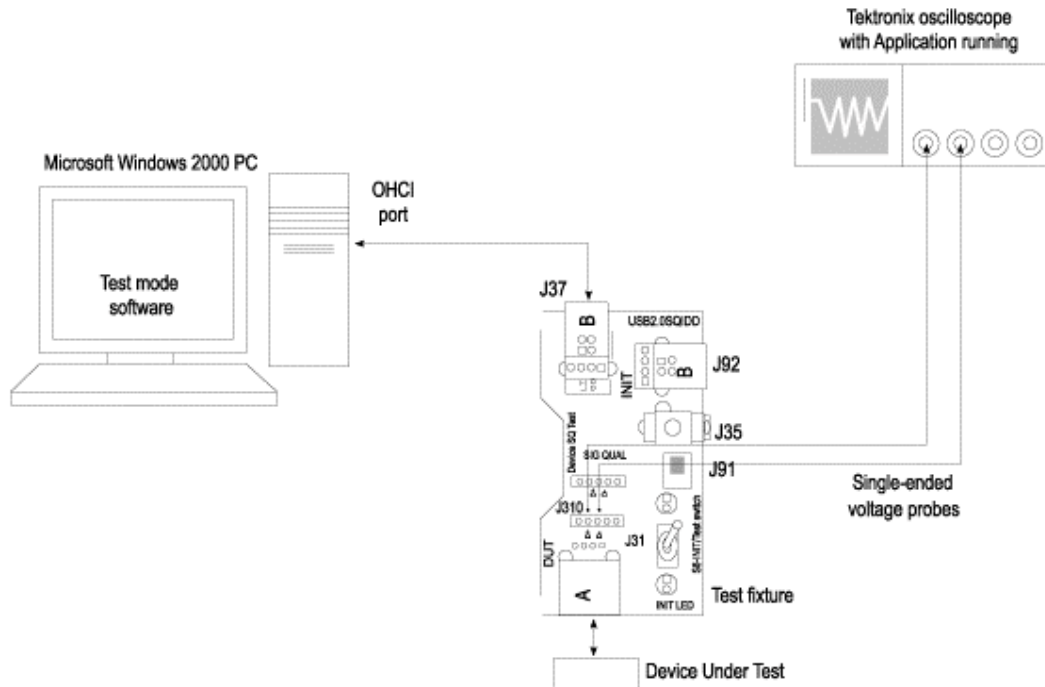

Figure 102: Equipment setup in Reset from High Speed Measurement

Selecting and Configuring Measurement-Reset from High Speed Measurement

Follow these steps to select measurements for Reset from High Speed measurement:

1. From the application menu, select Measurement> Select> High Speed tab.
2. Select the More button to display the following tests:
 - Receiver Sensitivity
 - Suspend
 - Reset High Speed
 - Packet Parameter
 - Chirp
 - Resume
 - Reset From Suspend
3. Select the Reset from High Speed measurement.

Configuring the Measurement

Follow these steps to configure the selected measurements:

1. From the application menu, select Measurement> Configure> Configure tab.
2. Configure the following options:

Table 24. Configuring measurements

Option	Set to
Signal Direction	Upstream
Source	D+ Ch1-Ch4, Ref1-Ref4 D- Ch1-Ch4, Ref1-Ref4

3. Select  to acquire the data.

Viewing Results-Reset from High Speed Measurement

To view the results of the tests, follow these steps:

1. Run the application and from the application menu, and select Results> Summary.

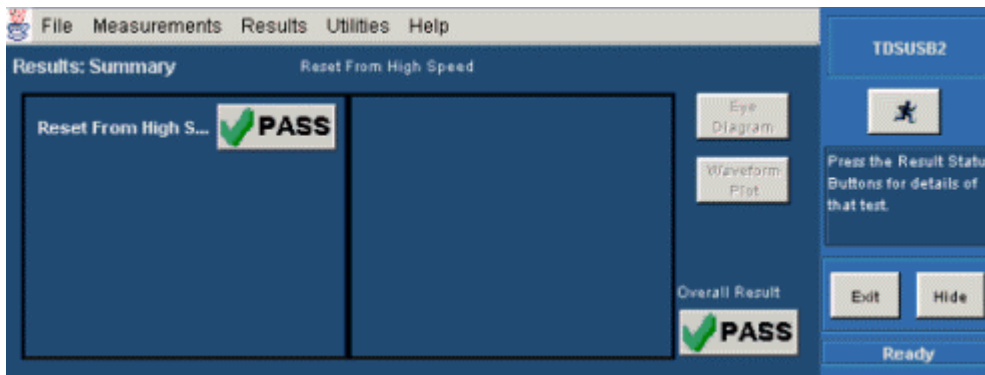

Figure 103: Results summary for Reset from High Speed Measurement

2. Click any of the test result buttons to get the details of that test.

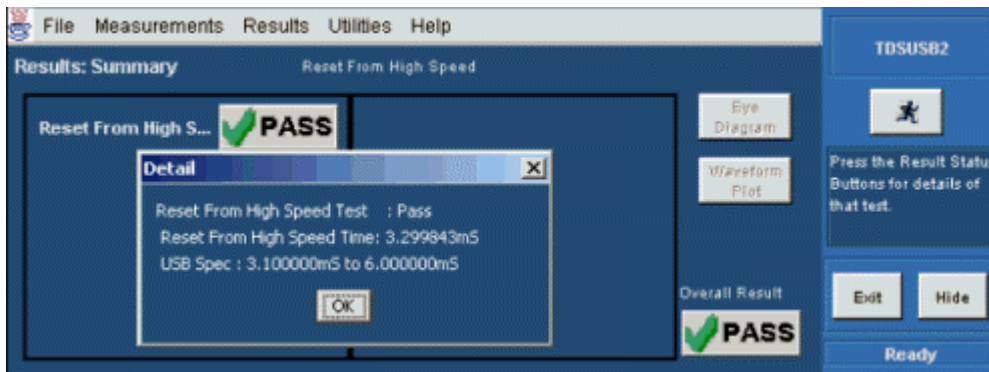

Figure 104: Results summary/detail for Reset from High Speed Measurement

3. From the application menu, select Results> Details.

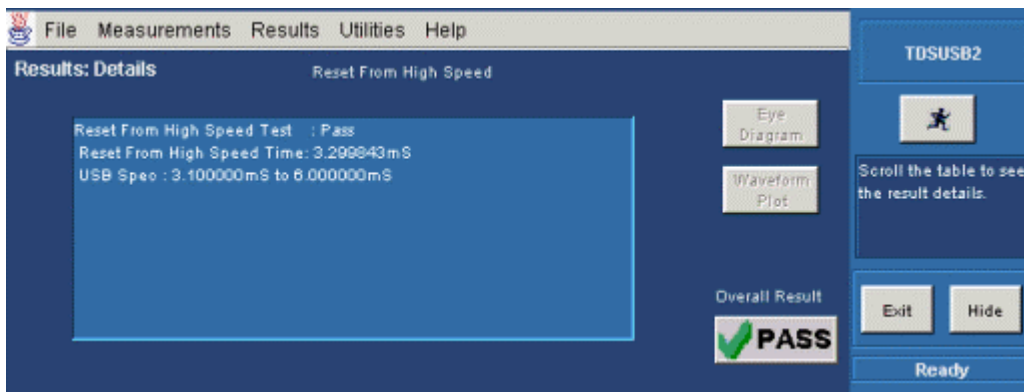

Figure 105: Results details for Reset from High Speed Measurement

Generating Reports-Reset from High Speed Measurement

To generate reports of the test results, follow these steps:

1. From the application menu, select Utilities> Report Generator.
2. Select any one of the Report formats: Tektronix Specific, Plug-Fest Specific or CSV format.

Reset From High Speed Report						
1	Reset From High Speed Report					
2	USB2.0 Test Package/Version 1.6.0					
3	Device ID	fsfe_001				
4	Device Description	High Speed	Dummy Device			
5	Time Stamp	Thu Jun 14 17:18:13 IST 2001				
6	Measurement	Unit	Reset From High Speed	USB Limits	Status	
8	Reset From High Speed Test	S	3.299643mS	3.100000mS to 6.000000mS	Pass	
10						
11						
12						
13						
14						
15						
16						
17						
18						
19						
20						
21						
22						
23						
24						
25						
26						
27						
28						
29						
30						
31						
32						
33						
34						
35						

Figure 106: Report in CSV format for Reset from High Speed Measurement

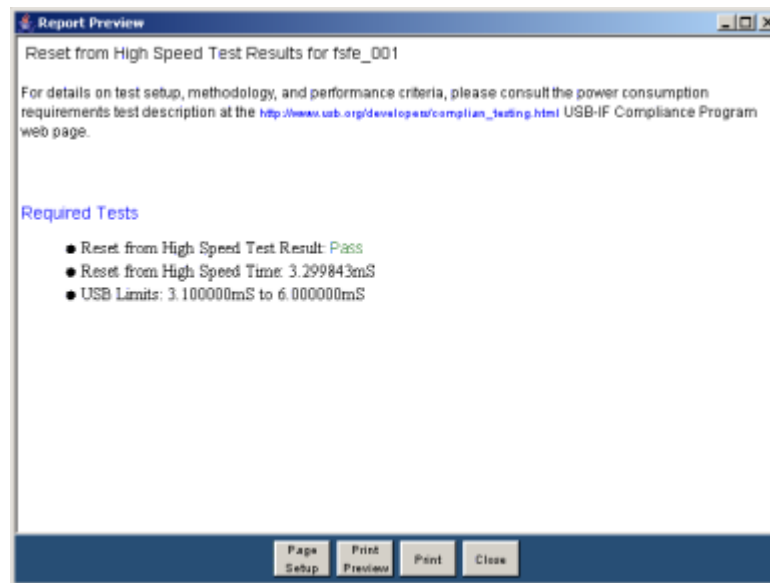

Figure 107: Report in Plug-Fest format for Reset from High Speed Measurement

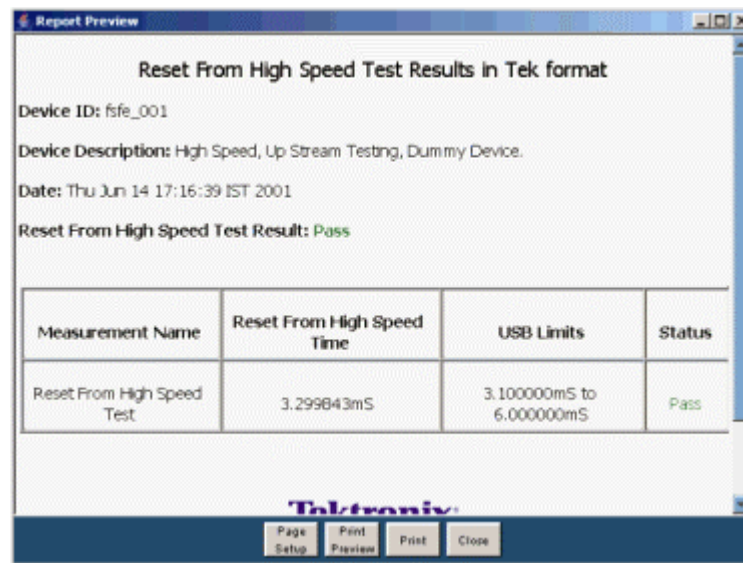

Figure 108: Report in Tektronix-Specific format for Reset from High Speed Measurement

3. Select the manual generation mode.
4. Select the Generate button to display and view the selected report format.

Note: You can view the Plug-Fest specific report format as HTML pages and the .csv format in Microsoft Excel.

Chirp Measurement

Specifying the Equipment-Chirp

The following equipment is needed to test Chirp measurement:

- Tektronix digital oscilloscope
- TDSUSB2 application
- TDSUSBF compliance test fixture
- Two P6245 or TAP1500 single-ended probes

Typical Equipment Setup-Chirp

The section used for this device test is Device SQ in the test fixture. To set up the equipment for the Chirp test, follow these steps:

1. Set the S6 switch to the Init position.
2. Use a standard length of the USB cable with an A plug on one end and a B plug on the other end.
3. Connect one end of the cable to the B receptacle socket connector on the Init port of Device SQ section and the other end to the host port A socket.
4. Connect the A receptacle from the Device SQ test port to the unit under test (device).
5. Connect the single-ended probes of the oscilloscope to the D+ and D- pins.
6. Select the measurement and select the  button to run the application.
7. Run the HS Electrical Test Tool on the connected host. Enumerate the unit under test (device) and observe the chirp signal on the oscilloscope. Rather than enumerating the device, an alternative method to generate the chirp signal is to disconnect and reconnect the unit under test (device) to the port.

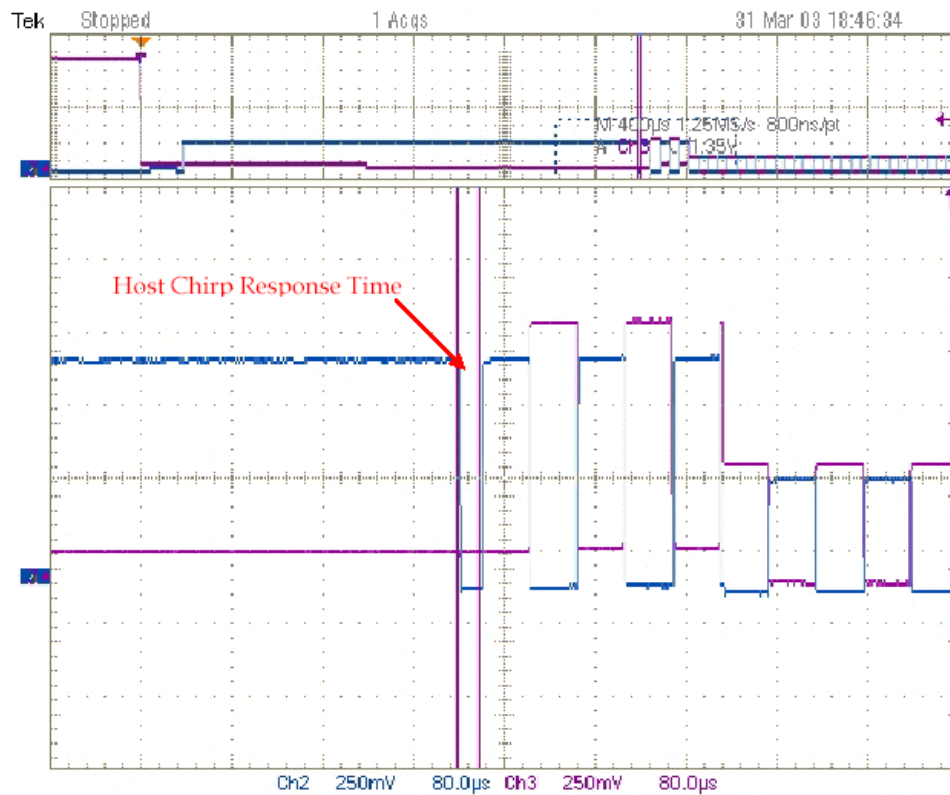

Figure 109: Chimp signal

8. Select OK after acquiring a waveform. Verify that it is a correct waveform.

Note: To avoid false triggering for the chimp signals while operating the test fixture, it is recommended that you place the switch in the Init position and connect the unit under test. This disables the switch bounce to the trigger.

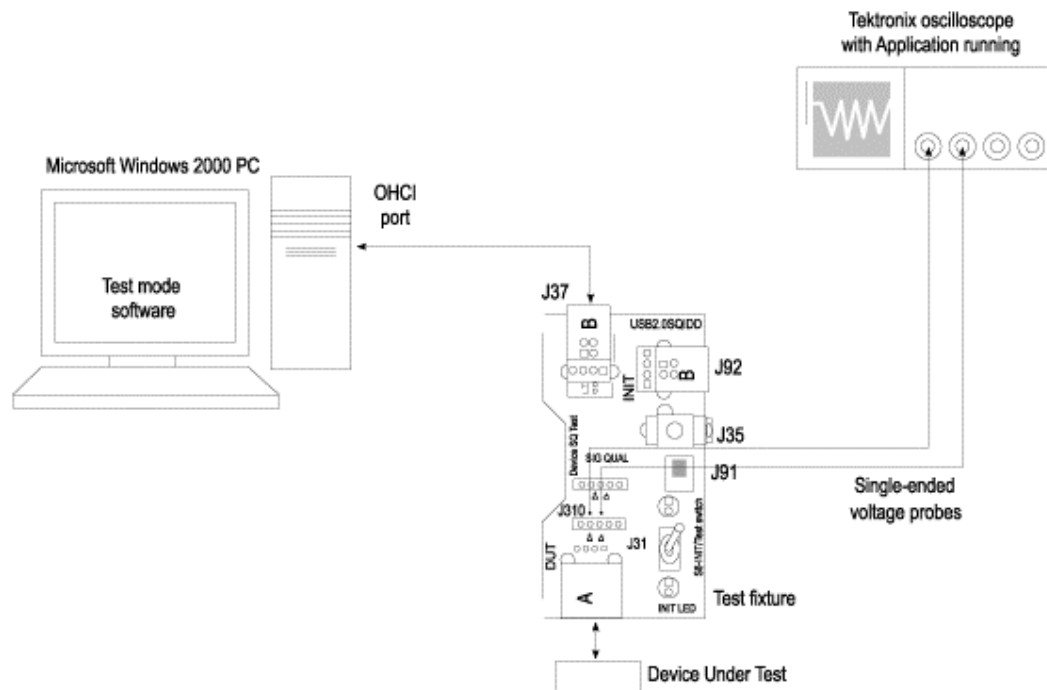

Figure 110: Equipment setup for Chirp Measurement

Selecting and Configuring Measurement-Chirp

Follow these steps to select measurements for Chirp measurement:

1. From the application menu, select Measurement> Select> High Speed tab.
2. Select the More button to display the following tests:
 - Receiver Sensitivity
 - Suspend
 - Reset from High Speed
 - Packet Parameter
 - Chirp
 - Resume
 - Reset Suspend
3. Select Chirp measurement.

Configuring the Measurement

Follow the steps to configure the selected measurements:

1. From the application menu, select Measurement> Configure> Configure tab.
2. Configure the following options:

Table 25. Configuring measurements

Option	Set to
Select DUT	Host, Device
Host	EL_33, EL_34 EL_35
Device	EL_28, EL_29, EL_31
Source	Ch1-Ch4, Ref1-Ref4

3. Select  to acquire the data.

Viewing Results-Chirp

To view the results of the tests, follow these steps:

1. Run the application and from the application menu, and select Results> Summary. The following figures show the result of a Chirp Device measurement:

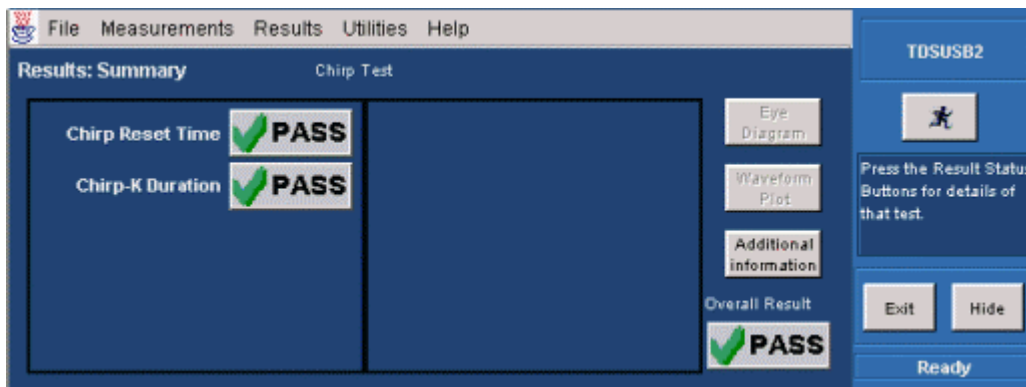

Figure 111: Results summary for Chirp Measurement

2. Click any of the test result buttons to get the details of that test.

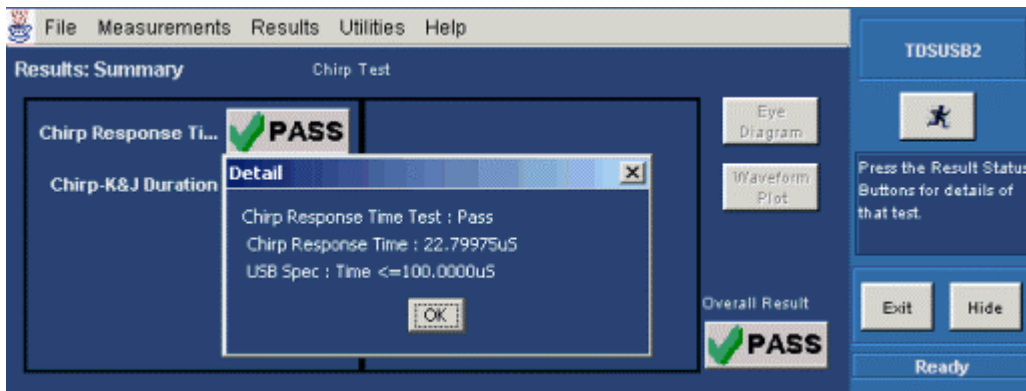

Figure 112: Results summary/details for Chirp Measurement

3. From the application menu, select Results> Details.

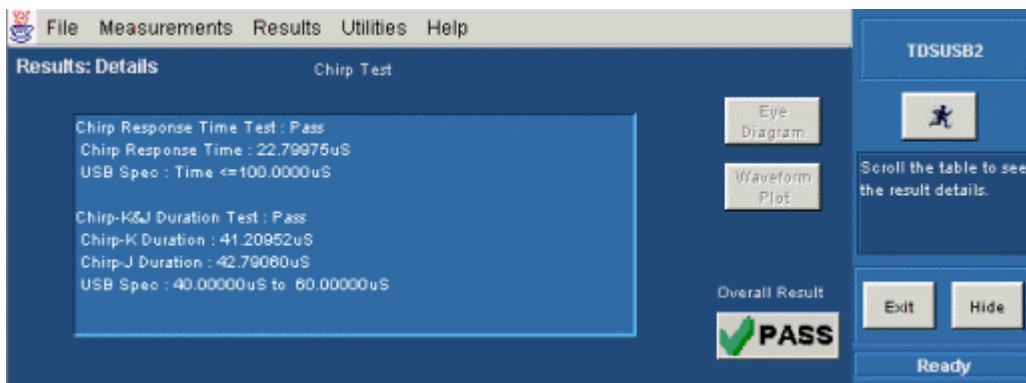

Figure 113: Results details for Chirp Measurement

4. Click here to view the results of the Chirp Host measurement.

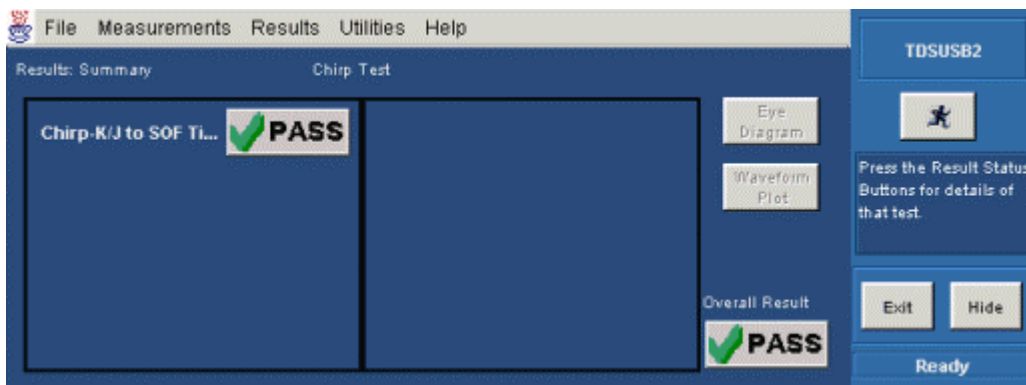

Figure 114: Results summary for Chirp Host Measurement

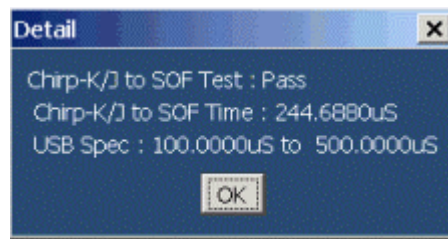

Figure 115: Results detail for Chirp Host Measurement

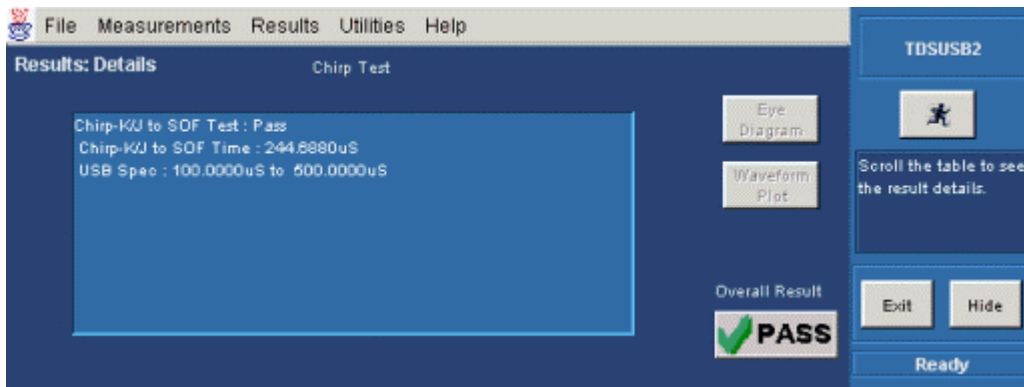

Figure 116: Results details for Chirp Host Measurement

Generating Reports-Chirp

To generate reports of the test results, follow these steps:

1. From the application menu, select Utilities> Report Generator.
2. Select any one of the Report formats: Tektronix Specific, Plug-Fest Specific or CSV format.

	A	B	C	D	E	F	G	H
1			Chirp Report					
2	USB2.0 Test Package Version 1.6.0							
3	Device ID	fsfe_001						
4	Device Description	High Speed	Dummy Device					
5	Time Stamp	Thu Jun 21 11:47:03 IST 2001						
6								
7	Measurement Name	Unit	Measurement Value	Usb Limits	Status			
8	Chirp Response Time	S	22.79975uS	Time <=100.0000uS	Pass			
9	Chirp-K&J Duration	S	41.20952uS & 42.79060uS	40.00000uS to 60.00000uS	Pass			
10								
11								
12								
13								
14								
15								
16								
17								
18								
19								
20								
21								
22								
23								
24								
25								
26								
27								
28								
29								
30								
31								
32								
33								
34								
35								
36								

Figure 117: Report in SCV format for Chirp Measurement

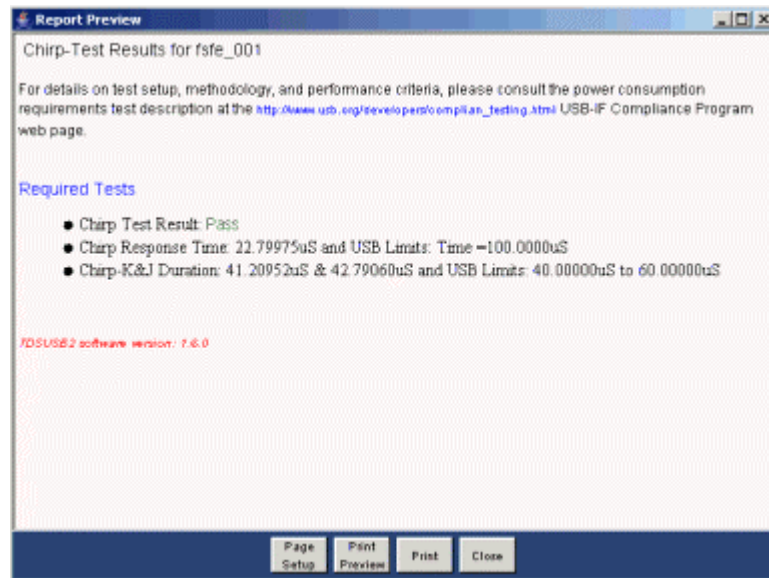

Figure 118: Report in Plug-Fest format for Chirp Measurement

Report Preview

Chirp-Test Results in Tek format

Device ID: fsfe_001

Device Description: High Speed , Host EL_33,EL_34 Testing , Dummy Device.

Date: Thu Jun 21 11:44:49 IST 2001

Chirp Test Result: Pass

Measurement Name	Measurement Value	USB Limits	Status
Chirp Response Time	22.79975uS	Time = 100.0000uS	Pass
Chirp-K&J Duration	41.20952uS & 42.79060uS	40.00000uS to 60.00000uS	Pass

Page Setup Print Preview Print Close

Figure 119: Report in Tektronix-Specific format for Chirp Measurement

3. Select the manual generation mode.
4. Select the Generate button to display and view the selected report format.

Note: You can view the Plug-Fest specific report format as HTML pages and the .csv format in Microsoft Excel.

R-GPIB Commands

About the R-GPIB Program

An example of an R-GPIB program that can execute the TDSUSB2 measurement is included with the application. The oscilloscope hard disk and optional applications compact disc both contain the file, TDSUSB2_rgpib.c. On the hard drive, the file resides in the C:\Program Files\TekApplications\tdsusb2 directory.

This example shows how an R-GPIB program executes the application to do the following tasks:

1. Start up the application
2. Recall High Speed Signal Quality setup
3. Run the measurement
4. Generate the reports
5. Exit the application

R-GPIB Reference Materials

To use the R-GPIB commands with your oscilloscope, refer to the following materials:

- The TDSUSB2_rgpib.c file on the oscilloscope hard drive (located in the (located in the C:\Program Files\TekApplications\tdsusb2 directory) and optional application compact disc for an example of an R-GPIB command that can execute the application.
- The R-GPIB Program Example section for guidelines to use while designing the R-GPIB program.
- The programmer information is in the online help of your oscilloscope.

Introduction to the R-GPIB Commands

With the knowledge of R-GPIB command syntax, you can design an R-GPIB program to do the following tasks:

- Start the TDSUSB2 application
- Recognize an active application with R-GPIB protocol
- Program and read the application setup parameters
- Sequence measurements
- Generate reports

Guidelines to R-GPIB Programming

The application includes an example of an R-GPIB program for your reference as a program example. Your R-GPIB program should comply with the following guidelines:

- The application startup must complete before sending additional R-GPIB commands to the application (see example).
- To generate reports, first check whether the sequencer state is "Ready".
- Appropriate delay (for example: 2 secs) should be maintained between commands.
- The status variable should be checked to ensure that an error has not occurred because of a measurement command problem.
- R-GPIB event queue needs to be monitored. Make sure the event queue is clear before sending the next R-GPIB command to prevent event queue overflow.
- Commands are case and space sensitive. Your program will not operate correctly if you do not follow the capitalization and spacing precisely.

Launching the Application Using R-GPIB

You must manually set up the oscilloscope to launch the application. To start the TDSUSB2 application, you must send the oscilloscope the following R-GPIB command:

application:activate"USB2.0 Test Package"

The application uses the R-GPIB VARIABLE: VALUE command with arguments to execute some features. The set of R-GPIB commands includes the variable names and variable values necessary to select, configure, and run the measurements and to generate reports in the R-GPIB program.

You can select and configure the measurements that you want to use with your R-GPIB program.

Note: When using R-GPIB commands, the reports are saved in C:\TekApplications\tdsusb2\reports directory.

Variable: Value Command

Variable: Value Command

Description

This command accepts strings arguments for a control or data variable and a value to which to set the argument.

Syntax

VARIABLE:VALUE “<variable name>”,“<variable value>”

The arguments <variable name> and <variable value> are required in the order indicated.

VARIABLE:VALUE? “<variable name>” for query.

Note: Commands are case and space sensitive. Your program will not operate correctly if you do not follow the capitalization and spacing precisely.

Variable: Value TDSUSB2 Command Arguments and Queries- Application

Table 26. Variable: Value TDSUSB2 Command Arguments and Queries- Application

Variable Name	Valid values	Function	Querying Form
Terminating the application			
application	exit	Setting the value will terminate the running application	Returns the name of the currently running application

Variable: Value TDSUSB2 Command Arguments and Queries- Sequencer

Table 27. Variable: Value TDSUSB2 Command Arguments and Queries- Sequencer

Variable Name	Valid values	Function	Querying Form
Running measurements			
sequencerState	{Sequencing}-for Sequencing {Ready, Sequencing}-for Query	Sets the sequencer state	Returns the sequencer state

Variable: Value TDSUSB2 Command Arguments and Queries- Save/Recall

Table 28. Variable: Value TDSUSB2 Command Arguments and Queries- Save/Recall

Variable Name	Valid values	Function	Querying Form
setup	{Default, Recall, Save}	Sets the save/recall/default action	The default value for this variable is an empty string. The variable is set to the selected value momentarily and after completion of the task, it returns to its default value
recallName	It is recommended to have any string of length 1-8 chars, comprising of A-Z, a-z, 0-9	Sets the setup recall file name	Returns the setup recall file name
saveName	It is recommended to have any string of length 1-8 chars, comprising of A-Z, a-z, 0-9	Sets the setup save file name	Returns the setup save file name

Variable: Value TDSUSB2 Command Arguments and Queries- Report Generation

Table 29. Variable: Value TDSUSB2 Command Arguments and Queries- Report Generation

Variable Name	Valid values	Function	Querying Form
reportFormat	{tek, plug-fest, csv}	Sets the Report format to Tektronix specific, plug-fest specific or CSV format	Returns the current report format
reportName	It is recommended to have any string comprising of A-Z, a-z, 0-9 in the manual mode. Do not add file name extension to the report name	Sets the report file name	Returns the report file name
reportDirectory	It is recommended to have any string comprising of A-Z, a-z, 0-9 and '\'. End the directory name with '\'	Sets the directory to save the report	Returns the directory to save report
reportMode	{auto, manual}	Sets the report generation mode to automatic or manual	Returns the report generation mode
reportGenerate	generate	Generates the report in the manual mode	

Variable: Value TDSUSB2 Command Arguments and Queries- Results

Variable Name	Valid values	Function	Querying Form
resultFor	{eye, sigrt, jk, kj, con, eop, eopbit, cross, rt, ft, mon, in, pphost, pphost2, pphost3, ppdevice1, ppdevice2, resume, suspend, rfr, rfs, chirphost1, chirphost2, chirpdevice1}	Sets the result variables with appropriate result values for that particular test	After being set to a measurement value, the query returns "Busy" until the results are refreshed. Returns the selected measurement for result querying
reset	{Result}	Clears the active measurements results	
Statistical results-Basic statistics applicable for all SQC measurements			
measUnits			Units string for the measurement (for example "s" - seconds is the unit for Period)
max			Maximum value of the measurement
mean			Mean value of the result
min			Minimum value of the measurement
pkpk			Peak-to-peak value of the measurement
rms			RMS value of the result
population			Population (number of) measurements used to calculate the current statistics
stdDev			Standard deviation measurement set
status	{Pass, Fail, Conditional Pass}		Returns Pass/Fail result for the selected SQC measurement
Pass/Fail Status			
eyeStatus	{Pass, Fail, Conditional Pass}		Returns the eye diagram measurement
sqcOverallStatus	{Pass, Fail, Conditional Pass}		Returns the overall SQC measurement result
Inrush			
inCharge			Returns the inrush charge value
inCap			Returns the inrush capacitance value
inStatus	{Pass, Fail, Conditional Pass}		Returns the Pass/Fail status of inrush measurement

Variable Name	Valid values	Function	Querying Form
Packet Parameter			
ppOverallStatus	{Pass, Fail}		Returns the overall Pass/Fail status of the selected packet parameter measurement result
ppHostEL21Status	{Pass, Fail}		Returns the Sync Field Pass/Fail status
ppHostEL23			Returns the inter packet gap between first two packets
ppHostEL23Status	{Pass, Fail}		Returns the inter packet gap Pass/Fail status
ppHostEL25			Returns the EOP width in bits of the second packet
ppHostEL25Status	{Pass, Fail}		Returns the EOP width Pass/Fail status
ppHostEL22			Returns the inter packet gap between second and third packet
ppHostEL55			Returns the EOP width in bits
ppDeviceEL21Status	{Pass, Fail}		Returns the sync field Pass/Fail status
ppDeviceEL22			Returns the inter packet gap
ppDeviceEL22Status	{Pass, Fail}		Returns the inter packet gap Pass/Fail status
ppDeviceEL25			Returns the EOP width in bits
ppDeviceEL25Status	{Pass, Fail}		Returns the EOP width Pass/Fail status
Reset from Suspend/ Reset from High-Speed/Suspend/ Resume			
resetSusTime			Returns the reset from suspend time
resetSusStatus	{Pass, Fail}		Returns the reset from suspend status
susTime			Returns the suspend time
susStatus	{Pass, Fail}		Returns the suspend status
resetHSTime			Returns the reset from high speed time
resetHSStatus	{Pass, Fail}		Returns the reset from high speed status
resumeTime			Returns the resume time for upstream
resumeAmp			Returns the resume amplitude for downstream
resumeStatus	{Pass, Fail}		Returns the resume status

Variable Name	Valid values	Function	Querying Form
Chirp			
chirpHostEL33			Returns the host response time
chirpHostEL33Status	{Pass, Fail}		Returns the host response time status
chirpHostKEL34			Returns the host K duration
chirpHostJEL34			Returns the host J duration
ChirpHostEL34Status	{Pass, Fail}		Returns the host KJ duration status
chirpHostEL35			Returns the SOF time
chirpHostEL35Status	{Pass, Fail}		Returns the SOF time status
chirpDeviceEL28			Returns the device reset time
chirpDeviceEL28Status	{Pass, Fail}		Returns the device reset time status
chirpDeviceEL29			Returns the device K duration time
chirpDeviceEL29Status	{Pass, Fail}		Returns the device K duration time status
chirpOverallStatus	{Pass, Fail}		Returns the overall Pass/Fail status of the selected chirp measurement result
Additional Result			
additionalResult			Returns the additional result if applicable for selected measurement using resultFor

ResultFor Commands

The resultFor commands are of the format:

variable:value “<variable_name>”,“<value>”

Get or query commands are of the format:

variable:value? “<variable_name>”

Ensure that the order mentioned below is followed for the command script to work correctly. A sample script is listed here. It recalls a signal quality test setting, selects the test, runs the test, and queries the result. For example: Measured mean value for rise time test.

It is recommended to give a delay of at least one second between commands.

variable:value “recallName”, “sqc”

variable:value “setup”, “Recall”

variable:value “sequencerState”, “Sequencing”

.....keep polling until it returns a “Ready”

variable:value? “sequencerState”

“Ready”

variable:value “resultFor”, “rt”

variable:value? “resultFor”

“Busy”

.....keep polling until it returns a “rt”, the current test for which the result is queried

variable:value? “resultFor”

“rt”

variable:value? “mean”

1.88n

Sample Program

```
/* TDSUSB2
```

```
* This is a reference program to illustrate how to communicate with TDSUSB2  
* using Remote GPIB facilities.
```

Typically, the application does the following steps:

1. Start up the application
2. Recall Full Speed Signal Quality setup
3. Run the measurement
4. Generate the report
5. Exit the application

For the current program, we will recall a setup file named as sqcsetup.

You can save setup files according to your own needs using the GUI based interface of the application.

```
*/
```

```
#include <windows.h>  
#include <stdio.h>  
#include <stdlib.h>  
#include "decl-32.h"
```

```
/* Forward Declarations */  
int start_application(int scope);  
int exit_application(int scope);  
int do_single_test (int scope);  
int recall_setup( int scope, char *filename);
```

```
void display_results(int scope);

/* parameters needed to access the device driver
handler */

#define BDINDEX 0          // Board Index
#define PRIMARY_ADDR_OF_DMM 1 // Primary
address of device
#define NO_SECONDARY_ADDR 0 // Secondary
address of device
#define TIMEOUT T10s      // Timeout value
= 10 seconds
#define EOTMODE 1         // Enable the END
message
#define EOSMODE 0         // Disable the EOS
mode

char    ErrorMnemonic[21][5] = {"EDVR", "ECIC",
"ENOL", "EADR", "EARG",
    "ESAC", "EABO", "ENEB", "EDMA", "",
    "EOIP", "ECAP", "EFSO", "", "EBUS",
    "ESTB", "ESRQ", "", "", "", "ETAB"};

/*
 * After each GPIB call, the application checks
whether the call
 * succeeded. If an NI-488.2 call fails, the GPIB
driver sets the
 * corresponding bit in the global status
variable. If the call
 * failed, this procedure prints an error message,
takes
 * the device offline and exits.
*/
```

```
void GPIBCleanup(int ud, char* ErrorMsg)
{
    printf("Error : %s\nibsta = 0x%x iberr =
%d (%s)\n",
        ErrorMsg, ibsta, iberr,
        ErrorMnemonic[iberr]);
    if (ud != -1)
    {
        printf("Cleanup: Taking device
offline\n");
        ibonl(ud, 0);
    }
    exit(0);
}

int start_application( int scope )
{
    char write_buffer[100];
    char read_buffer[100];
    char app_name[] = "\"USB2.0 Test
Package\"\n";
    int status, timer;

    /* Start the TDSUSB2 application */
    sprintf(write_buffer, "%s",
"Application:activate \"USB2.0 Test Package\"");
    status = ibwrt(scope, write_buffer,
strlen(write_buffer));
    if (ibsta & ERR)
    {
        GPIBCleanup(scope, "Unable to start
the application");
        return 0;
    }
}
```

```

        timer = 1;
        while (1)
        {
            /* Check whether application has
started */
            sprintf(write_buffer, "%s",
"Variable:value? \"application\"");
            status = ibwrt(scope, write_buffer,
strlen(write_buffer));
            status = ibrd(scope, read_buffer,
sizeof(read_buffer));
            read_buffer[ibcnt] = '\0';
            if (strcmp(app_name, read_buffer) ==
0)
            {
                return 1;
            }
            timer++;
            if (timer > 60)
            {
                return 0;
            }
            Sleep(1000);
        }
        return 1;
    }

int exit_application(int scope)
{
    char write_buffer[100];
    printf("Exit Application ...\n");
    sprintf(write_buffer, "%s",
"Variable:value \"application\", \"exit\"");

```

```
    ibwrt(scope, write_buffer, strlen(write_buffer));
        return 1;
    }

int recall_setup(int scope, char* filename)
{
    char write_buffer[100];
    int status;

    /* Set Recall file name */
    sprintf(write_buffer, "%s%s%s",
"Variable:value \"recallName\",\", filename, "\");
    status = ibwrt(scope, write_buffer,
strlen(write_buffer));
    if (ibsta & ERR)
    {
        GPIBCleanup(scope, "Unable to
communicate with Scope");
        return 0;
    }

    Sleep(1000);

    /* Recall setup */
    sprintf(write_buffer, "%s",
"Variable:value \"setup\",\", \"Recall\");
    status = ibwrt(scope, write_buffer,
strlen(write_buffer));
    if (ibsta & ERR)
    {
        GPIBCleanup(scope, "Unable to
communicate with Scope");
        return 0;
    }
}
```

```

        return 1;
    }

    int run_test (int scope)
    {
        char write_buffer[100];
        char read_buffer[100];
        int timer;
        sprintf(write_buffer, "%s",
"Variable:value \"sequencerState\", \"Sequencing\"");
        ibwrt(scope, write_buffer,
strlen(write_buffer));
        printf("Executing Test...\n");
        Sleep(100);

        /* Wait for application to come to Ready
State */
        timer = 1;
        while (1)
        {
            timer++;
            if (timer > 90)
            {
                printf("*****Test Time Out
*****\n");
                return 0;
            }
            sprintf(write_buffer, "%s",
"Variable:value? \"sequencerState\"");
            ibwrt(scope, write_buffer,
strlen(write_buffer));
            ibrd(scope, read_buffer, 99);
            if (ibsta & ERR)
            {

```

```
        GPIBCleanup(scope, "Unable to
write to device");
    }
    read_buffer[ibcnt] = '\0';
    if
(strncmp(read_buffer, "\"Ready\"\n") == 0)
    {
        printf("Test Complete
...\n");
        return 1;
    }
    Sleep(1000);
}
}
```

```
void report_generate(int scope, char*
reportfilename)
{
    char write_buffer[100];
    char read_buffer[100];
    int status;

    /* Set report file name */
    sprintf(write_buffer, "Variable:value
\"reportName\", \"%s\"", reportfilename);
    printf("%s", write_buffer);

    status = ibwrt(scope, write_buffer,
strlen(write_buffer));
    if (ibsta & ERR)
    {
        GPIBCleanup(scope, "Unable to
communicate with Scope");
    }
}
```



```
        return;
    }

    Sleep(1000);

    /*Generate the report*/

    sprintf(write_buffer, "variable:value
\"reportGenerate\", \"generate\");
    printf("%s", write_buffer);

    ibwrt(scope, write_buffer,
strlen(write_buffer));
    if (ibsta & ERR)
    {
        GPIBCleanup(scope, "Unable to start
the application");
        return;
    }

    Sleep(2000);
    printf("\t Full Speed Signal Quality
Result stored\n");

}

void main()
{
    int Dev;
    char write_buffer[100];
    int status;
    Dev = ibdev (BDINDEX, PRIMARY_ADDR_OF_DMM,
NO_SECONDARY_ADDR,
TIMEOUT, EOTMODE, EOSMODE);
    if (ibsta & ERR)
    {
```

```

                                GPIBCleanup(Dev, "Unable to open
device");
                                }
                                else
                                {
                                    printf("My device id - %i", Dev);
                                }

                                Sleep(1000);

                                sprintf(write_buffer, "%s", "header off");
                                status = ibwrt(Dev, write_buffer,
strlen(write_buffer));
                                if (start_application(Dev))
                                {
                                    printf("\nApplication
started....\n");
                                }
                                Sleep(10000);
                                recall_setup(Dev, "sqcsetup");
                                Sleep(2000);
                                run_test(Dev);
                                Sleep(4000);
                                report_generate(Dev, "fs_sqc");
                                Sleep(2000);
                                exit_application(Dev);
                                /* leave the device back elegantly */
                                printf("Cleanup: Taking device
offline\n");
                                ibonl(Dev, 0);

                                }

```

Reference

Shortcut Keys

This table lists the shortcut keys that you can use for different tasks.

Table 30. Shortcut keys

Action	Shortcut Keys
File Menu	
Recall Default	AltF+D
Recall	AltF+R
Save	AltF+S
Preferences	AltF+P
Recently Recalled	AltF+C
Recently Saved	AltF+A
Minimize	AltF+N
Exit	AltF+X
Measurements Menu	
Select	AltM+S
Configure	AltM+C
Results Menu	
Summary	AltR+S
Details	AltR+D
Utilities Menu	
Deskew	AltU+K
Report Generator	AltU+R
TSV File Generator	AltU+T
Help Menu	
Help Topics	AltH+T
About TDSUSB2	AltH+A

Note: Use the Alt key with only the first keystroke. Release the Alt key before you press the final key. For example, to use the shortcut key AltF+D, press the Alt and F keys together. Release the keys and then press D.

USB2.0 Specifications

This section gives the USB2.0 values for measurements for Low, Full and High speed signals.

Low Speed

Table 31. Low Speed measurements

Measurements	USB Limits		User Configure Limits		References*
	Max	Min	Max. range	Min. range	
Cross-Over Voltage	2.0 V	1.3 V	1.6-2.4 V	1.04-1.56 V	Chapter 7, Table 7-7, Section 7.1.2.1
Signal Rate	1.5225 Mbps	1.4775 Mbps	1.5675-1.881 Mbps	1.146-1.4325 Mbps	Chapter 7, 7.1.11
Consecutive Jitter	<25 ns	N/A	20-30 ns	N/A	Chapter 7, 7.1.13.1
Paired Jitter	<10 ns	N/A	8-12 ns	N/A	Chapter 7, 7.1.13.1
Rise Time	300 ns	75 ns	240-360 ns	60-90 ns	Chapter 7, 7.1.2.1
Fall Time	300 ns	75 ns	1240-360 ns	60-90 ns	Chapter 7, 7.1.2.1
EOP Width	1.5e-6 s	1.25e-6 s	1.2-1.8	1-1.5 ns	Chapter 7, 7.1.13.2.1

*The References Section refers to the chapter numbers in the ‘Universal Serial Bus Specifications Revision 2.0-2000’.

Note 1: Results within the USB limit lead to a PASS condition. Results within the waiver limits, but outside USB limits lead to a Conditional PASS. Results within the user configured limits lead to PASS. When user configure limits is selected, you can view only the result details.

Note 2: Testing at Tier 6 leads to a PASS. Testing at Tier 5 and 4 leads to a Conditional PASS that is a Pass within the waiver limits. Testing at Tier 1 to 3 leads to a FAIL.

Full Speed

Table 32. Full Speed measurements

Measure-ments	USB Limits		User Configure Limits		References*
	Max	Min	Max range	Min range	
Cross-Over Voltage	2.0 V	1.3 V	1.6-2.4 V	1.04-1.56 V	Chapter 7, Table 7-7, Section 7.1.2.1
Signal Rate	12.03 Mbps	11.97 Mbps	12.15 to 14.8 Mbps	9.48-11.85 Mbps	Chapter 7, 7.1.13.1
Consecutive Jitter	<2 ns	N/A	1.6-2.4 ns	N/A	Chapter 7, 7.1.13.1
Paired Jitter	<1 ns	N/A	.8-1.2 ns	N/A	Chapter 7, 7.1.13.1
Rise Time	20 ns	4 ns	16-24 ns	3.2-4.8 ns	Chapter 7, 7.1.2.1
Fall Time	20 ns	4 ns	16-24 ns	3.2-4.8 ns	Chapter 7, 7.1. 2.1
EOP Width	175 ns	160 ns	140-210 ns	128-192 ns	Chapter 7, 7.1.13.2.1

References Section refers to the chapter numbers in the ‘Universal Serial Bus Specifications Revision 2.0-2000’.

Note 1: Results within the USB limits lead to a PASS. Results within the waiver limits, but outside USB limits lead to a Conditional PASS. Results within the user configured limits lead to a PASS result. If you select configured limits, you can view only the result details.

Note 2: Testing at Tier 6 leads to a PASS. Testing at Tier 5 and 4 leads to a Conditional PASS that is a Pass within the waiver limits. Testing at Tier 1 to 3 leads to a FAIL.

Note 3: The application uses the USB signal rate limits of Low Speed or Full Speed devices that are not capable of High Speed. The same limits for Low Speed or Full Speed that are High Speed capable to decide the result - PASS or FAIL.

High Speed

Table 33. High Speed measurements

Measurements	USB Limits		User Configure Limits		80% to 120%	References*
	Max	Min	Max range	Min range	USB Pass/Fail	
Signal Rate	480.24 Mbps	479.76 Mbps	480.264-576.3168 Mbps	383.7888-479.736 Mbps	YES	Chapter 7, 7.1.11
Rise Time	N/A	500ps	N/A	400-600 ps	YES	Chapter 7, 7.1.22
Fall Time	N/A	500ps	N/A	400-600 ps	YES	Chapter 7, 7.1.22
Monotonicity	0	0	N/A	N/A	N/A	N/A
EOP Width	8.5 bit times	7.5 bit times	8.5-10.2 bit times	6-7.5 bit times	YES	Chapter 7, 7.1.13.2.2

*The References Section refers to the chapter numbers in the ‘Universal Serial Bus Specifications Revision 2.0-2000’.

Note 1: Results within the USB limits lead to a PASS. Results within the waiver limits, but outside USB limits lead to a Conditional PASS. Results within the user configured limits lead to PASS. If you select your configured limits, you can view only the result details.

Note 2: Whenever a high speed device is used in the low speed and full speed mode, the USB limits of the low speed and full speed devices are used to decide PASS or FAIL.

Note 3: USB2.0 specifications have not specified the maximum rise time and fall time. If rise or fall times are greater than 0.5 bits, then a wrong, (long) rise or fall time will be captured as an eye diagram failure.

Inrush Current Check

Table 34. Inrush Current measurements

Measurements	USB Limits		User Configure Limits		80% to 120%	References*
	Max	Min	Max range	Min range	USB Pass/Fail	
Hot Plug Attach						
VBUS Default Volts 5.15	5.25V	4.4 V	N/A	N/A	YES	Chapter 7, 7.22
Inrush Level	100 mA	N/A	80-120 mA	N/A	YES	Current Draw.pdf

Droop Test

Table 35. Inrush Current measurements

Measurements	USB Limits		User Configure Limits		80% to 120%	References*
	Max	Min	Max range	Min range	USB Pass/Fail	
Droop Compliance Voltage	<330 mV	70.0 mV	264-396 mV	N/A	YES	Chapter 7, 7.2.4.1

*References Section refers to the chapter numbers in ‘Universal Serial Bus Specifications Revision 2.0-2000’.

Error Codes and Warnings

This section gives a list of error codes that the application displays and their descriptions.

Table 36. Error Code descriptions

Error Codes	Error Message	Description	Possible Solutions
Sequencer Errors			
E101	Error importing waveform from the oscilloscope	The application is trying to import the waveform(s) from the selected source(s), but is not able to import the waveform to the application	Make sure that the application settings are the same as the selected oscilloscope channels. Check the probe connections and the compliance test fixture connections for the live signal(s)
E102	Error in accessing .tsv file	This error occurs whenever .tsv file is selected as the source file and this file is not a valid .tsv file	Check whether the file name extension is .tsv. The selected .tsv source file may be corrupted. Try running the application with a different tsv file
E103	Mismatch in the .tsv file format	The .tsv file should match the file structure mentioned in Reference section of this help. For Low and Full Speed signals, each data record should have three values (Timestamp, D+, D-). For a High Speed .tsv file, the file should have two columns (Time, Diff). Use a valid file	Try generating the .tsv file using .tsv File Generator utility that is available in the Utilities menu
E104	Record length is more. Set the record length to less than XXXXXX data points	The record length is too high for the waveform	Click the "Horiz" button or "Horiz/Acq" Menu from the oscilloscope UI. Go to Horizontal tab and decrease the record length

Table 36. Error Code descriptions (cont.)

Error in acquiring waveform from oscilloscope			
E111	Timeout occurred while acquiring a waveform	This is the GPIB timeout information that appears when the application is acquiring the waveform	Make sure the probe and compliance test fixture connections are proper. Reacquire the new waveform
E112	Error in turning on a channel	The application failed to turn on the live channel selected as source(s)	Make sure the probe and compliance test fixture connections are proper. Reacquire the new waveform
E113	Error in importing waveform from instrument	The operation of importing the waveform from the acquisition memory failed. This will fail whenever there is no valid waveform in the acquisition memory	Make sure the probe and compliance test fixture connections are proper. Reacquire the new waveform
Packet Detection Warning			
E201	No EOP region found	Testing will be performed on an full USB2.0 packet, which includes an EOP region. If no EOP region is found, the results might be incorrect since testing will be performed on a incomplete packet. For Upstream signal quality testing, EOP must be present	Try acquiring the signals again by pressing Run button
E202	Number of record points (data points) are too few to process	At least 500 record points are required to perform an operation. The application automatically sets the required record length. The user should not change the record length	Try acquiring the signals again the pressing Run button
E203	Idle region is not found after EOP	As part of the USB2.0 packet description, an EOP region follows an idle region. If no idle region is found, it may lead to incorrect results	Try acquiring the signals again by pressing the Run button
E204	Reconfirm acquired data before computing the results	As part of the USB2.0 packet description, a minimum of three J-K or K-J state transitions are expected. An absence of these transitions may lead to incorrect results	Try acquiring the signals again by pressing the Run button
Signal rate measurement errors or warning			
E301	There should be at least two Cross-Over time values to calculate the signal rate	For signal rate calculations, the application expects a minimum of two Cross-Over points	Try acquiring the signals again by pressing the Run button
E306	Device/ File doesn't match with the selected speed	The signal rate should be within 30% of the specified signal rate of the Low, Full and High Speed signals	Please check the speed of the connected device. Ensure that the selection in the application is the same. For example, if a Low Speed unit is under test, make sure Low Speed is selected in the application

Table 36. Error Code descriptions (cont.)

JK and KJ Jitter Measurement Errors			
E304	Number of bits is not sufficient to calculate JK jitter	More than four Cross-Over points are expected by the algorithm	Try acquiring the signal again by pressing Run button
E305	Number of bits is not sufficient to calculate KJ jitter	More than four Cross-Over points are expected by the algorithm	Try acquiring the signal again by pressing Run button
Report Generation Errors			
E401	Error generating report in Plug Fest format	This error is generated if there are no results to process	Check if the valid directory and file name is selected for report generation. Check if the file name extension is .htm. Try generating the report again by pressing Run button
E402	Error Generating report in Tek format	This error is generated if there are no results to process	Check if the valid directory and file name are selected for report generation. Check if the file name extension is .htm. Try generating the report again by pressing Run button
E403	Error Generating report in CSV format	This error is generated if there are no results to process	Check if the valid directory and file name s are selected for report generation. Check if the file name extension is .htm. Try generating the report again by pressing Run button.
E404	No results present to generate report	This error is generated if there are no results present for the USB Inrush, Droop and Signal Quality Check Reports	Press the Run button to get the results and try again
E405	Could not generate a report as the Eye diagram is missing	This error is generated if there is no eye diagram found in C:\TekApplications\TDSUSB2\temp	Press the Run button and perform the measurements again
E406	Could not generate report as Waveform plot is missing	This error is generated if there is no waveform plot found in C:\TekApplications\TDSUSB2\temp	Press the Run button and perform the measurements again
Eye Measurements			
E601	The maximum zoom factor has been reached	N/A	Press the Reset button or use the Zoom out feature.
E602	Signal not proper, check the signal	This is a check to confirm the acquired waveform	Try acquiring the correct waveform
Inrush Measurements			
E501	Final data point is still above the inrush threshold	The signal has not fallen below the Inrush threshold level	Try acquiring the correct waveform

Table 36. Error Code descriptions (cont.)

Utilities			
E701	Number of edges found in the waveform is less than required edges (user input) to perform the deskew operation	Before the deskew operation can start, the edge(s) available for deskew operation must be greater than or equal to the number of edges needed	Adjust the timebase and (or) increase the record length. Perform the deskew operation by entering less number of edges
E702	Propagation delay is more than one cycle	The deskew operation is performed on the same signal source. Check whether dissimilar signals or any external sources (like different probes) are used	Check whether the same signal source is used for the "From" and "To" channels. Check whether the bandwidth of the probes is sufficient for the signal bandwidth
E701	Number of edges found in the waveform is less than required edges (user input) to perform the deskew operation	Before starting the deskew operation, the application tries to find out if the edge(s) available for deskew operation is greater than or equal to the number of edges needed	Adjust the timebase and (or) increase the record length. Perform the deskew operation by entering less number of edges
E702	Propagation delay is more than one cycle	The deskew operation is performed on the same signal source. Check whether dissimilar signals or any external sources (like different probes) are used	Check whether the same signal source is used for the "From" and "To" channels. Check whether the bandwidth of the probes is sufficient for the signal bandwidth
TSV File Generator			
E721	Error in generating a .tsv file	This message is generated if there is an error while generating the .tsv file for the given inputs	Check the correctness of the input .csv file(s) and the output .tsv file
E722	Timestamp of the two .csv files did not match. Conversion failed	There will be two separate .csv files, one for D+ and another for D-. Each of these files consists of the time values of the D+ and D- signal. It is expected that both the files should have Data at same time stamp	Try generating the .tsv file with a new set of .csv files
E725	Invalid CSV file format	This happens if the user does not use a valid CSV file format for the CSV-TSV file conversion	Check whether the CSV files are generated using the supported instruments and ensure that "Include waveform scale factors" is selected while generating a CSV file
E723	.csv file(s) not found	The .csv file(s) are needed for the .csv source mode selection is not found. Two valid .csv files are needed for the Single-ended signals and one valid .csv file is needed for Differential signals	Check that the extension of the file(s) is .csv. Make sure to press the Enter key while entering the file name in the file selection field to update old file names
E724	tsv file not found	A valid .tsv file is needed as destination file	Make sure to press the Enter key while entering the file name in the file selection field to update old file names. Enter the .tsv extension while entering the file name

Table 36. Error Code descriptions (cont.)

Save and Recall			
E751	The file name has invalid characters and could not be saved	The application expects the file names in alphanumeric characters	Make sure the valid characters are used in the file names
E754	The file name has invalid characters and could not be recalled	The application expects the file names in alphanumeric characters	Make sure that valid characters are used in the file names
E752	The file doesn't exist	The file name selected for recall does not exist	Recall an existing file name
E753	The saved file has been corrupted and not recalled	The application saves the application settings with the .ini file extension. The user should not modify the data inside the file	Try recalling a correct file. Store the settings to a new file and recall it when needed
Save and Recall			
E801	The current signal is not a Chirp Signal. Acquire the correct signal and proceed	The acquired signal is not a correct Chirp Signal. Correct Chirp Signal is required to perform chirp measurements	Try acquiring the signals again by pressing Run button
E802	No Chirp-K or Chirp-J state found	As part of the USB2.0 Chirp description, a minimum of 1 Chirp-K and 1 Chirp-J state are expected after Chirp Response timing calculation	Press the Run button to acquire the signals
E803	There should be at least 3 Chirp-K and 3 Chirp-J state	As part of the USB2.0 Chirp description, a minimum of three Chirp-K and three Chirp-J state are expected after Chirp Response timing. An absence of this may lead to incorrect results	Press the Run button to acquire the signals
E-804	No Chirp-J state found	As part of the USB2.0 Chirp description, a minimum of one Chirp-J state is expected after Chirp Response timing. An absence of this may lead to incorrect results	Press the Run button to acquire the signals
E-805	No Chirp-K state found	As part of the USB2.0 Chirp description, a minimum of one Chirp-K state is expected after Chirp Response timing. An absence of this may lead to incorrect results	Press the Run button to acquire the signals

Table 36. Error Code descriptions (cont.)

Rise Time/ Fall Time Measurement			
E901	The High level values needs to be decreased	This message is displayed if no edge is found in the high level	Decrease the percentage of the high level values of Rise Time/Fall Time
E902	The Low level values needs to be increased	If no edge is found in the low level the message is displayed	Decrease the percentage of the low level values of Rise Time/Fall Time
E903	Both the High and Low level values needs to be changed	If no edge is found in the high and low level the message is displayed	Increase and decrease the percentage of the high and low level values of Rise Time/Fall Time
E904	The calculated Rise Time is more than the calculated bit time of the input signal	This warning appears when the calculated Rise Time is more than the calculated bit time of the input signal	Increase the lower level and decrease the upper level of the configure limits of Rise Time/Fall Time
E905	The calculated Fall Time is more than the calculated bit time of the input signal	This warning appears when the calculated Fall Time is more than the calculated bit time of the input signal	Increase the lower level and decrease the upper level of the configure limits of Rise Time/Fall Time
E906	The calculated Rise Time and Fall Time is more than the calculated bit time of the input signal	This warning appears when the calculated Rise Time and Fall Time is more than the calculated bit time of the input signal	Increase the lower level and decrease the upper level of the configure limits of Rise Time/Fall Time

Table 36. Error Code descriptions (cont.)

Miscellaneous			
E1000	Invalid device Chirp-K for this test	As part of the USB2.0 description, a minimum of 3 Chirp-K and 3 Chirp-J states are expected after Chirp Response timing. An absence of this may lead to incorrect results	Try acquiring the signals again by pressing Run button
E1001	No SOF found	No SOF in D+ and D-	Power off the DUT, check the probe connection and try acquiring the signal
E1002	The current signal is not a Reset From Suspend signal. Acquire the correct signal and proceed	Acquired signal is not a correct Reset From Suspend signal. Correct Reset From Suspend Signal is required to perform the measurement	Try acquiring the signals again by pressing Run button
E1003	The current signal is not a Resume signal acquire the correct signal and proceed	Acquired signal is not a correct Resume signal. Correct Resume signal is required to perform the measurement	Try acquiring the signals again by pressing Run button
E1004	The current signal is not a Suspend signal acquire the correct signal and proceed	Acquired signal is not a correct Suspend signal. Correct Suspend signal is required to perform the measurement	Try acquiring the signals again by pressing Run button
E1005	There is no falling edge transition for this test.	If there is no J state found	Try acquiring the signals again by pressing Run button
E1006	There is no start of Chirp-K state for this device	If there is no K state found	Try acquiring the signals again by pressing Run button
E1007	There is no K State transition driven by the host controller	If there is no K state found	Try acquiring the signals again by pressing Run button
E1008	The current signal is not a Reset From Resume signal. Acquire the correct signal and proceed	The acquired signal is not a correct Reset From Resume signal. Correct Reset From Resume signal is required to perform the measurement	Try acquiring the signals again by pressing Run button

Settings for the supported Instruments

This section gives a list of default oscilloscope settings the application uses for supported instruments.

The recommended voltage probes for single-ended signals are the P6245, TAP1500 probes and for differential signals is the P6248 probe. The next table shows the oscilloscope settings for Low Speed and Full Speed signals for the supported instruments.

Upstream Setups for Low Speed signals

Table 37. Oscilloscope settings for low speed signals

Ch.	Vertical Setup Pos.				Horizontal Setup Record			Trigger Setup Trigger Logic Pattern Threshold					Repeat State
	Scale	Offset	Coupling		Main Trigger Length	Scale	Position	Trigger Type	Function	Limit	Mode		
Ch1(D-)	0	1V	0	DC	5000	2.00 E-07s	74%	Logic	AND	>100 ns	800 mV	Normal	Off
Ch2(D+)	0	1V	0	DC	N/A	N/A	N/A	N/A	N/A	N/A	800 mV	N/A	N/A
Ch3 Qualify	0	1V	0	DC	N/A	N/A	N/A	N/A	N/A	N/A	2.7 V	N/A	N/A

Upstream Setups for Full Speed signals

You can test the Full Speed devices at Tier 6. This testing is also known as legacy testing.

When Full Speed and Low Speed device are High Speed capable, the application uses the signal rate limits of Full Speed/Low Speed devices that are not High Speed capable to determine PASS or FAIL.

Table 38. Oscilloscope settings for full speed signals

Ch.	Vertical Setup Pos.				Horizontal Setup			Trigger Setup Trigger Logic Pattern					Repeat State
	Scale	Offset	Coupling		Record Main Trigger Length	Scale	Pos.	Threshold	Function	Limit	Mode		
Ch1 (D-)	0	1V	0	DC	5000	25 E-9s	83%	Logic	AND	>100 ns	800 mV	Normal	Off
Ch2 (D+)	0	1V	0	DC	N/A	N/A	N/A	N/A	N/A	N/A	800 mV	N/A	N/A
Ch3 Qualify	0	1V	0	DC	N/A	N/A	N/A	N/A	N/A	N/A	2.7 V	N/A	N/A

Downstream Setups for Low Speed signals

Table 39. Downstream settings for low speed signals

Ch.	Vertical Setup Position Scale Offset Coupling				Horizontal Setup Record Main Trigger length scale pos.			Trigger Setup Trigger Slope Threshold Trigger type mode			
	Ch1 (D-)	0	1V	0	DC	2500	5.00 E-07s	6%	Edge	Rise	1.65 V
Ch2 (D+)	0	1V	0	DC	N/A	N/A	N/A	N/A	N/A	800 mV	N/A

Downstream Setups for Full Speed signals

Table 40. Downstream settings for low speed signals

Ch.	Vertical Setup Position Scale Offset Coupling				Horizontal Setup Record Main Trigger length scale pos.			Trigger Setup Trigger Slope Threshold Trigger type mode				Repeat State	Hold Off Mode
	Ch1 (D-)	-1.5	1 V	0	DC	5000	50.0 E-9 s	5%	N/A	N/A	N/A		
Ch2 (D+)	-1.5	1 V	0	N/A	N/A	N/A	N/A	Edge	Rise	1.65 V	Normal	Off	N/A

Upstream Setup for High Speed signals

Probe Function External Attenuation 1.0

Table 41. Upstream settings for high-speed signals

Ch.	Vertical Setup Position Scale Offset			Horizontal Setup Record Main Trigger Fit to Length scale pos.				Trigger Setup Trigger Threshold Trigger Type mode			Repeat State	Hold Off Mode	Display Mode
	Differential	0	0.1 V	0	20000	2.00 E-07	10%	On	Edge	176 mV			

Inrush Setup

Table 42. Inrush current settings

Vertical Setup Pos. Coupling	Scale Offset			Horizontal Setup Record Main Trigger length scale pos.			Trigger Setup Trigger Slope Threshold Trigger type mode				Display Mode	Hold Off Mode
	-3	1 A	0	DC	25000	1.00E-05	10%	Edge	Rise	20 mA		

Droop Setup

Table 43. Droop settings

Ch.	Vertical Setup Pos. Scale Offset Coupling				Horizontal Setup Record Main Trigger length scale pos.			Trigger Setup Trigger Slope Threshold Type			Display Mode	Acquisition Mode
Ch1 (Vbus)	2	200 mV	5	DC	5000	2.00 E-05	50%	N/A	N/A	N/A	N/A	Average 16 Points
Ch2 Droop Trigger load	-3	2 V	0	DC	N/A	N/A	N/A	Edge	Rise	2.5 V	Sin(x)/x	N/A

Chirp Device EL_28, EL_29 EL_31 setup

Table 44. Chirp Device settings

Ch.	Vertical Setup Pos. Scale Offset Coupling				Horizontal Setup Record Main Trigger length scale pos.			Trigger Setup Trigger Slope Threshold Trigger type mode				Rpt State	Hold Off	Display Mode
Ch1 (D+)	-3.4	.5V	0	DC	5000	4.00E-04	5%	Edge	Fall	1.35 V	Normal	Off	1.00 E- 04	Sin(x)/x
Ch2 (D-)	-3.4	.5 V	0	DC	N/A	N/A	N/A	N/A	N/A	N/A	N/A	N/A	N/A	N/A

Chirp Host EL_33, EL_34 setup

Table 45. Chirp Host settings

Ch.	Vertical Setup Pos. Scale Offset Coupling				Horizontal Setup Record Main Trigger length scale pos.			Trigger Setup Trigger Slope Threshold Trigger type mode				Rpt state	Hold off	Display mode
Ch1 (D+)	-3.4	.5V	0	DC	5000	4.00E-04	5%	Edge	Fall	1.35 V	Normal	Off	1.00 E- 04	Sin (x)/x
Ch2 (D-)	-3.4	.5 V	0	DC	N/A	N/A	N/A	N/A	N/A	N/A	N/A	N/A	N/A	N/A

Chirp Host EL_35 setup

Table 46. Chirp Host EI_35 settings

Ch.	Vertical Setup Pos. Scale Offset Coupling				Horizontal Setup Record Main Trigger length scale pos.			Trigger Setup Trigger Polarity Threshold Trigger type Mode				Repeat state	Width	Filter	Hold off	Display mode
Ch1 (D+)	-3.40	.5V	0	DC	12500	1.00E-03	95%	Pulse (Glitch)	Positive	0.30 V	Normal	Off	9.0E-9	Accept	5.00 E-5	Sin(x)/x
Ch2 (D-)	-3.4	.5 V	0	DC	N/A	N/A	N/A	N/A	N/A	N/A	N/A	N/A	N/A	N/A	N/A	N/A

Suspend Setup

Table 47. Suspend settings

Ch.	Vertical Setup				Horizontal Setup			Trigger Setup				Rpt state	Hold off	Display mode
	Pos	Scale	Offset	Cpling	Reclen	Main scale	Trigpos	Trigtype	Slope	Threshold	Trigmd			
Ch1 (D+)	-2.96	.5V	0	DC	20000	4.00E-04	90%	Edge	Rise	2.69V	Normal	Off	Auto	Sin(x)/x
Ch2 (D-)	-1.72	.5 V	0	DC	N/A	N/A	N/A	N/A	N/A	N/A	N/A	N/A	N/A	N/A

Resume Setup

Table 48. Resume settings

Ch.	Vertical Setup				Horizontal Setup			Trigger Setup				Repeat state	Hold off	Display mode
	Pos	Scale	Offset	Cpling	Reclen	Main scale	Trig pos	Trigtype	Slope	Threshold	Trigmd			
Ch1 (D+)	-3.40	.5V	0	DC	50000	2.00E-05	10%	Edge	Fall	0.690 V	Normal	Off	1.00 E-5	Sin(x)/x
Ch2 (D-)	-3.40	.5 V	0	DC	N/A	N/A	N/A	N/A	N/A	N/A	N/A	N/A	N/A	N/A

Reset from High Speed

Table 49. Reset from high speed settings

Ch.	Vertical Setup				Horizontal Setup			Trigger Setup				Repeat state	Hold off	Display mode
	Pos	Scale	Offset	Cpling	Reclen	Main scale	Trigpos	Trigtype	Slope	Threshold	Trigmd			
Ch1 (D+)	-3.40	.5V	0	DC	25000	1.00E-03	70%	Edge	Fall	0.690 V	Normal	Off	1.00 E-5	Sin(x)/x
Ch2 (D-)	-3.40	.5 V	0	DC	N/A	N/A	N/A	N/A	N/A	N/A	N/A	N/A	N/A	N/A

Reset from Suspend

Table 50. Reset from Suspend settings

Ch.	Vertical Setup				Horizontal Setup			Trigger Setup				Repeat state	Hold off	Display mode
	Pos	Scale	Offset	Cpling	Reclen	Main scale	Trigpos	Trig type	Slope	Threshold	Trigmd			
Ch1 (D+)	-3.40	.5V	0	DC	50000	1.00E-03	15%	Edge	Fall	1.8 V	Normal	Off	1.00 E-5	Sin(x)/x
Ch2 (D-)	-3.40	.5 V	0	DC	N/A	N/A	N/A	N/A	N/A	N/A	N/A	N/A	N/A	N/A

Packet Parameter

Table 51. Packet Parameter settings

Ch.	Vertical Setup				Horizontal Setup			Trigger Setup				Repeat state	Hold off	Display mode
	Pos	Scale	Offset	Cpling	Reclen	Mainscale	Trigpos	Threshold	Trigtype	Slope	Trigmd			
Ch1 (D+)	0.0	0.2V	0	DC	50000	50	50	Width	Fall	N/A	Normal	Off	1.00 E-5	Sin(x)/x
Ch2 (D-)	0.0	0.2V	0	DC	N/A	N/A	N/A	N/A	N/A	N/A	N/A	N/A	N/A	N/A

Parameters

About Application Parameters

This section describes the TDSUSB2 application parameters, and includes the menu default settings. You should refer to the user manual for your oscilloscope for operating details of other controls, such as front-panel buttons.

The parameters for the menus and options list the selections or range of values available for each, and include the default values.

File Menu Parameters

There are no parameters for the File menu items.

Save and Recall Menu Parameters

There are no parameters for the Save and Recall menu.

Preferences Parameters

Table 52. Preferences parameters

Parameters	Selections	Default setting
Warn if the configuration was not changed since last run, when Run button is pressed	On, Off	On
Show the Eye Diagram automatically, without having to press the Eye Diagram button in the Results screen	On, Off	On
Show the Waveform Plot automatically without having to press Waveform Plot button in the Results screen	On, Off	On
Ask for Filename or Device ID before automatically generating Reports or Data files	On, Off	Off
Automatically generate Data files (TSV)	On, Off	Off
Show the report when generated	On, Off	On
Always display the waiver mask for High Speed Near-end and Low Speed Eye Diagrams	On, Off	Off
Do Autoset Every Time	On, Off	On
LS or FS device with USB2.0 silicon	On, Off	Off
Allow the user configuration of test limits	On, Off	Off
Prompt for the Droop Test readout during Report Generation	On, Off	Off
Packet identification by user using cursors	On, Off	Off

Parameters	Selections	Default setting
Modify HoldOff	250 ns to 12 s	1.2 μ s

Measurement Menus

The options available under the Measurements menu are as follows:

- [Select](#)
- [Configure](#)

Measurement Parameters

The next table lists the options in the Select Measurements menu by area:

Table 53. Measurement parameters

Parameters	Selections	Default setting
Low Speed	Eye Diagram Signal Rate EOP Width Rise Time Fall Time Cross-Over Voltage Consecutive Jitter Paired JK Jitter Paired KJ Jitter Inrush Current Droop test	None
Full Speed	Eye Diagram Signal Rate EOP Width Rise Time Fall Time Cross-Over Voltage Consecutive Jitter Paired JK Jitter Paired KJ Jitter Inrush Current Droop test	Eye Diagram

Table 53. Measurement parameters (cont.)

High Speed	Eye Diagram Signal Rate EOP Width Rise Time Fall Time Monotonic Property Chirp Receiver Sensitivity Inrush Current Droop test Packet Parameter Suspend Resume Reset from High Speed Reset from Suspend	None
Device ID	User defined or fsfe_001	fsfe_001
Device Description	User defined or Dummy Device	Dummy Device

Configure Menu

You can configure the parameters for the selected measurements. The configurations for the Signal Quality, Inrush, and Droop tests are available as different menus.

Configure Signal Quality Measurements Parameters

Configure

Table 54. Configure Signal Quality parameters

Parameters	Selections	Default setting
Tier	Tier 1, Tier 2, Tier 3, Tier 4, Tier 5, Tier 6	Tier 6
Direction	Upstream, Downstream	Upstream
Test Point	Near End, Far End	Far End

Source

Table 55. Configure Signal Quality Source parameters

Parameters	Selections	Default setting
Live/Ref	Differential Ch1, Ch2, Ch3, Ch4 Ref1, Ref2, Ref, Ref4	Ch1
Live/Ref Single Ended D+	Ch1, Ch2, Ch3, Ch4 Ref1, Ref2, Ref, Ref4	Ch1
Single Ended D-	Ch1, Ch2, Ch3, Ch4	Ch2
Qualifier	Ch1, Ch2, Ch3, Ch4 Ref1, Ref2, Ref, Ref4	Ch3
File	None	C:\TekApplications\tdsusb2\tsvfiles\FS_SQC.tsv

Configure Inrush Current Measurement Parameters

Configure

Table 56. Configure Inrush Current Measurement parameters

Parameters	Selections	Default setting
Tier	None	Tier 1
Vbus	Range	5.15V
Device Type	Hot Plug Attach, Low Power Configure Low Power Resume, High Power Configure, High Power Unconfigure, High Power Resume	Hot Plug Attach

Source

Table 57. Configure Inrush Current Source Measurement parameters

Parameters	Selections	Default setting
Live/Ref	Ch1, Ch2, Ch3, Ch4Ref1, Ref2, Ref, Ref4	Ch4
File	None	C:\TekApplications\tdsusb2\tsvfiles\LS_INRUSH.tsv

Configure Droop Test Parameters

Configure

Table 58. Configure Droop Test parameters

Parameters	Selections	Default setting
Port	Port 1, Port 2, Port 3, Port 4, Port 5, Port 6, Port 7	Port 1
Device Type	Self Powered Hub Bus Powered Hub	Bus Powered Hub

Source

Table 59. Droop Test Source parameters

Parameters	Selections	Default setting
Live/Ref	Ch1, Ch2, Ch3, Ch4 Ref1, Ref2, Ref, Ref4	Ch1
VBUS channel Trigger	Ch1, Ch2, Ch3, Ch4 Ref1, Ref2, Ref, Ref4 Ch1, Ch2, Ch3, Ch4	Ch2
File	None	C:\TekApplications\tdsub2\tsvfiles\FS_SQ C.tsv
VBUS source	Ch1, Ch2, Ch3, Ch4	Ch1

Configure Receiver Sensitivity

Table 60. Receiver Sensitivity parameters

Parameters	Selections	Default setting
Source	Ch1, Ch2, Ch3, Ch4	Ch 1

Configure Suspend, Reset from High Speed, Resume, Reset from Suspend

Table 61. Configure Reset, Resume, Suspend parameters

Parameters	Selections	Default setting
Signal Direction	Upstream, Downstream	Upstream
Source	D+ Ch1, Ch2, Ch3, Ch4 Ref1, Ref2, Ref3, Ref4 D-Ch2, Ch3, Ch4 Ref1, Ref2, Ref3, Ref4	Ch1 Ch2

Configure Packet Parameter

Table 62. Configure Packet parameters

Parameters	Selections	Default setting
DUT	Host, Device	Host
Host	EL_21, EL_23, EL_25 EL_55 EL_22	EL_21, EL_23, EL_25
Source	Ch1, Ch2, Ch3, Ch4 Ref1, Ref2, Ref3, Ref4	Ch1
Device	EL_21, EL_22, EL_25 EL_22	EL_21, EL_22, EL_25
Source	Ch1, Ch2, Ch3, Ch4 Ref1, Ref2, Ref3, Ref4	Ch1

Configure Chirp

Table 63. Configure Chirp parameters

Parameters	Selections	Default setting
DUT	Host, Device	Host
Host	EL_33, EL_34 EL_35	EL_33, EL_34
Source	D+-Ch1, Ch2, Ch3, Ch4 Ref1, Ref2, Ref3, Ref4 D--Ch2, Ch3, Ch4 Ref1, Ref2, Ref3, Ref4	Ch1 Ch2
Device	EL_28, EL_29, EL_31	EL_28, EL_29, EL_31
Source	D+-Ch1, Ch2, Ch3, Ch4 Ref1, Ref2, Ref3, Ref4 D--Ch2, Ch3, Ch4 Ref1, Ref2, Ref3, Ref4	Ch1 Ch2

Results Menus

There are no parameters for the Results Menus.

Utilities Menus

There are three Utilities menu items:

- [Deskew](#)
- [Report Generator](#)
- [TSV File Generator](#)

Deskew

Table 64. Deskew parameters

Parameters	Selections	Default setting
Source1	Ch1, Ch2, Ch3, Ch4	Ch1
Ref level1	0 -100 %	50%
Hysteresis1	0-25%	5%
Source2	Ch1, Ch2, Ch3, Ch4	Ch2
Ref level2	0 -100 %	50%
Hysteresis2	0-25%	5%
Slope	Rise, Fall	Fall
Edges	1 to 50	1

Report Generator Menu Parameters

Table 65. Report Generator Menu parameters

Parameters	Selections	Default setting
Report Format	Tektronix specific, Plug-Fest format, CSV format	Tektronix specific
Generation	Automatic, Manual	Manual
File name	fsfe_001-tek.htm	C:\TekApplications\tdsub2\report\fsfe_001-tek.htm
Report Directory	None	C:\TekApplications\tdsub2\report

TSV File Generator Menu Parameters

Table 66. TSV File Generator Menu parameters

Parameters	Selections	Default setting
Input	CSV, Live	C:\TekApplications\tdsusb2\csv files\csvFile001.csv
CSV Waveform Source	Single-Ended (D+ D-) Differential	Single-Ended C:\TekApplications\tdsusb2\tsvfilegenerator\Dplus.csv C:\TekApplications\tdsusb2\tsvfilegenerator\Dminus.csv C:\TekApplications\tdsusb2\tsvfilegenerator\Differential.csv
TSV File name	TSV Source File	C:\TekApplications\tdsusb2\tsvfilegenerator\TsvFile001.tsv

Help Menu

Help Topics - Displays the help file for the TDSUSB2 application.

About TDSUSB2 - Displays a dialog box with information about the current TDSUSB2 application.

Control Menu

Control Menu Parameters

Table 67. Control parameters

Parameters	Selections
Run	None
Hide	None
Exit	None

Measurement Algorithms

About Measurement Algorithms

The TDSUSB2 package performs measurements for USB2.0 compliance. This section contains information about the algorithms used by the application to perform each measurement.

Cross-Over Voltage for Low Speed and Full Speed Signals

You can define the Cross-Over point as the point where the Data+ line voltage crosses the Data- line voltage. The voltage value at this point is called the Cross-Over Voltage and the time value is called the Cross-Over time.

In the following figure, C1, C2, C3, C4 and C5 are called Cross-Over Points and R1, R2, R3, R4, R5, R6 and R7 are called Reference points.

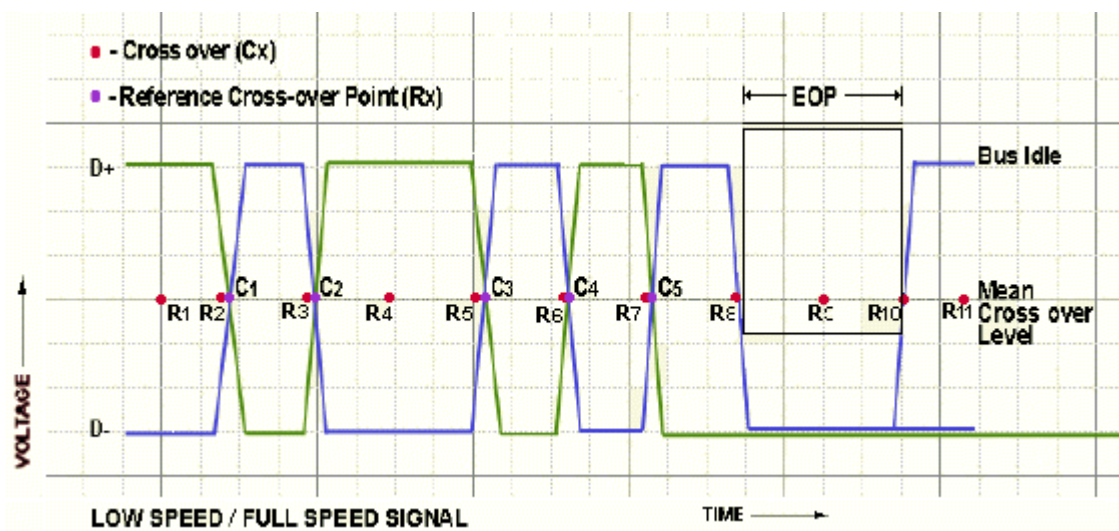

The following figure explains the interpolation technique used to find the actual Cross-Over where p1 and p2 are the adjacent data points after q2:

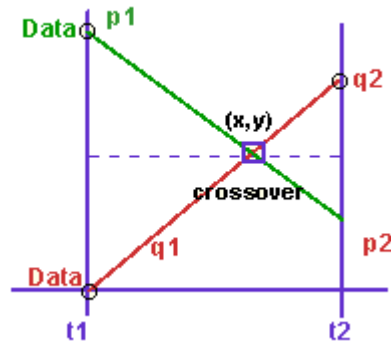

The intersection of the four voltage points p1, p2, q1, and q2 gives the Cross-Over point for Voltage level (y) and time (x). x and y coordinates are obtained by solving the following two equations:

$$(p1 - y) / (x - t1) = (p1 - p2) / (t2 - t1)$$

$$(q2 - y) / (t2 - x) = (q2 - q1) / (t2 - t1)$$

Where: p1, p2, q1, and q2 are the consecutive data points of a single-ended signal.

x and y are the Cross-Over coordinates x and y that is given by the intersection of p1, p2, q1, and q2.

t1 and t2 are the time values for the data points p1 and p2.

Cross-Over Voltage for High-Speed Signals

The Cross-Over is defined as that point where the Differential line voltage becomes zero. The voltage value at this point is called the Cross-Over Voltage and the time value is called the Cross-Over Time.

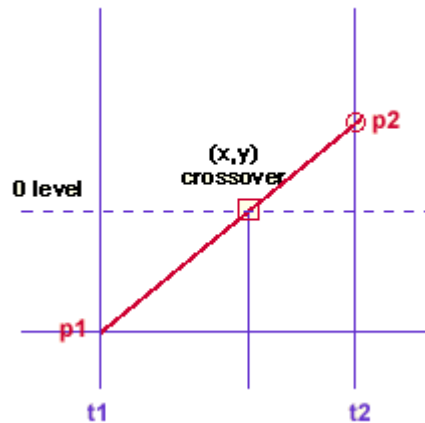

The following algorithms are used for High Speed signals for Cross-Over

$$\frac{(p2 - y)/(t2 - x) = (p2 - p1)/(t2 - t1)}{y = 0}$$

for High Speed $y=0$

If,

$$p1 \neq p2$$

$$x = (p2t1 - p1t2)/(p2 - p1)$$

If,

$$p1 = p2$$

$$x = (t1 + t2) / 2$$

Where: $p1$ and $p2$ are the consecutive data points of a single-ended signal, x and y are the coordinates of the point where the Differential line voltage becomes zero and $t1$ and $t2$ are the time values for the data points $p1$ and $p2$.

Note 1: Low Speed and Full Speed Signals are acquired with single-ended probes that enable finding the Cross-Over Voltage.

Note 2: For High Speed devices, the signal is differential, Cross-Over voltage is zero and cross-Over time is the interpolation of two data points at zero crossings.

Signal Rate

You can define the signal rate for Low or Full speed signals as the inverse of the average bit time that gives the transmission rate of the USB2.0 signal. For high speed signals, the signal rate is defined as the inverse of the average bit time that gives the transmission rate of the Test_Packet.

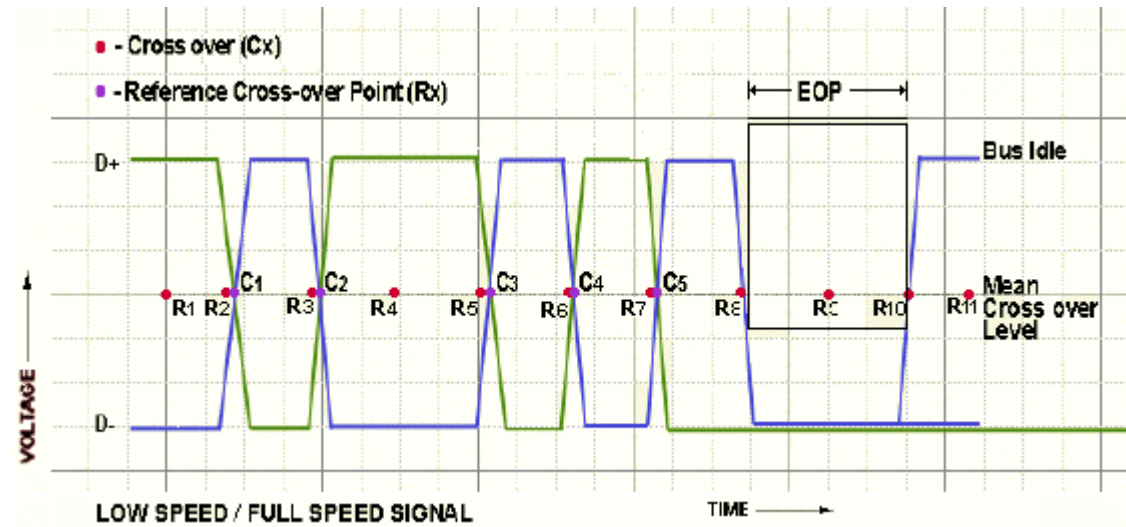

The average signal rate is the calculated average of number of bits divided by sum of all periods.

$$AverageSignalRate = \sum_{i=0}^{lastcrossover} \frac{SumWeights}{SumPeriod}$$

$$BitTime = C2 - C1$$

Where: SumWeights is the total number of bits in the packet.

SumPeriod is the sum of all time periods between the Cross-Overs.

C1 and C2 are the Cross-Over points.

Bit time is the difference of the time values of C2 and C1.

EOP Width Calculation

You can define the EOP width for Low or Full speed signals as the width of the end-of-packet of a USB2.0 signal. For high speed signals, it is defined as the width of the end-of-packet pattern of a Test_Packet.

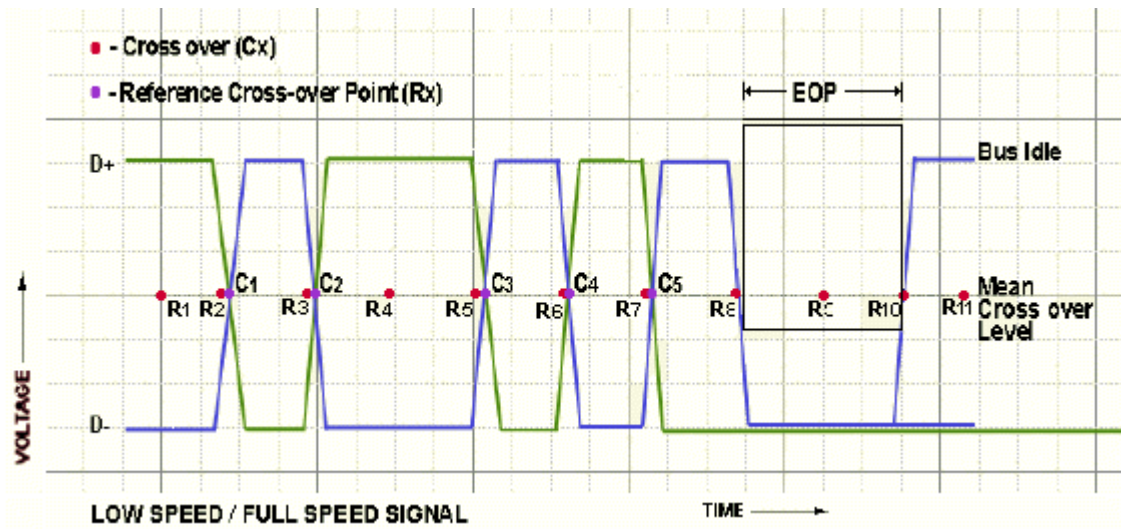

EOP Width is calculated as shown below.

$$EOPWidth = (EOP2 - EOP1)$$

Where:

EOP1 and EOP2 are the data points on a USB2.0 signal crossing the Mean Cross-Over level. The Cross-Over level is the mean value of all Cross-Overs in the USB2.0 packet.

Consecutive and Paired Jitter

You can test two types of Jitter measurements: Consecutive and Paired Jitter. Consecutive jitter measures the consecutive data bit calculated using the signal rate.

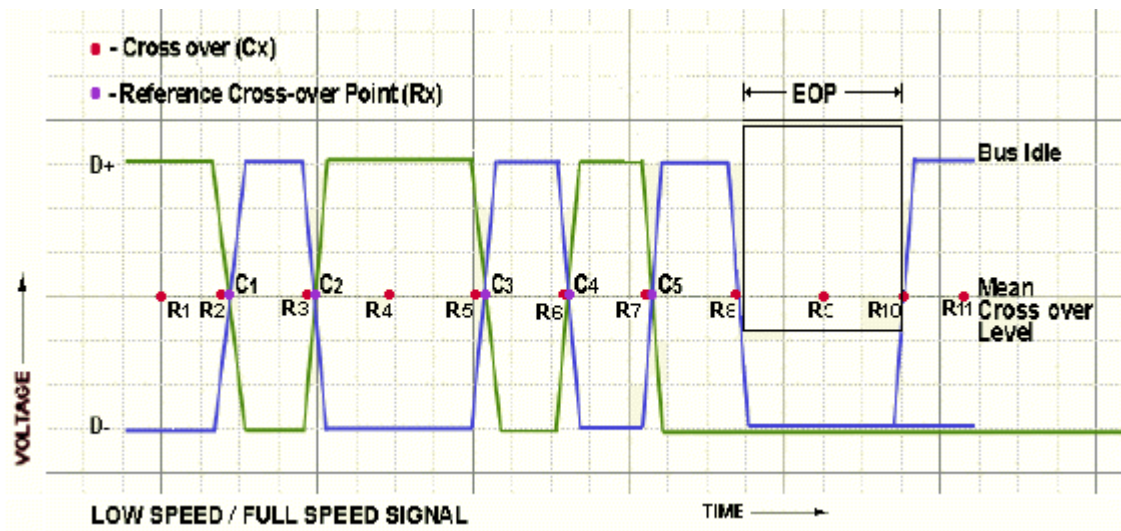

Consecutive jitter is calculated as follows.

$$\text{ConsecutiveJitter}[1] = R1 - C1$$

$$\text{ConsecutiveJitter}[2] = R2 - C2$$

$$\text{ConsecutiveJitter}[3] = R3 - C3$$

$$\text{ConsecutiveJitter}[4] = R4 - C4$$

Where: C1, C2, C3, and C4 are the Cross -Over points.

R1, R2, R3, and R4 are the reference points.

Consecutive jitter is the difference between the time values at Rx and Cx.

Consecutive jitter is calculated for all Cross-Overs of the USB2.0 signal.

Paired JK Jitter is defined as the jitter time for paired (JK next to KJ) differential data transition. Paired KJ Jitter is defined as the jitter time for paired (KJ next to

JK) differential data transition. They are calculated for all the consecutive jitters as:

$$\text{PairedJKJitter}[1] = \text{ConsecutiveJitter}[2] - \text{ConsecutiveJitter}[4]$$

$$\text{PairedKJitter}[2] = \text{ConsecutiveJitter}[1] - \text{ConsecutiveJitter}[3]$$

and so on till the last Cross-Over.

Eye Diagram

The Eye Diagram checks whether the USB signal is aligned with its corresponding eye diagram. It represents the whole signal by splicing it into a number of waveforms of unit interval (each waveform is of one bit time interval) scaled and represented on the eye masks.

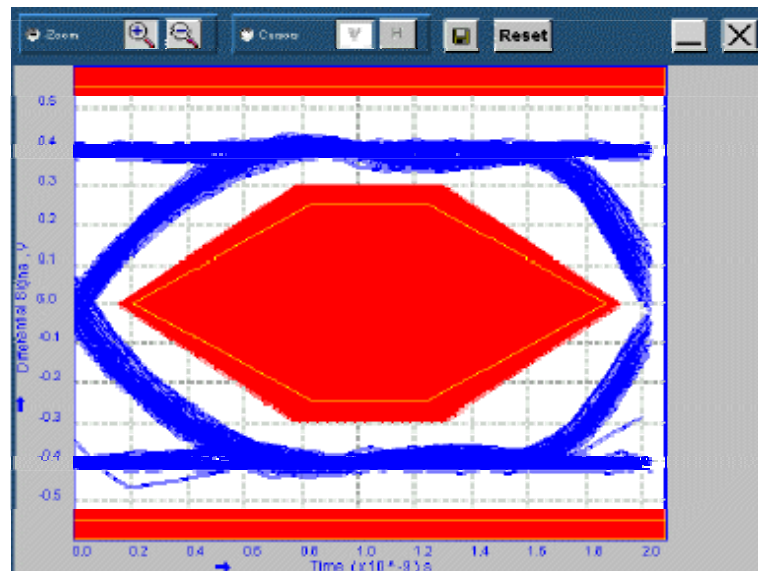

Eye Violation

An eye violation occurs when an USB signal crosses an eye mask. The results of the eye violation are PASS if the waveform does not violate the eye masks. The result is FAIL if the waveform violates the Eye Masks. The result is CONDITIONAL PASS if the waveform violates the eye mask, but is within the waiver mask.

By default, the application displays the waiver mask if the result is either CONDITIONAL PASS or FAIL. If you select the option "Always show the waiver mask in the eye diagram" in File> Preferences menu, the waiver mask is displayed irrespective of the result.

Inrush Current

Inrush Current is calculated by recording all the current values above the 100 mA current level throughout the signal. This signal is integrated to get the total charge greater than 100 mA. This is the charge in Coulombs and is calculated using the equation:

i is the current waveform above 100 mA.

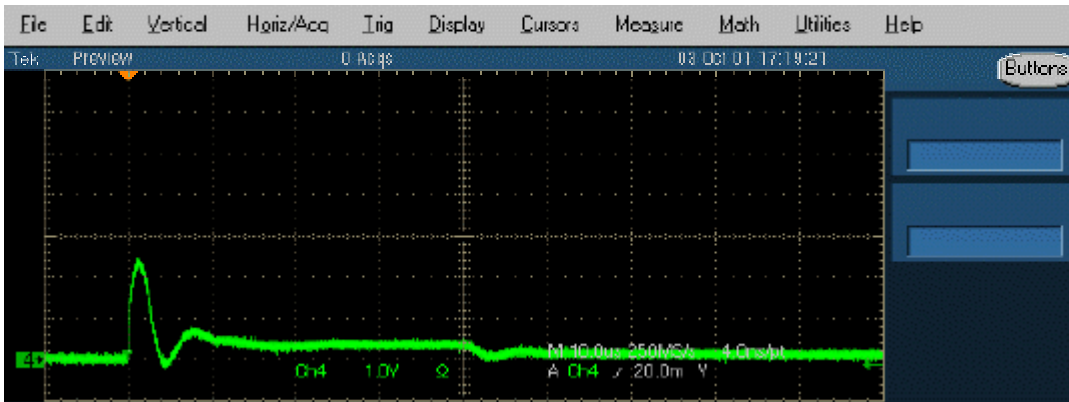

Capacitance is calculated by using the equation,

$$Q = CV$$

Where: C is the capacitance.

Q is the charge.

V is the voltage.

The supply voltage is one of the inputs to Inrush measurement.

Droop Test

Droop voltage is the difference between the V_{BUS} value when the droop load is off and the lowest voltage of the V_{BUS} value when the droop load is powered on.

$$DroopVoltage = VoltageValue_{LoadOff} - LowestVoltage_{LoadOn}$$

Receiver Sensitivity Test

You can test the Receiver sensitivity of a high speed device to respond to the particular data pattern generated by the digital signal generator. Receiver Sensitivity responds whenever the data pattern level of the voltage level is greater than 150 mV and does not respond when the voltage level is equal to or less than 100 mV below the squelch level. The application provides the procedural steps to this test.

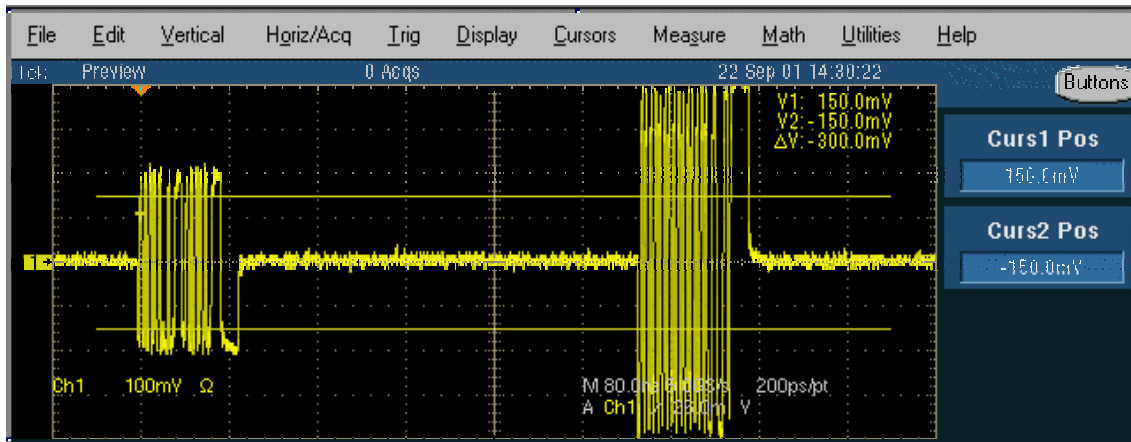

For more details, refer to the [procedural steps](#).

Chirp Test for a Device

This test examines the basic timing and voltages of both upstream and downstream ports during the speed detection protocol. To get the Chirp signal, hot-plug the unit under test (device) and measure the signaling with single-ended probes on both lines. The application analyzes data for the following:

- Reset duration
- Chirp-K amplitude
- Chirp-K duration

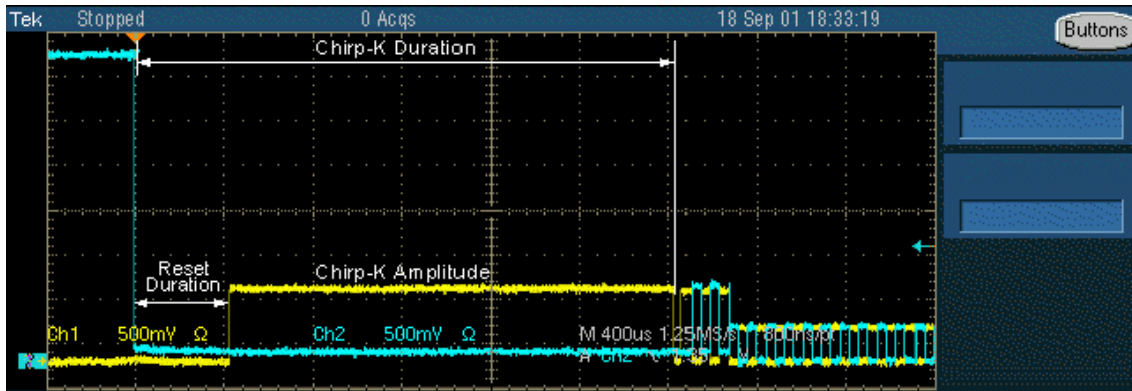

Note: There must be three K-J pairs after chirp-K that are less than 500 μ s. This is to check the response of the device. The response time must be less than 100 μ s. You can verify this manually.

Host Chirp Test

This test examines the basic timing and voltages of both upstream and downstream ports during the speed detection protocol. To get the Chirp signal, hot-plug the unit under test (Host) and measure the signaling with single ended probes on both lines. The application analyzes data for the following:

- Chirp Response Timing
- Chirp-K and Chirp-J duration

The application analyzes data for the Chirp J/K to first SOF Time.

Monotonic Property Test

This algorithm calculates the number of monotonic violations that are present from of the start of the signal to the end of packet (EOP). For the signal to be monotonic, the signal is checked from 15% to 85% of the Peak to Peak differential signal levels or user specified levels.

Monotonicity is calculated for Rising and Falling slopes as follows.

For Rising slope, $f(x)$ is a differential signal if,

$$f(x+1) \geq f(x)$$

signal is monotonic for all values of x till the last data point.

For Falling slope, $f(x)$ is a differential signal if

$$f(x+1) \leq f(x)$$

for all values of x till the last data point.

Rise Time

The Rise Time measurement is the time difference between when the VRefHi reference level is crossed and the VRefLo reference level is crossed on the rising edge of the waveform. The Rise Time algorithm uses the VRef values as the reference voltage level. Each edge is defined by the slope, voltage reference level (threshold) and hysteresis.

The application calculates this measurement using the following equation:

$$T_n^{Rise} = T_n^{Hi} - T_n^{Lo}$$

Where: TRise is the rise time,

THi+ is the VRefHi crossing on the rising edge

TLo+ is the VRefLo crossing on the rising edge

Fall Time

The Fall Time measurement is the time difference between when the VRefLo reference level is crossed and the VRefHi reference level is crossed on the falling edge of the waveform. The Fall Time algorithm uses the VRef values as the reference voltage level. The slope, voltage reference level (threshold), and hysteresis define each edge.

The application calculates this measurement using the following equation:

$$T_n^{Fall} = T_n^{Lo} - T_n^{Hi}$$

Where: TFall is the fall time,

TLo- is the VRefLo crossing on the falling edge

THi- is the VRefHi crossing on the falling edge

Packet Parameter

The algorithm calculates the SYNC field length, EOP length, and the Inter-Packet gap. The acceptable range of EOP for all transmitted packets (except SOFs) must be between 7.5 and 8.5 bits. The packet parameter algorithm calculates and verifies the EOP depending on this range.

The acceptable range of inter-packet gap should be between 88 bits to 192 bits. The SYNC field for all transmitted packets is calculated by counting the bits to check for 32-bit SYNC field. The inter-packet delay and SYNC status is calculated between the respective EOP indexes of the packets. The EOP width in time is calculated by dividing the EOP width by the signaling rate of 480 Mbps.

Oscilloscope setup details

The application sets the oscilloscope automatically to the following values:

Horizontal Scale: 400 ns

Record Length: 50 K

Vertical Scale: 200 mV

Trigger Type Pulse Width

Trigger Hold Off: 5 s

Resume

This test calculates the device/HUB resume High-speed operation, indicated by High-speed SOF packets (with 400 mV nominal amplitude) following the K state driven by the host controller. For the Host, this is the time between the falling edge of D+ and the First SOF. This should not exceed 3.0mS. To get the Suspend signal, hot-plug the unit under test (device) and measure the signaling with single-ended probes on both lines. The application analyzes data for the following:

- Resume Time
- Amplitude

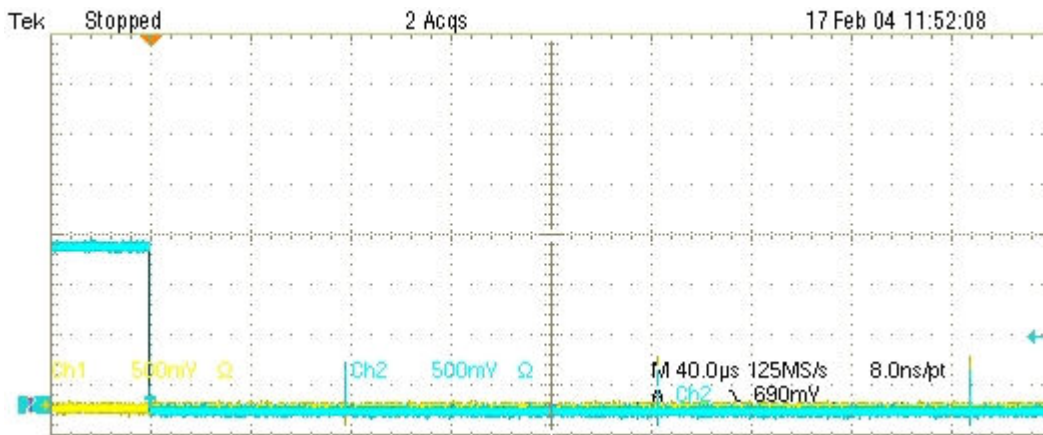

Suspend

This test calculates the time between the end of last SOF and the rising edge transition to Full-speed J state for Host / Device / Hub- upstream. This time must be between 3 ms and 3.125 ms. To get the Suspend signal, hot-plug the unit under test (device) and measure the signaling with single-ended probes on both lines. The application analyzes data for the Suspend Time.

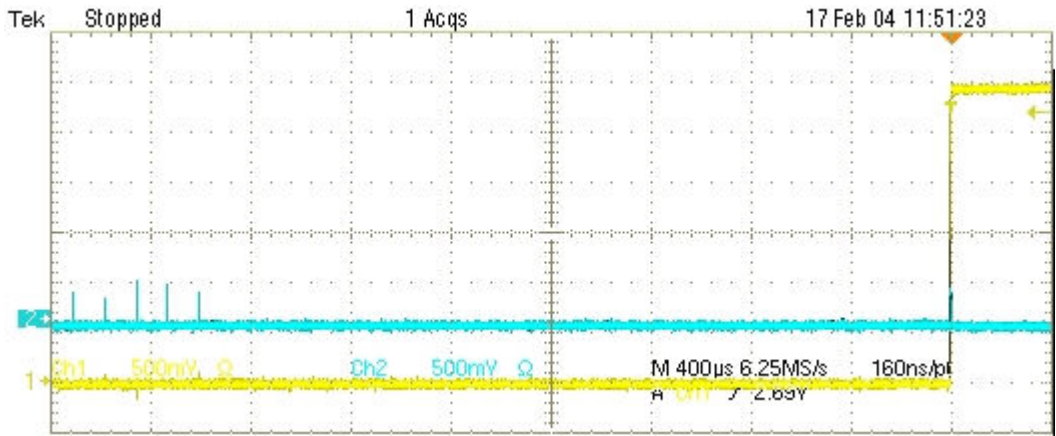

Reset from Suspend

This test calculates the time between the falling edge of D+ signal and the start of Device chirp-K for the Device/HUB upstream. This must be between 2.5 μ s and 3 ms. To get the Reset from Suspend Measurement signal, hot-plug the unit under test (device), and measure the signaling with single-ended probes on both lines. The application analyzes data for the Reset From Suspend Time.

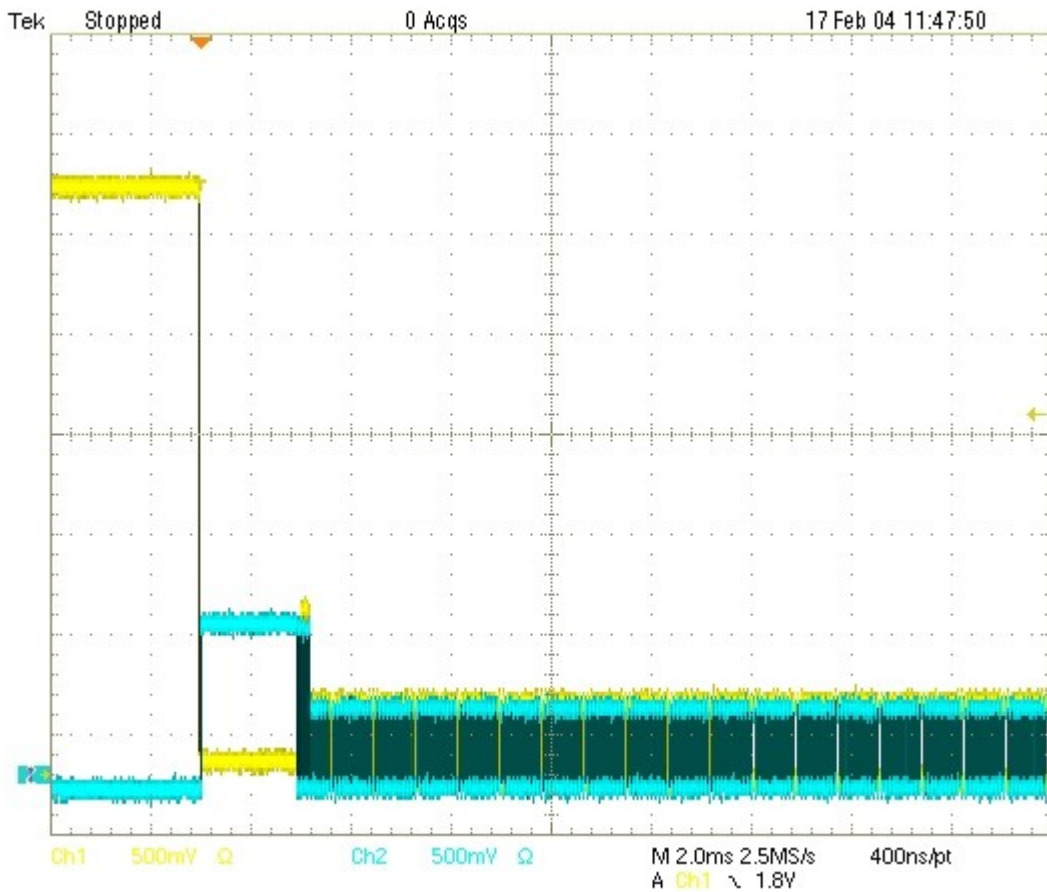

Reset from High Speed

This test calculates the time between the beginning of the last SOF and before the reset and the beginning of Chirp-K for Device and HUB upstream. This must be between 3.1 ms and 6 ms. To get the Reset from High-Speed Measurement signal, hot-plug the unit under test (device) and measure the signaling with single-ended probes on both lines. The application analyzes data for Reset From High Speed Time.

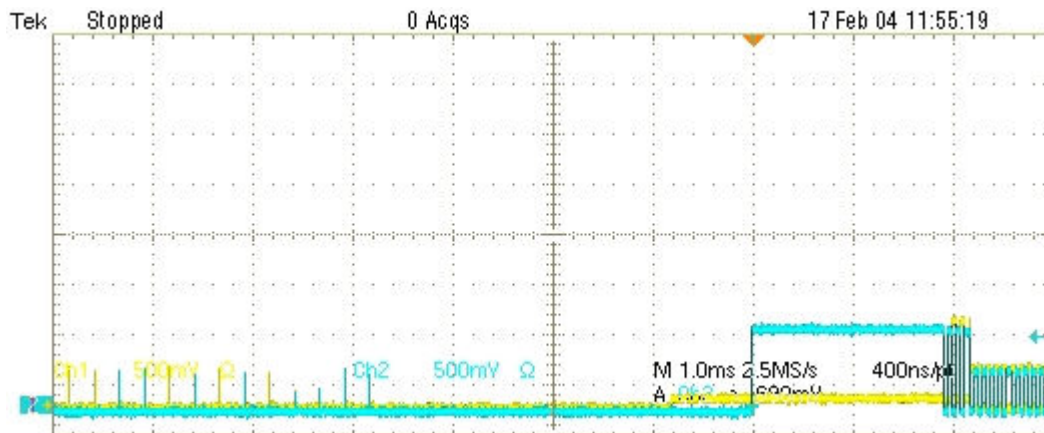

Equipment Setup for Tests

Low Speed Downstream Signal Quality Host Equipment Setup

To set up the equipment for Low Speed Downstream Signal Quality test, follow these steps:

1. Connect a cable between the A receptacle from the Inrush test section of the test fixture and the USB device.
2. Connect Ch1 of the D+ probe to the D+ pins on the Inrush section of the test fixture.
3. Connect Ch2 of the D- probe to the D- pins on the Inrush section of the test fixture.
4. Use the connectors to connect the A pin dongle from the Inrush section of the test fixture to any port of the unit under test (host or PC).
5. Select the measurement and select the  command button to run the application.
6. Select OK after acquiring a waveform. Verify that it is a correct waveform.

If the signal is clipped, follow these steps to increase the vertical scale:

1. In the oscilloscope menu, select Vertical>Vertical Setup to display the Channel screen.
2. In the Scale field, increase the vertical scale values until the waveform is completely displayed on screen.

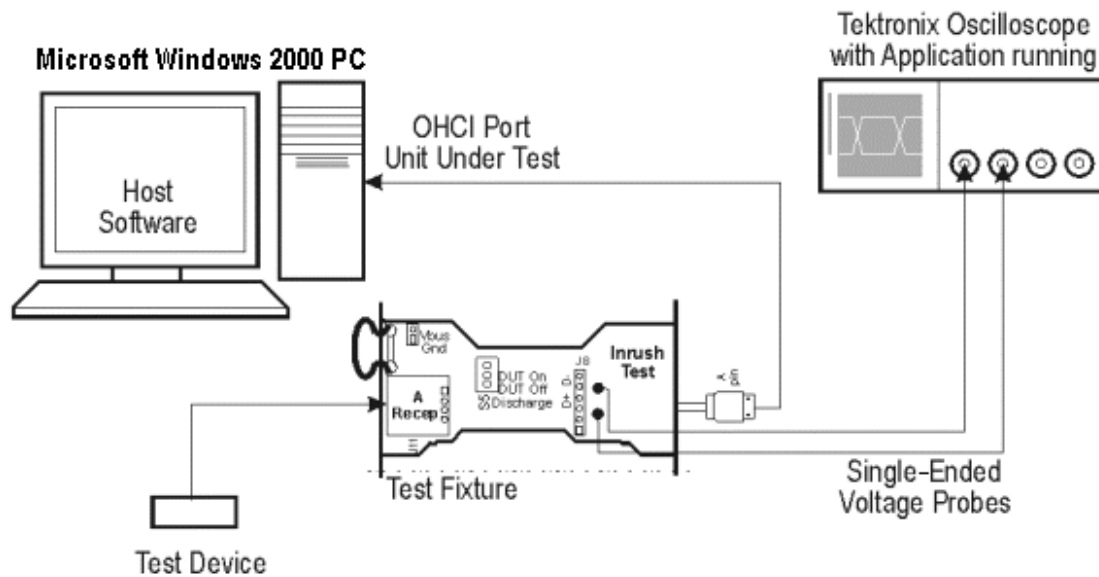



Figure 120: Equipment setup for Low Speed Downstream Signal Quality Host

Low Speed Signal Quality for HUB Downstream

To set up the equipment for Low Speed Signal Quality (hub) test, follow these steps:

1. Connect the A plug dongle from the Inrush section of the test fixture to the port of the unit under test (hub).
2. Connect the low speed test device to the A receptacle on the Inrush section of the test fixture. Keep the Discharge switch always in the ON position.
3. Connect Ch1 of the D+ probe to the D+ pins on the Inrush section of the test fixture.
4. Connect Ch2 of the D- probe to the D- pins on the Inrush section of the test fixture.
5. Configure the measurement and select the  command button to run the application.
6. Select OK after acquiring a waveform. Verify that it is a correct waveform.

If the signal is clipped, follow these steps to increase the vertical scale:

1. In the oscilloscope menu, select Vertical>Vertical Setup to display the Channel screen.
2. In the Scale field, increase the vertical scale values until the waveform is completely displayed on screen.

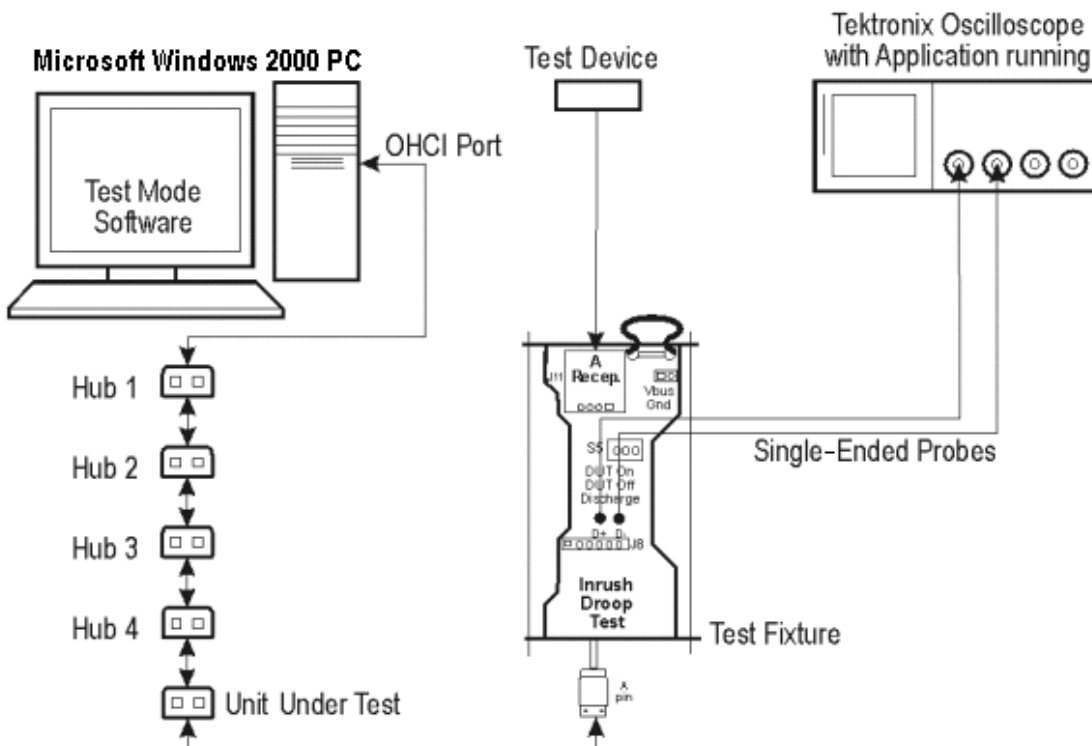



Figure 121: Equipment setup for Low Speed Signal Quality for HUB Downstream

Full Speed Signal Quality HUB Downstream Setup

To set up the equipment for Full Speed Signal Quality Downstream test, follow these steps:

1. Set the S6 switch to the Init position.
2. Use the adapters to connect the A receptacle from Device SQ test section (marked DUT) of the test fixture to the USB2.0 Low Speed device.
3. Connect Ch1 of the D+ probe to the D+ pins on the Device SQ section of the test fixture.
4. Connect Ch2 of the D- probe to the D- pins on the Device SQ section of the test fixture.
5. Connect the Init port of the Device SQ section of the test fixture to any port of the unit under test (hub) using the USB cable.
6. Select the measurement and select the  command button to run the application.
7. Select OK after acquiring a waveform. Verify that it is a correct waveform.

Note: Make sure the acquired signal is a valid waveform.

If the signal is clipped, follow these steps to increase the vertical scale:

1. In the oscilloscope menu, select Vertical>Vertical Setup to display the Channel screen.
2. In the Scale field, increase the vertical scale values until the waveform is completely displayed on screen.

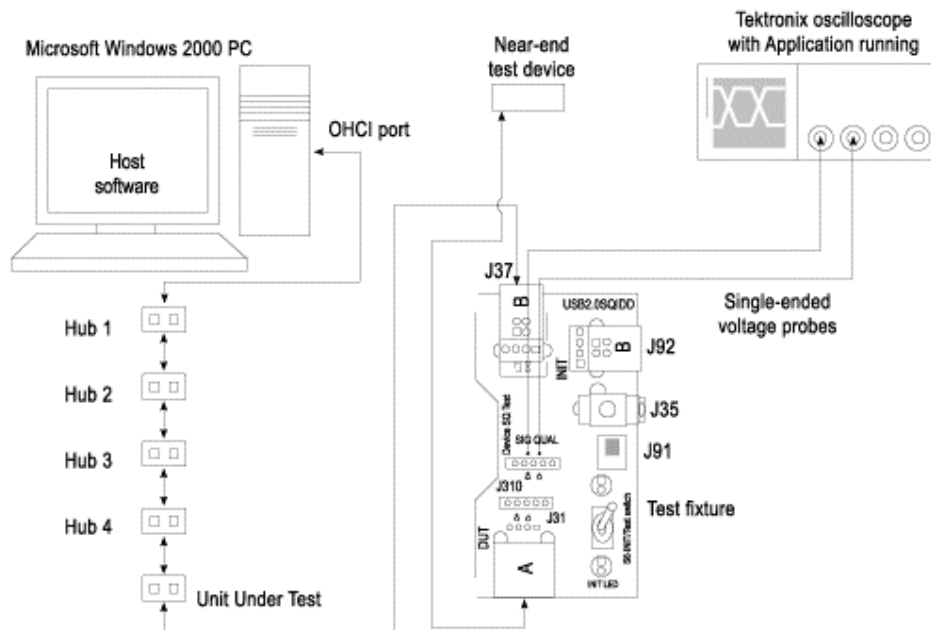



Figure 122: Equipment setup for Full Speed Signal Quality HUB Downstream

Full Speed Downstream Host Equipment Setup

To set up the equipment for Full Speed Downstream (host) test, follow these steps:

1. Set the S6 switch to the Init position.
2. Connect the A receptacle from Device SQ test section (marked DUT) of the test fixture to the hub system. Connect the Full Speed test device to Hub 5.
3. Connect Ch1 of the D+ probe to the D+ pins on the Device SQ section of the test fixture.
4. Connect Ch2 of the D- probe to the D- pins on the Device SQ section of the test fixture.
5. Use the standard USB cable to connect the Device SQ section of test fixture to the test port of the unit under test (host).
6. Select the measurement and select the  command button to run the application.
7. Select OK after acquiring a waveform. Verify that it is a correct waveform.

If the signal is clipped, follow these steps to increase the vertical scale:

1. In the oscilloscope menu, select Vertical>Vertical Setup to display the Channel screen.
2. In the Scale field, increase the vertical scale values until the waveform is completely displayed on screen.

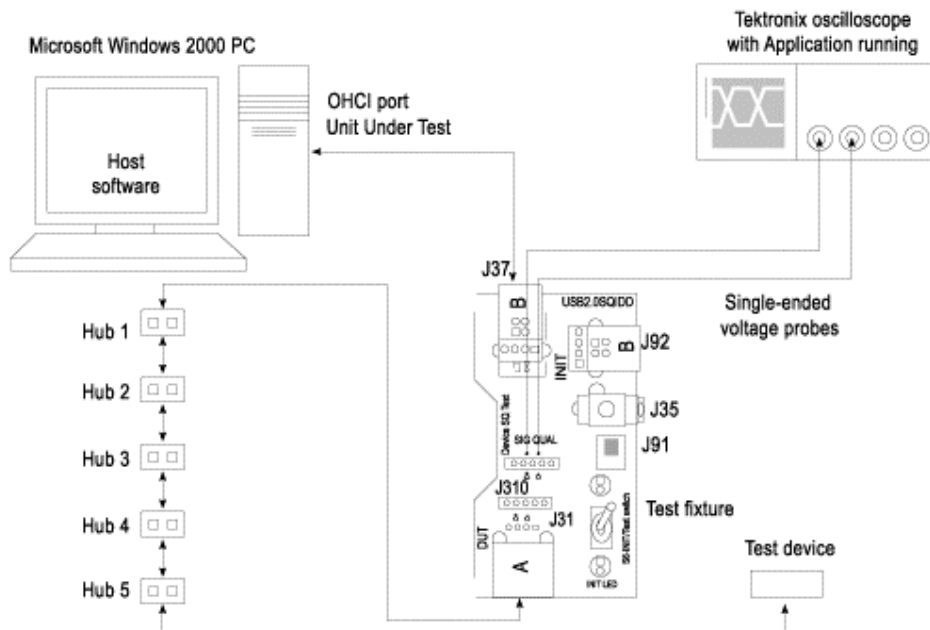



Figure 123: Equipment setup for Full Speed Downstream Host

Full Speed Upstream Signal Quality Setup

To set up the equipment for Full Speed Upstream test, follow these steps:

1. Use the A receptacle to connect the USB unit under test (device) to the Inrush section of the test fixture.
2. Connect the Qualifier device to the Adjacent Trigger and Droop section of the test fixture as shown in the following figure.
3. Connect Ch1 of the D+ probe to the D+ pins on the Inrush section of the test fixture.
4. Connect Ch2 of the D- probe to the D- pins on the Inrush section of the test fixture.
5. Connect the D+ (D- for Low speed) pin of the Adjacent Trigger and Droop Section of the test fixture to Ch3 as shown in the following figure.
6. Use the connectors to connect the A pin dongle from the Adjacent Trigger and Droop section of the test fixture to one port of Hub 5. Use the A pin dongle from the Inrush Droop section of the test fixture to another port of Hub 5.
7. Select the measurement and select the  command button to run the application.
8. Select OK after acquiring a waveform. Verify that it is a correct waveform.

Note: Use the standard USB cables to connect between the hubs. Keep the Discharge switch in the Inrush Droop section in the ON position.

If the signal is clipped, follow these steps to increase the vertical scale:

1. In the oscilloscope menu, select Vertical>Vertical Setup to display the Channel screen.
2. In the Scale field, increase the vertical scale values until the waveform is completely displayed on screen.

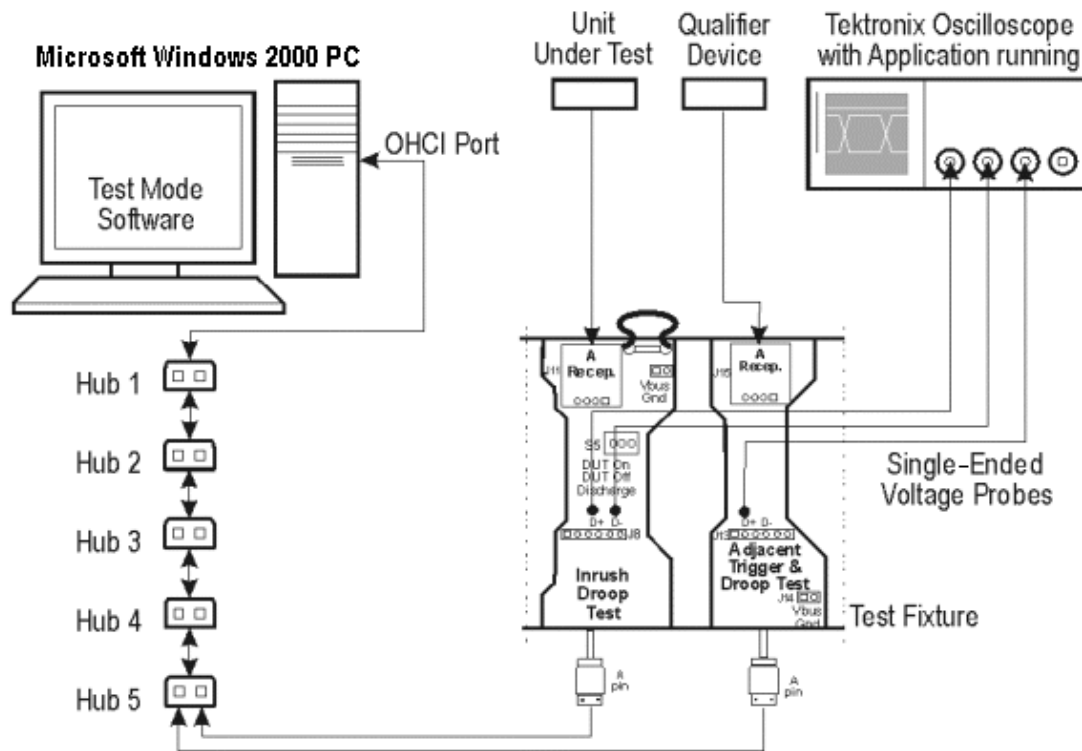



Figure 124: Equipment setup for Full Speed Upstream testing

High Speed Device Signal Quality Setup

To set up the equipment for the High Speed Signal Quality test, follow these steps:

1. Set the S6 switch to the Init position.
2. Connect the standard USB cable between the Device SQ Init port and the host port.
3. Connect the A receptacle (marked DUT) from the Device SQ test port of the test fixture to the unit under test (device).
4. Configure the measurement and select the  command button to run the application.
5. Place the device in the test mode Test_Packet from the host controller.
6. Set the S6 switch to the test position to isolate the unit under test while maintaining the bus power.
7. Select OK after acquiring a waveform. Verify that it is a correct waveform.

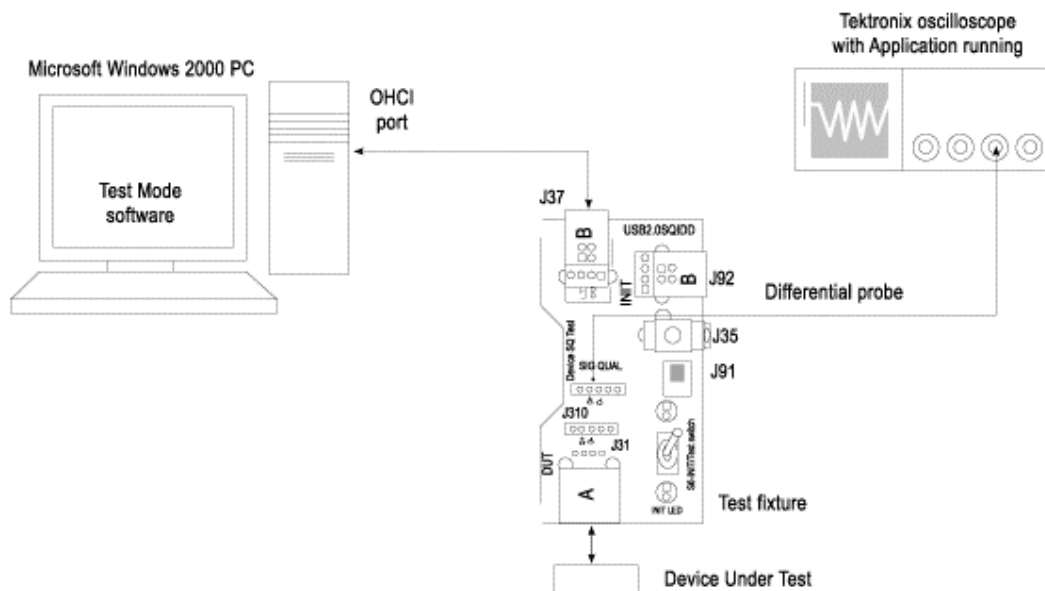



Figure 125: Equipment setup for High Speed Device testing

Chirp Test Equipment Setup

The section used for this device test is Device SQ in the test fixture. To set up the equipment for Chirp test, follow these steps:

1. Set the S6 switch to the Init position.
2. Use a standard USB cable with an A plug on one end and B plug on the other end. Connect one end of the cable to the B socket on the Init port of Device SQ section and the other end to the host port A socket.
3. Connect the A receptacle from the Device SQ test port to the unit under test (device).
4. Connect the single-ended probes of the oscilloscope to the D+ and D– pins.
5. Select the measurement and select the  command button to run the application.
6. Disconnect and connect the unit under test (device) to the port and observe the chirp signal on the oscilloscope.
7. Select OK after acquiring a waveform. Verify that it is a correct waveform.

***Note:** To avoid false triggering for the chirp signals while operating the test fixture, it is recommended that you place the switch in the Init position and connect the unit under test. This disables the switch bounce to the trigger.*

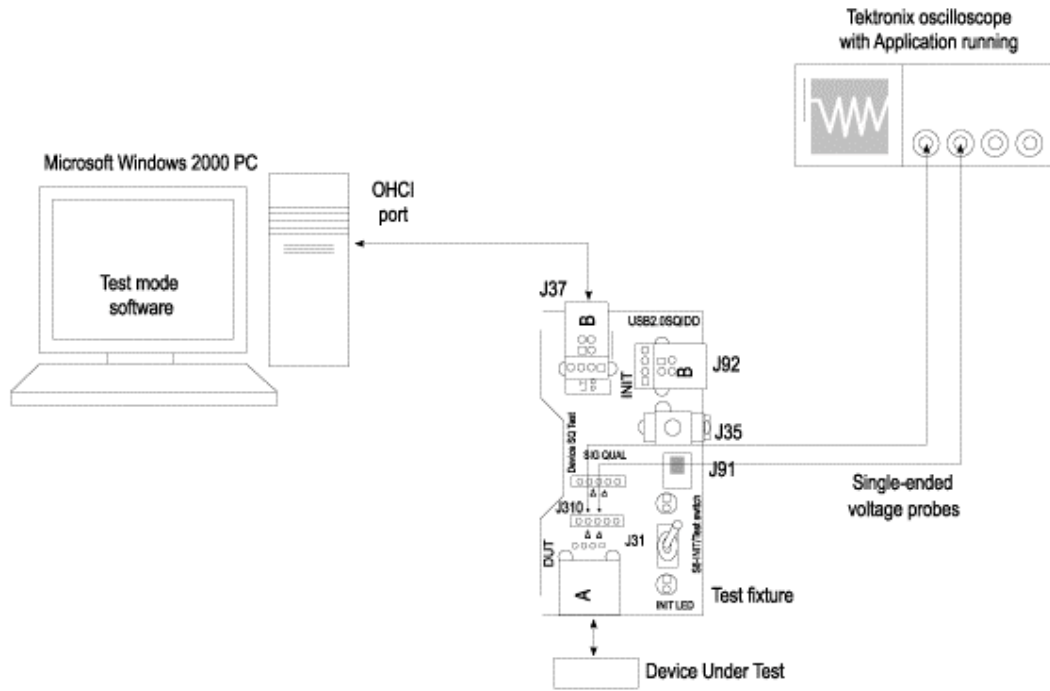

Figure 126: Equipment setup for Chirp Test

Receiver Sensitivity Setup

To set up the equipment for Receiver Sensitivity test, follow the procedural steps as given below in the application.

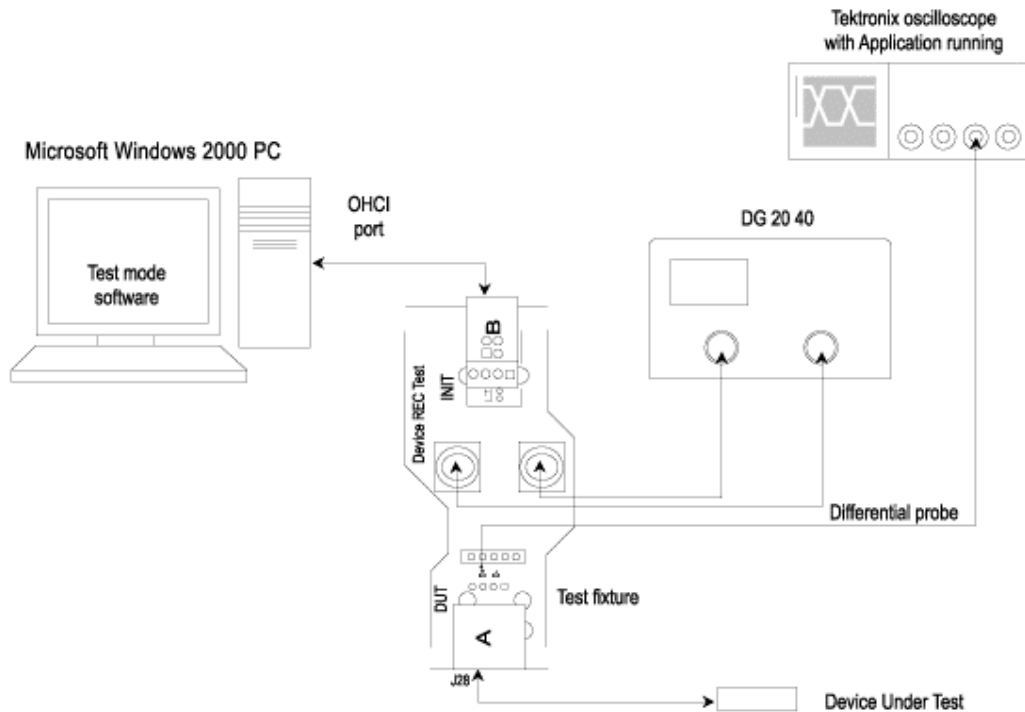

Figure 127: Equipment setup for Receiver Sensitivity Test

Procedural steps

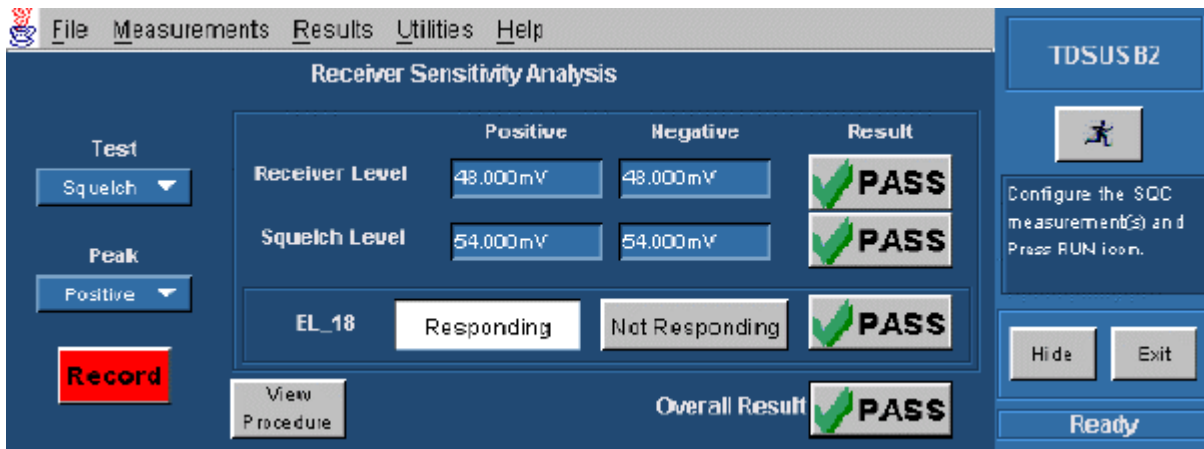
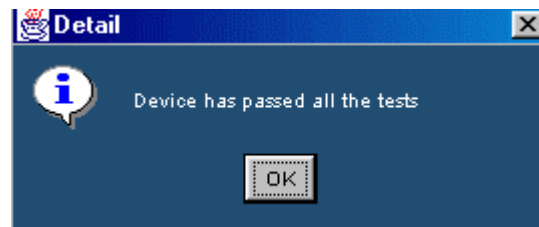
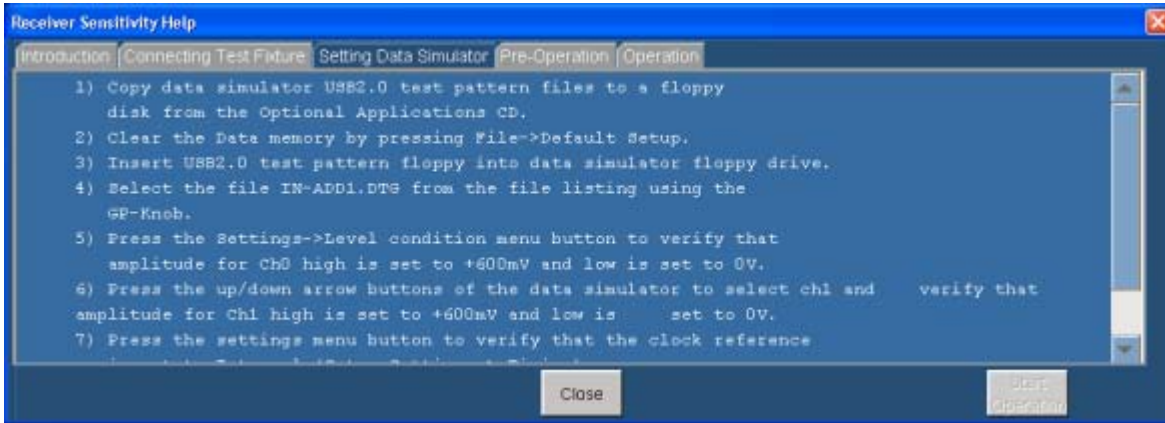
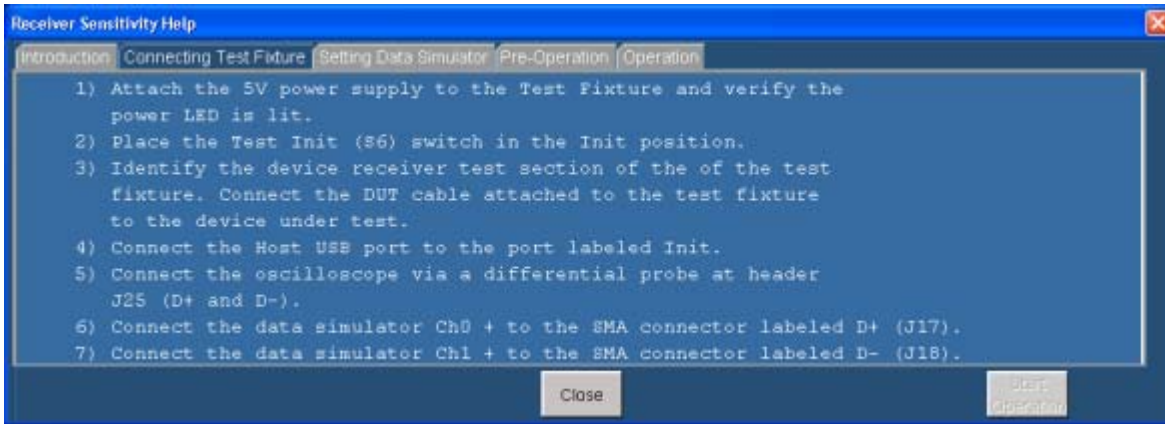
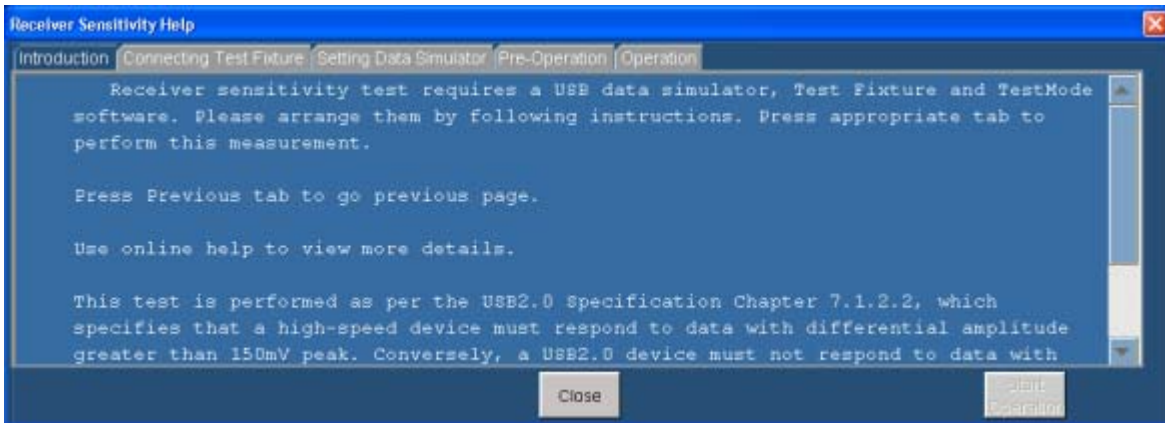
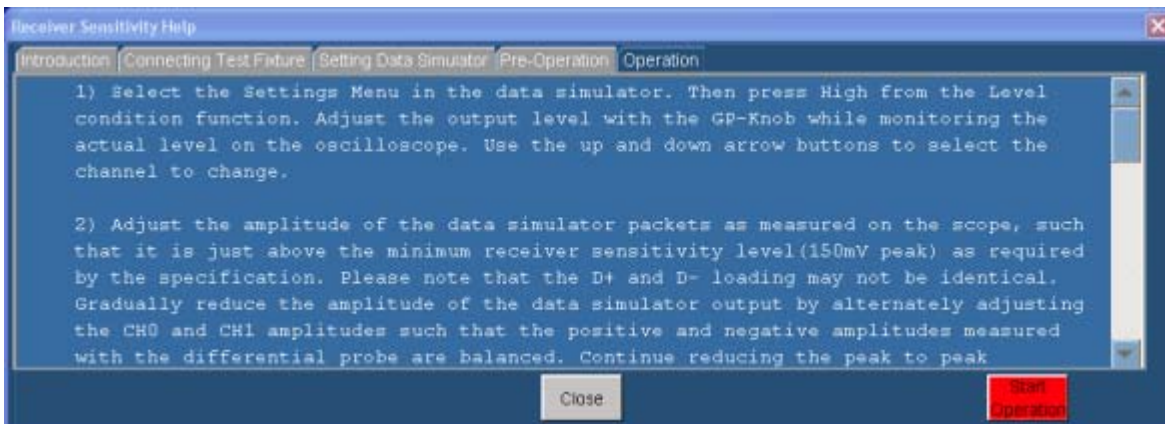
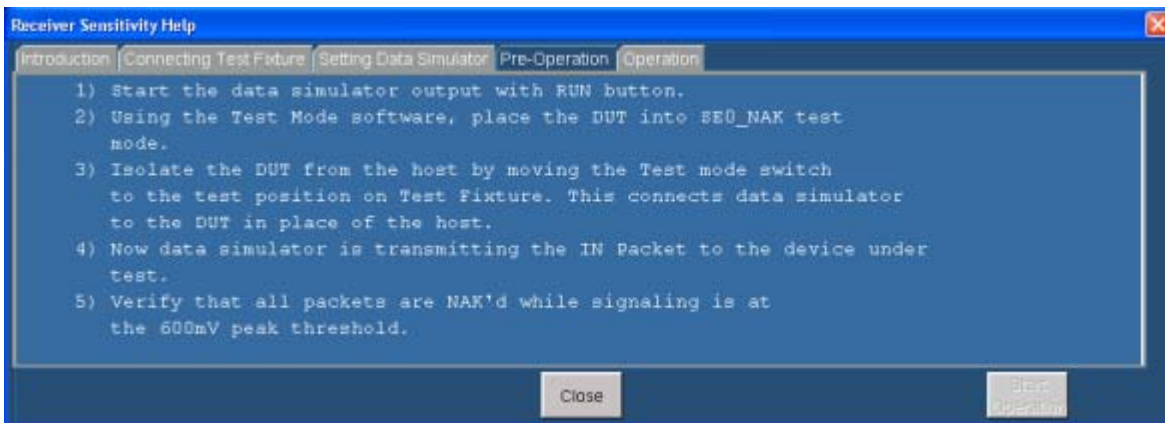

Figure 128: Receiver Sensitivity analysis

Select View Procedure to view the procedural steps. Click the Overall Result to display the following figure:







Inrush setup

To set up the equipment for Inrush test, follow these steps:

1. Use the dongle on the Inrush section of the test fixture to connect it to the host system.
2. Connect the current probe between the V_{BUS} loop wire on the Inrush section on the Test fixture and Ch1 of the oscilloscope.
3. Select the measurement and select the  command button to run the application.
4. Connect the unit under test to the A Receptacle of the Inrush section of the test fixture and observe the Inrush current signal.
5. Select OK after acquiring a waveform. Verify that it is a correct waveform.

Note: To avoid the triggering of Inrush signals and false inrush current by the discharge switch, place the inrush discharge switch in the ON position and hot-plug the unit under test (device). If a valid Inrush signal is not acquired, use the cursor mode in File> Preferences or setup the oscilloscope to get a valid waveform.

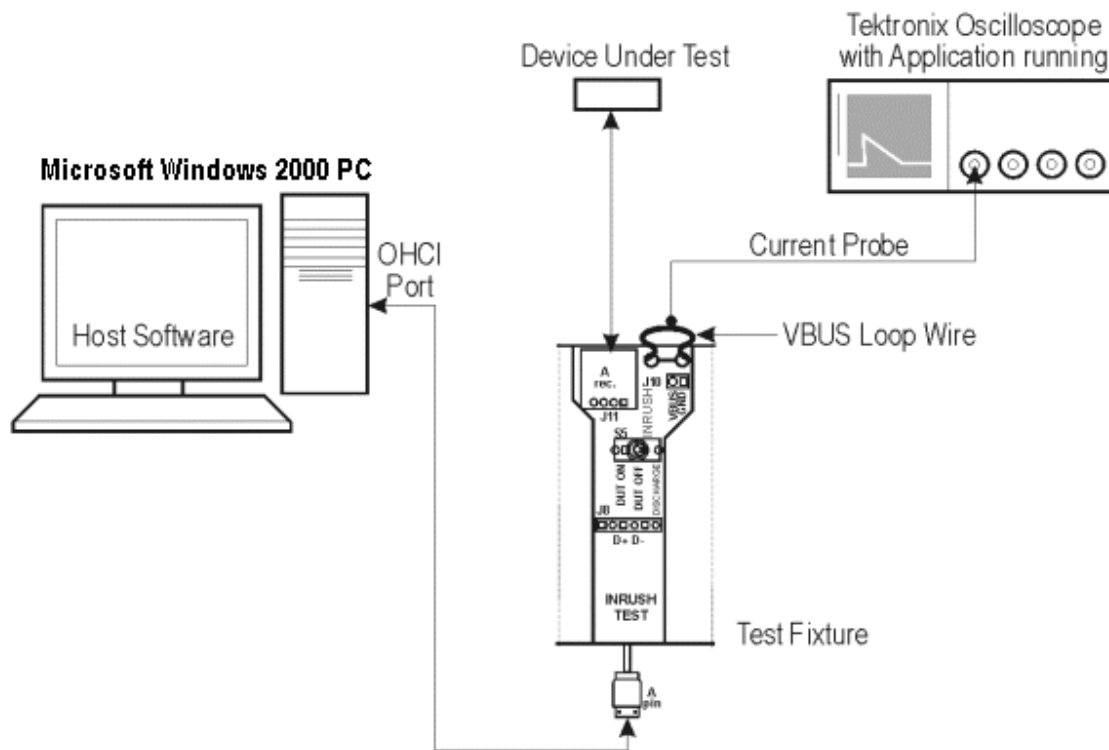

Figure 129: Equipment setup for Inrush test

Resume Test Equipment Setup

To set up the Device SQ in the test fixture for the Resume test, follow these steps:

1. Set the S5 switch to the Init position.
2. Use a standard length of the USB cable with an A plug on one end and a B plug on the other end. Connect one end of the cable to the B socket on the Init port of the Device SQ section and the other end to the host port A socket.
3. Connect the A receptacle from the Device SQ test port to the unit under test (device).
4. Connect the single-ended probes of the oscilloscope to the D+ and D- pins.
5. Select the Resume measurement in the application, configure its options and select the Run button to run the application.
6. Select OK after acquiring a waveform. Verify that it is a correct waveform.

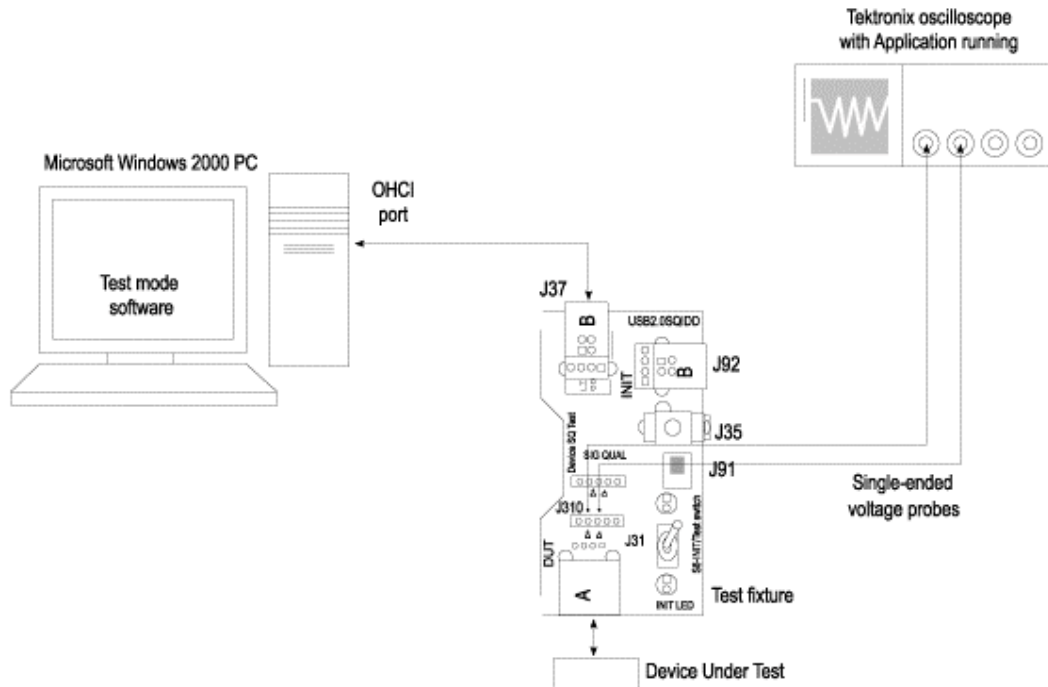

Figure 130: Equipment setup for Resume test

Reset from Suspend Test Equipment Setup

To set up the Device SQ in the test fixture for the Reset from Suspend test, follow these steps:

1. Set the S6 switch to the Init position.
2. Use a standard length of the USB cable with an A plug on one end and a B plug on the other end.
3. Connect one end of the cable to the B socket on the Init port of the Device SQ section and the other end to the host port A socket.
4. Connect the A receptacle from the Device SQ test port to the unit under test (device).
5. Connect the single-ended probes of the oscilloscope to the D+ and D- pins.
6. Select the Reset from Suspend measurement from the application, configure its options, and select the Run button to run the application.
7. Select OK after acquiring a waveform. Verify that it is a correct waveform.

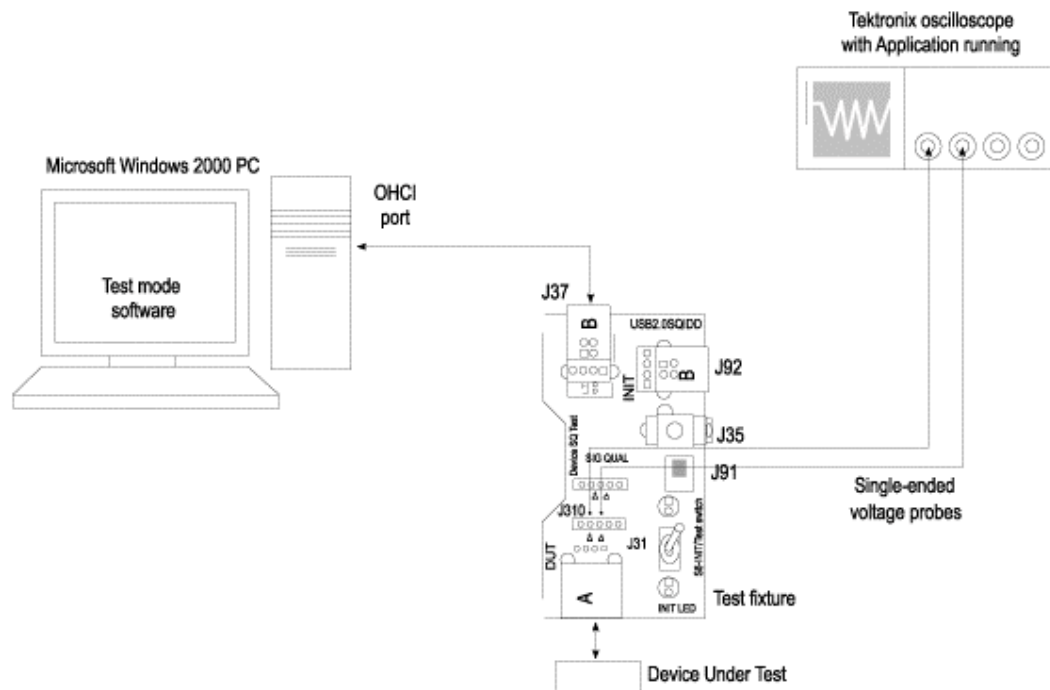

Figure 131: Equipment setup for Reset from Suspend test

Suspend Test Equipment Setup

To set up the Device SQ in the test fixture for the Suspend test, follow these steps:

1. Set the S6 switch to the Init position.
2. Use a standard length of USB cable with an A plug on one end and a B plug on the other end.
3. Connect one end of the cable to the B socket on the Init port of the Device SQ section and the other end to the host port A socket.
4. Connect the A receptacle from the Device SQ test port to the unit under test (device).
5. Connect the single-ended probes of the oscilloscope to the D+ and D– pins.
6. Select the Suspend measurement, configure its options and select the Run button to run the application.
7. Select OK after acquiring a waveform. Verify that it is a correct waveform.

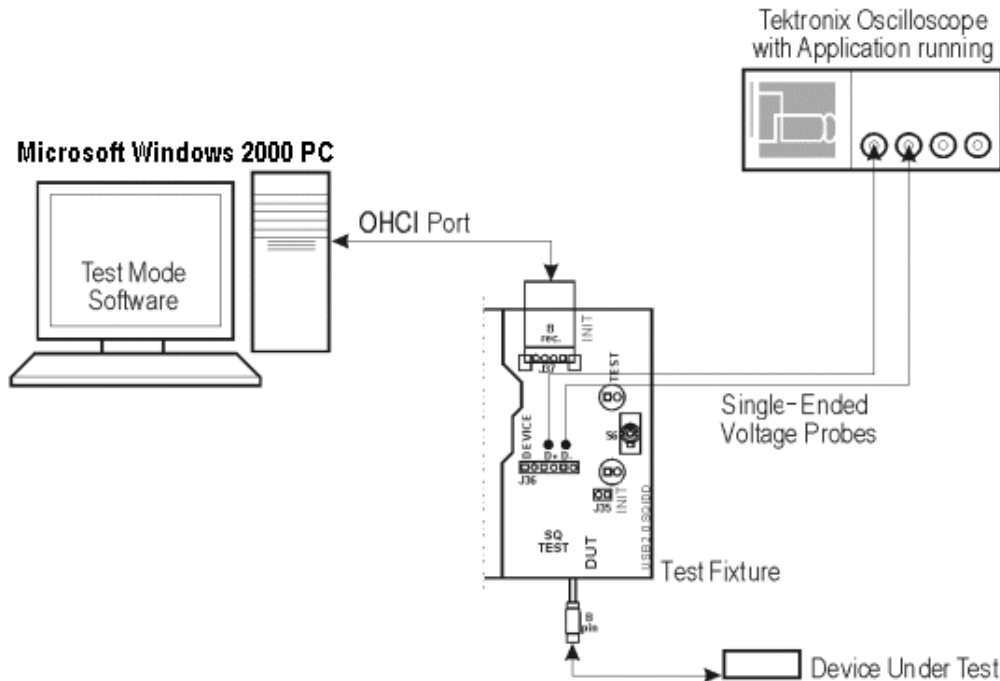

Figure 132: Equipment setup for Suspend test

Reset from High Speed Test Equipment Setup

To set up the Device SQ in the test fixture for the Reset from High Speed test, follow these steps:

1. Set the S6 switch to the Init position.
2. Use a standard length of the USB cable with an A plug on one end and a B plug on the other end.
3. Connect one end of the cable to the B socket on the Init port of the Device SQ section and the other end to the host port A socket.
4. Connect the A receptacle from the Device SQ test port to the unit under test (device).
5. Connect the single-ended probes of the oscilloscope to the D+ and D- pins.
6. Select the Reset from High Speed from the application, configure its options and select the Run button to run the application.
7. Select OK after acquiring a waveform. Verify that it is a correct waveform.

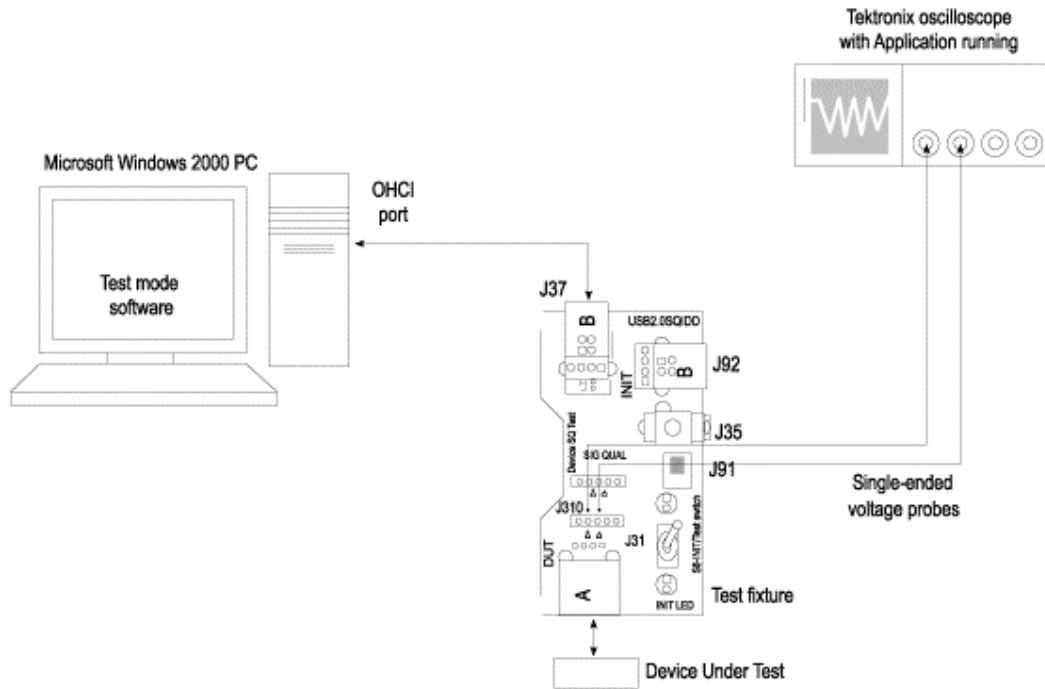

Figure 133: Equipment setup for Reset from High Speed test

Packet Parameter Test Equipment Setup

Test Fixture Setup

To set up the test fixture, follow these steps:

1. Set the S5 switch to the Init position.
2. Connect the standard USB cable between the Device SQ Init port and the host port.
3. Connect the A receptacle (marked DUT) from the Device SQ test port to the B receptacle device.
4. Apply the power to the test fixture.
5. Apply the power to the DUT.
6. Attach the differential probe near the device connector on the test fixture.

Set up the Oscilloscope for High Speed Host

1. Select the measurement and run the application. The application automatically sets the oscilloscope parameters (Horizontal, Vertical, and Trigger) and displays the message, "Press OK when correct waveform is acquired". You can see the SOFs on the oscilloscope screen.
2. If you are not able to acquire the waveform automatically, perform Autosetup in the oscilloscope to display the SOF.
3. If your DUT is EL_21, EL_23, EL_25, select the Single Step Set Feature option from the HS electrical test tool.
4. If your DUT is EL_22, select the Step button in the HS electrical test tool to acquire the waveform as shown in the following figure:

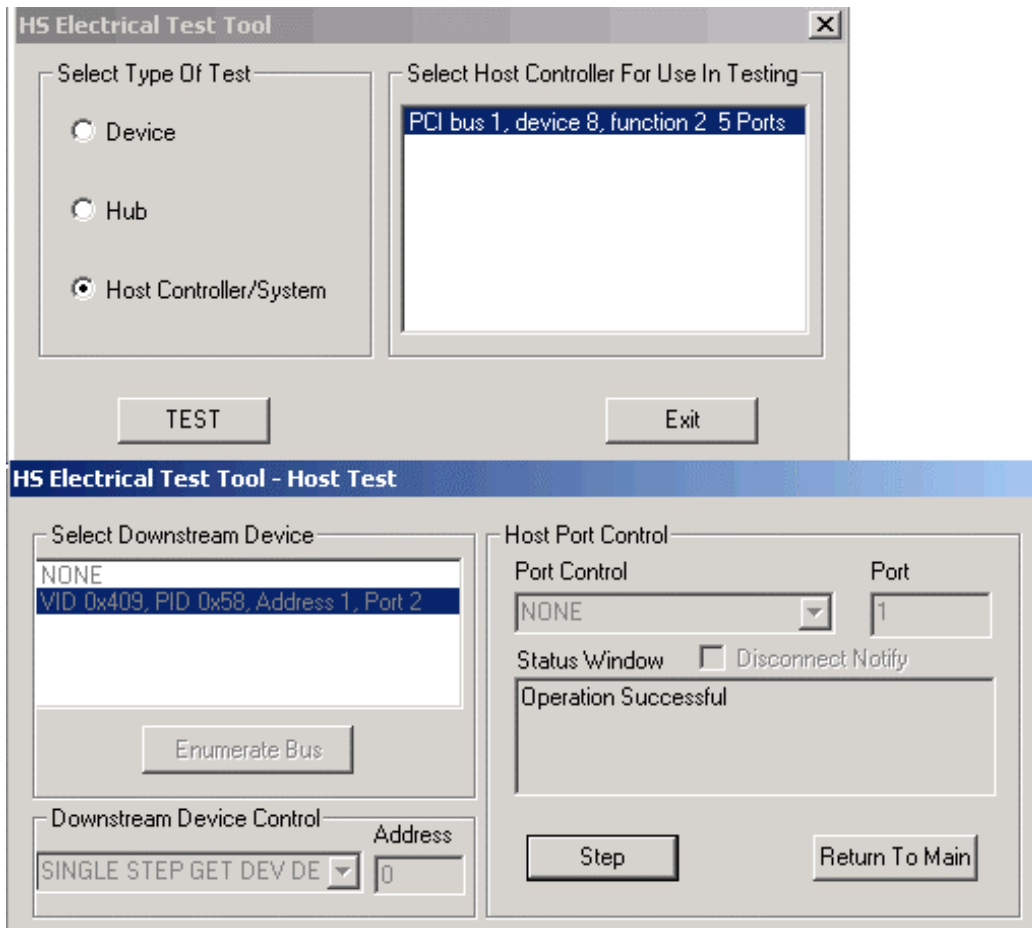

Figure 134: Setting the trigger level

You can use the application to perform the following measurements:

- High Speed Host: EL_21, EL_23, EL_25 (EOP/II-InterPacketI&II)
 - a. Complete procedures 1 and 2 to set up the test fixture and the oscilloscope.
 - b. The oscilloscope acquires and displays the waveform as shown in the following figure.
 - c. Press OK when correct waveform is acquired.
 - d. The application measures the synchronous bits (32) of the first and second packets. This is EL_21.
 - e. The application measures the EOP of the second packet (8bits). This is EL_25. As the signal is differential, the EOP can be a positive or a negative pulse.
 - f. The application measures the inter-packet gap of the first two packets (88-192 bits). This is EL_23 as shown in the following figure:

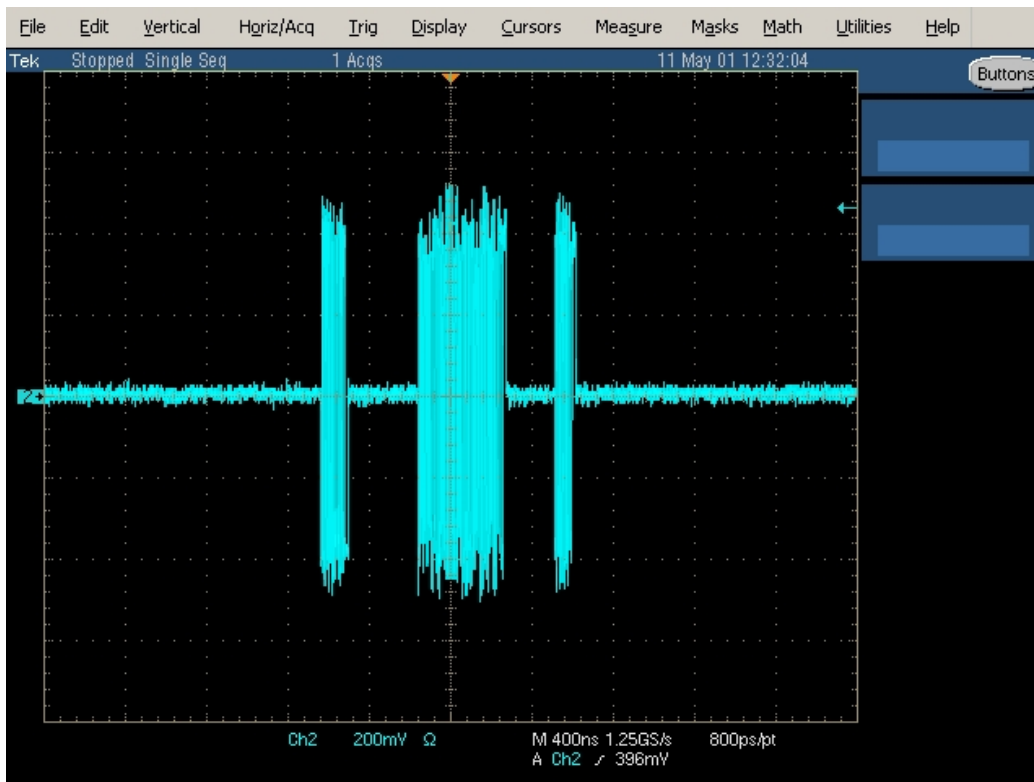

Figure 135: Measuring EL_23

- High Speed Host: EL_22 (InterPacketII&III)
 - a. Complete procedures 1 and 2 to set up the test fixture and the oscilloscope.
 - b. Select the Step button in the HS Electrical Test Tool.
 - c. The oscilloscope acquires and displays the waveform as shown in the following figure:



Figure 136: Acquiring the waveform

- d. Press OK when correct waveform is acquired.

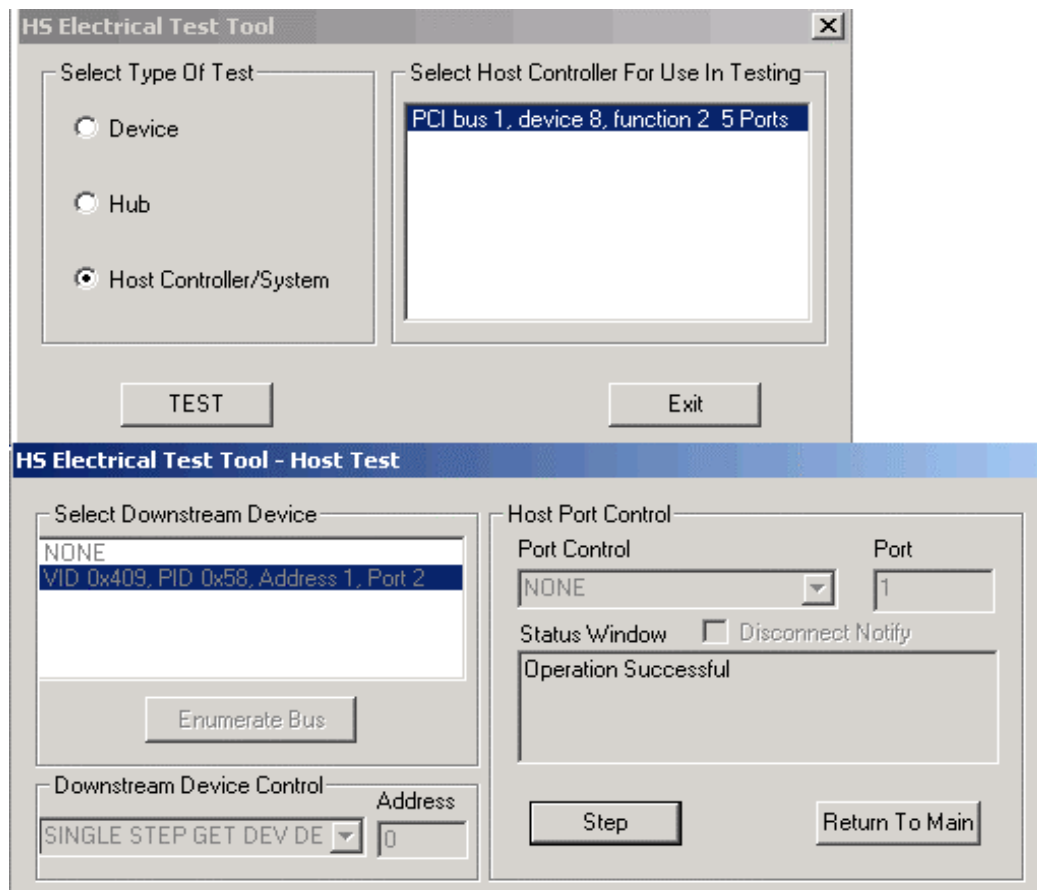

Figure 137: Setting the trigger level

- e. The application displays the waveform.
- f. The application measures the inter packet gap of the second and the third packet (88-192 bits). This is EL_22.
- High speed Host: EL_55 (SOF-EOP)
 - a. Complete the procedure 1.
 - b. Run the test mode software and select the Host option.
 - c. Select the Enumerate button in the HS electrical test tool to identify the device connected to the host controller.
 - d. Select the measurement and run the application. The application automatically sets the oscilloscope parameters (Horizontal, Vertical, and Trigger). You can see the SOFs on the oscilloscope screen.

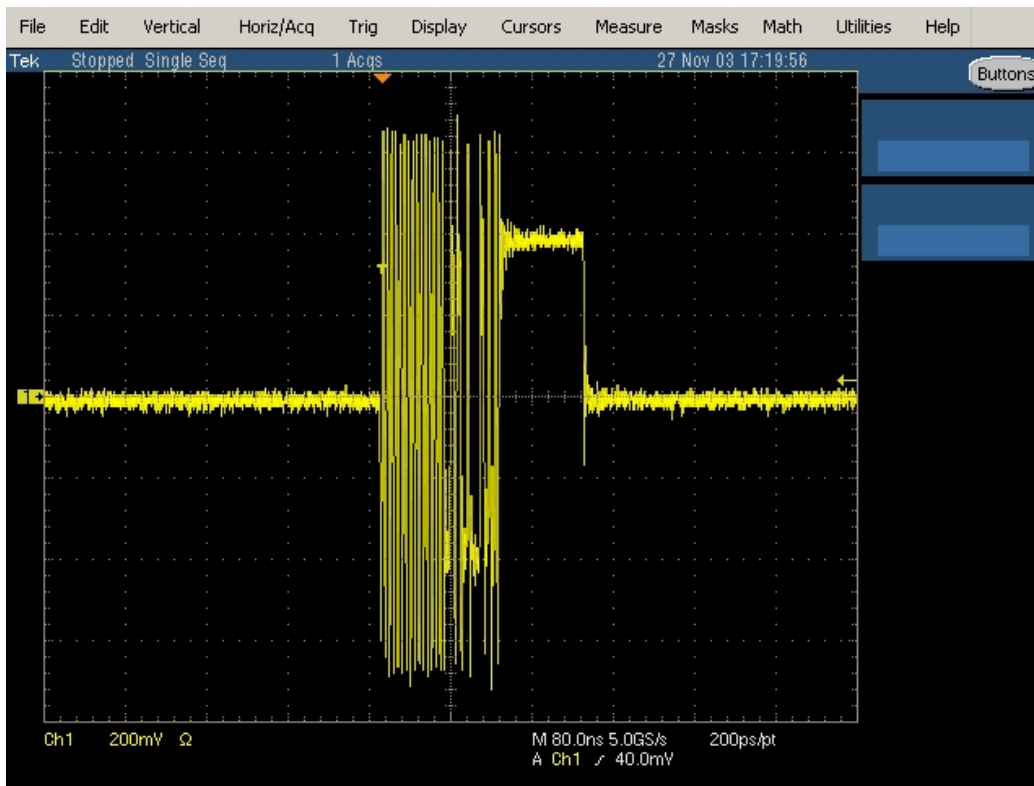

Figure 138: Viewing SOF

To set up the oscilloscope for the High Speed Device EL_21, EL_23, EL_25 (Sync-EOPIII-InterPacketII&III) and a High Speed Device EL_22 (InterPacketI&II), follow these steps:

1. Select the measurement and run the application. The application automatically sets the oscilloscope parameters (Horizontal, Vertical, and Trigger) and displays the message, "Press OK when correct waveform is acquired". You can see the SOFs on the oscilloscope screen.
2. If you are not able to acquire the waveform automatically, perform Autosetup in the oscilloscope to display the SOF.
3. If your DUT is EL_21, EL_23, EL_25, select the Single Step Set Feature option from the HS electrical test tool.
4. If your DUT is EL_22, select the Step button in the HS electrical test tool to acquire the waveform as shown in the following figure:

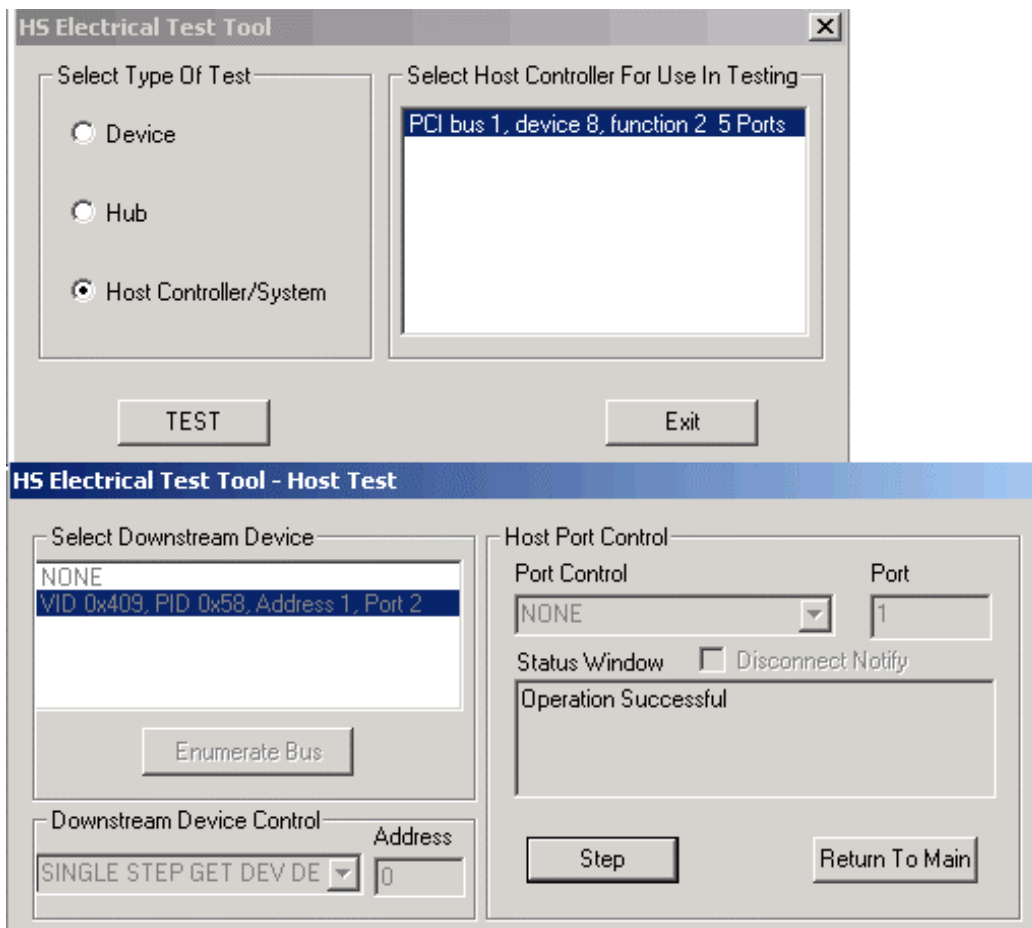

Figure 139: Setting the trigger level

You can use the application to perform the following measurements:

- High Speed Device:EL_21, EL_23, EL_25 (Sync-EOPIII-InterPacketII&III)
 - a. Complete procedures 1 and 3 to set up the oscilloscope.
 - b. The oscilloscope acquires and displays the waveform.
 - c. “Press OK when correct waveform is acquired”.
 - d. The application measures the synchronous bits (32) of the third packet. This is EL_21.
 - e. The application measures the EOP of the third packet (8bits). This is EL_25. As the signal is differential, the EOP can be a positive or a negative pulse.
 - f. The application measures the inter-packet gap between the second and the third packets (88-192 bits). This is EL_23 as shown in the following figure:

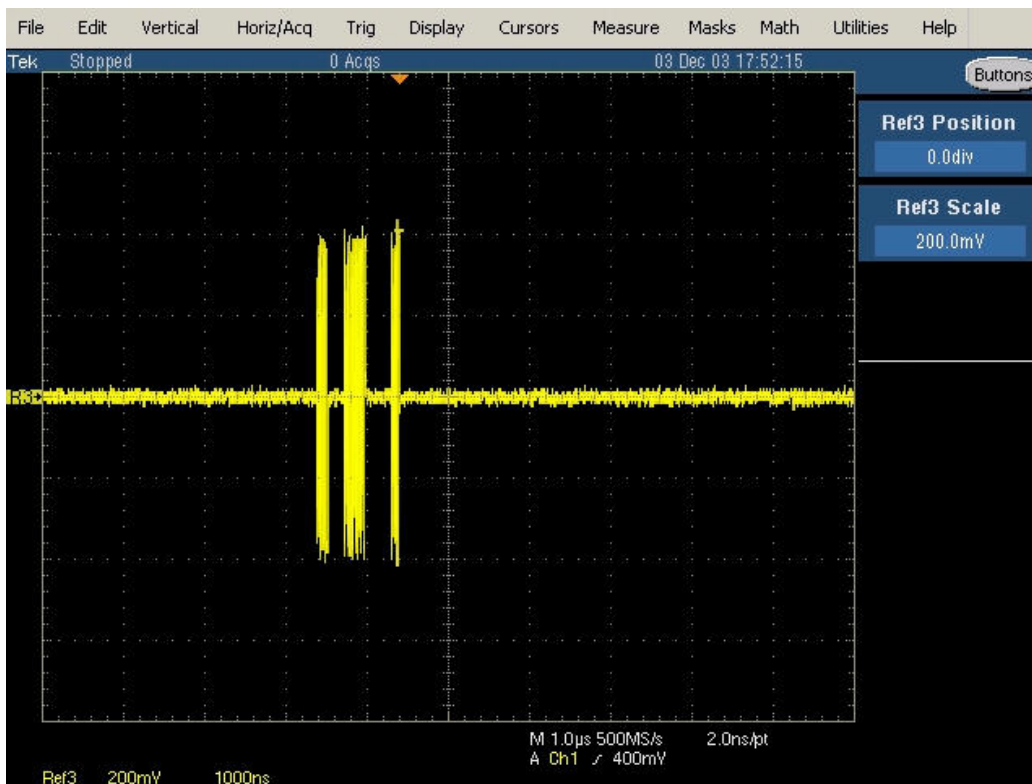

Figure 140: Measuring EL_23

- High Speed Device:EL_22 (InterPacketI&II)

- a. Complete procedures 1 and 3 to set up the oscilloscope.
- b. Select the Step button in the HS electrical test tool to acquire the waveform as shown in the following figure:

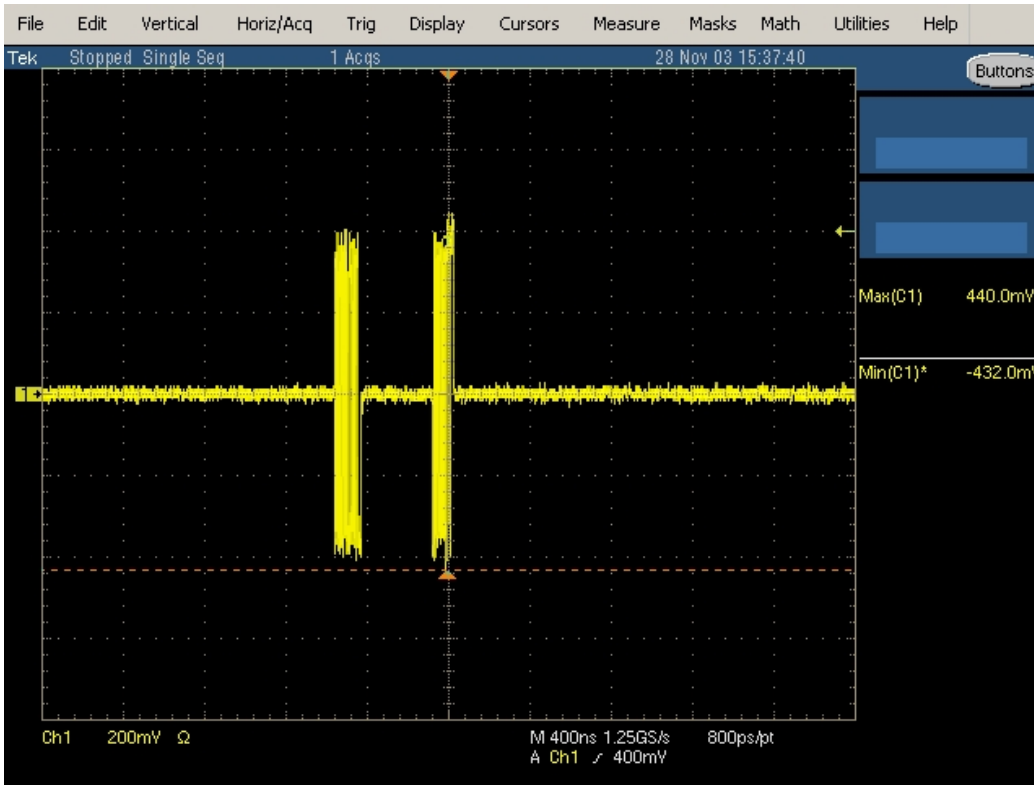

Figure 141: Acquiring the waveform

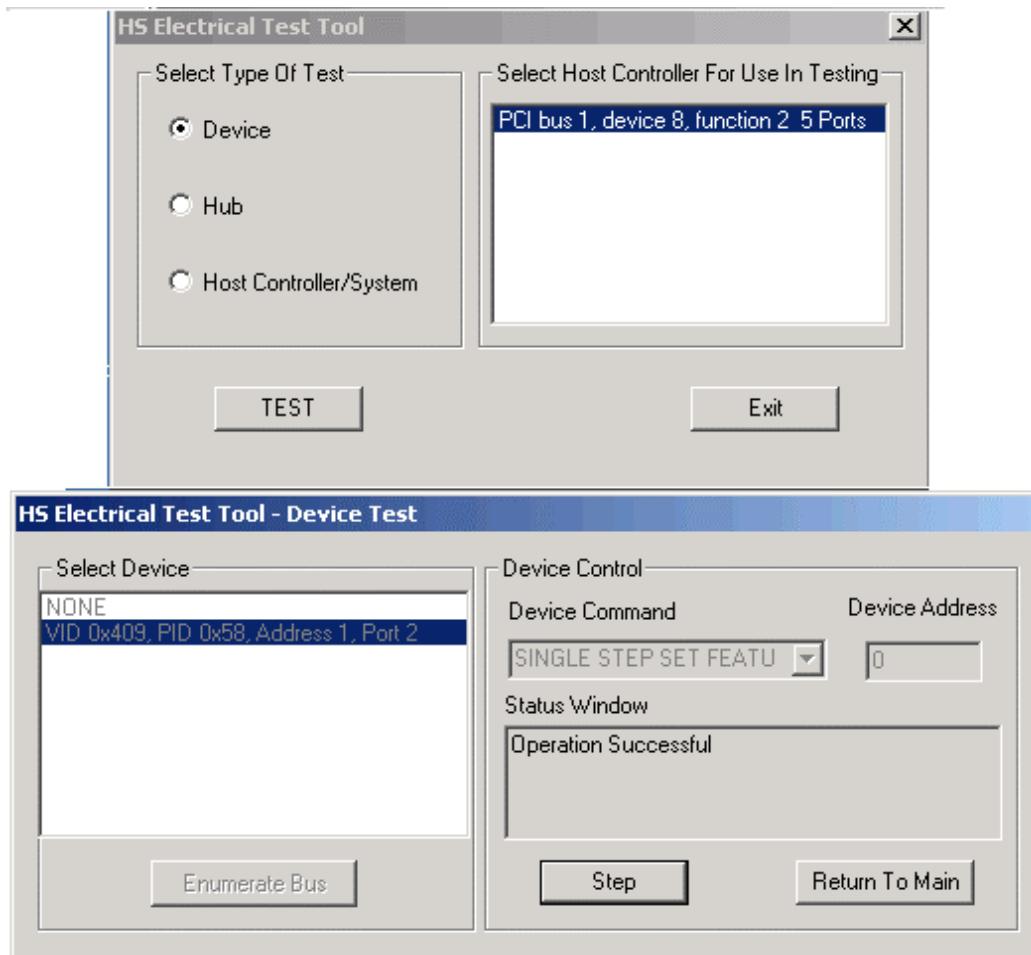

Figure 142: Setting the trigger level

- c. The application measures the number of bits (88-192) between the packets.

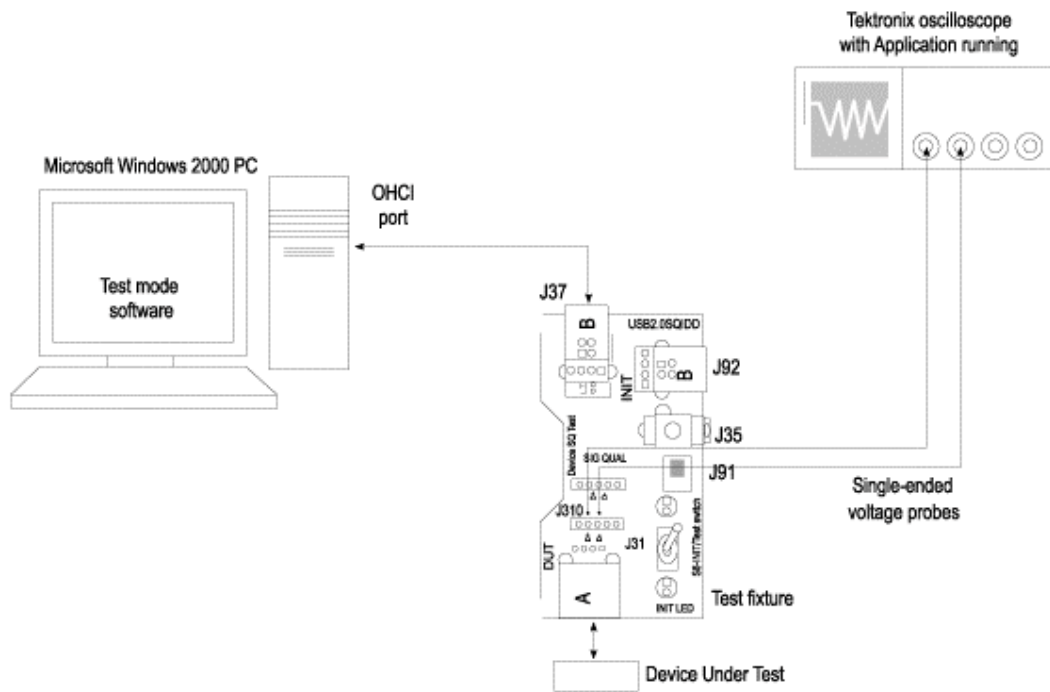

Figure 143: Equipment setup for Packet Parameter Measurement

Glossary

Cross-Over Points

The Cross-Over point is defined as the intersection of the D+ and D– single-ended signals. For differential signals, the Cross-Over is zero crossings of the differential signal.

Downstream

The direction of data flow from the host or away from the host. A downstream port is the port on a hub electrically farthest from the host that generates downstream data traffic from the hub. Downstream ports receive upstream data traffic.

EOP

End-of-Packet.

EOP (E), Idle (I), J, K

The different bus states of the USB signal.

Eye Pattern

A representation of the USB signal that provides minimum and maximum voltage levels, as well as the signal jitter.

Eye Violation

Any part of the waveform that crosses the defined eye mask.

Full-speed

USB operation at 12 Mb/s.

High-speed

USB operation at 480 Mb/s.

Host

The host computer system where the USB Host Controller is installed. This includes the host hardware platform (CPU, bus, etc.) and the operating system in use.

Host Controller

The host's USB interface.

Hot-Plug

It is the technology that supports automatic configuration of the PC hardware and the attached device. You can attach a device or hot plug and start working without having to manually configure the device. This is how it is referred to in the application.

HUT

A Host/Hub Under Test.

Hub

A USB device that provides additional connections.

Low-speed

USB operation at 1.5 mb/s.

mb/s

It is the transmission rate expressed in megabits per second.

NAK

A handshake packet indicating a negative acknowledgment.

Pulse Diagram

The Plot of the USB signals showing Annotations of J,K, EOP (E) , Idle (I), Cross-Over Points (Cov) and Reference Points (Ref).

Reference point

The simulation of ideal Cross-Over points, which helps calculate jitter.

Reflectometer

An oscilloscope capable of measuring impedance characteristics of the USB signal lines.

Sample Rate

It is the number of samples per second, expressed in Hertz (Hz).

Signal Direction Downstream

It is defined as the direction of data flow away from the host. A downstream port is the port on a hub farthest from the host that generates downstream data traffic from the hub. Downstream ports receive upstream data traffic.

Signal Direction Upstream

It is defined as the direction of data flow towards the host. An upstream port is the port on a device closest to the host that generates upstream data traffic from the hub. Upstream ports receive downstream data traffic.

Tier

The position in the hub where the device is connected to the system.

Test Point

A device is classified as far end or near end depending upon the captive cable. A device with captive cable is usually called as a far end device, otherwise as a near end device.

Test Fixture

It is the break-out board that helps in probing signals.

UUT

Called as the Unit Under Test. The unit can be a USB device, hub, port or a host.

Upstream

The direction of data flow is towards the host. An upstream port is the port on a device electrically closest to the host that generates upstream data traffic from the hub. Upstream ports receive downstream data traffic.

 V_{BUS}

It is the supply voltage which a function or hub requires to work.

